

State of Vermont
Agency of Natural Resources
Department of Environmental Conservation
Drinking Water and Groundwater Protection Division

Environmental Protection Rules

Chapter 1

Wastewater System and Potable Water Supply Rules

Effective: November 6, 2023

Department of Environmental Conservation (DEC)
Wastewater System and Potable Water Supply Regions and Regional Office Locations
<http://dec.vermont.gov/water/ww-systems>

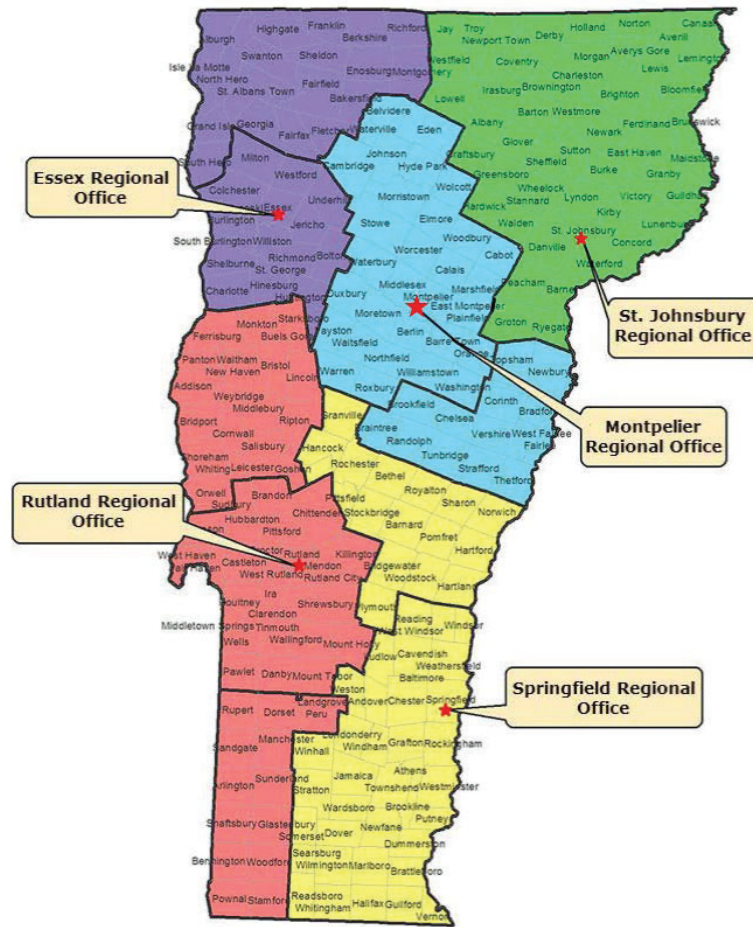

TABLE OF CONTENTS

Subchapter 1 – Purpose and Authority	1
§ 1-101 Purpose	1
§ 1-102 Authority	1
§ 1-103 Statewide Uniform Technical Standards	2
§ 1-104 Existing Municipal Permits Remain in Effect.....	2
§ 1-105 Severability.....	2
Subchapter 2 – Definitions	3
§ 1-201 Definitions	3
Subchapter 3 – Wastewater System and Potable Water Supply Permits.....	18
§ 1-301 Permit Required.....	18
§ 1-302 Permit Exemption for Reconstruction	20
§ 1-303 “Clean Slate” Permit Exemption	21
§ 1-304 Permit Exemptions	22
§ 1-305 Applications for Permits.....	31
§ 1-306 Site Plans, Supporting Information, and Design Certification.....	34
§ 1-307 Required Notification of Presumptive Isolation Zones	34
§ 1-308 Denial of an Application for a Permit	35
§ 1-309 Permit Conditions.....	36
§ 1-310 Filing of Permit	37
§ 1-311 Construction and Installation Certification	37
§ 1-312 Authorization to Commence with Site Work or Foundation Construction.....	39
§ 1-313 Additional Requirement for Replacement Systems and Replacement Supplies Permitted by Variance	40
Subchapter 4 – Approval of Innovative/Alternative Systems and Components.....	41
§ 1-401 Purpose and Decisions.....	41
§ 1-402 General Use Approval	42
§ 1-403 Pilot Approval	43
§ 1-404 Experimental Approval	43
§ 1-405 Application Process for Innovative/Alternative Systems and Components.....	44
§ 1-406 Renewal Application Process for Innovative/Alternative Systems and Components.....	46
§ 1-407Standards and Protocols for Testing Innovative/Alternative Systems and Components.....	46
Subchapter 5 – Administrative Reconsiderations; Appeals; Enforcement	48
§ 1-501 Administrative Reconsideration	48
§ 1-502 Appeal of Final Agency Decision	48
§ 1-503 Enforcement	49
Subchapter 6 – Delegation.....	50
§ 1-601 Full or Partial Delegation	50
§ 1-602 Process for Delegation.....	50
§ 1-603 Performance Expectations for a Delegated Municipality.....	51

§ 1-604	Agency Responsibilities	52
§ 1-605	Permit Fees and Enforcement Penalties	52
§ 1-606	Revocation of Delegation.....	53
Subchapter 7 – Designer Scope of Authority, Examination, and Continuing Education		55
§ 1-701	General Requirements	55
§ 1-702	Scope of Authority for Class 1 Designers and Professional Engineers	55
§ 1-703	Scope of Authority for Class A Designers	56
§ 1-704	Scope of Authority for Class B Designers	57
§ 1-705	Scope of Authority for Class BW Designers.....	58
§ 1-706	Examinations	59
§ 1-707	Continuing Education for Class A, B, and BW Designers.....	59
§ 1-708	Audit of Designers.....	60
Subchapter 8 – General Technical Standards for Wastewater Systems and Potable Water Supplies.....		61
§ 1-801	Basic Requirements.....	61
§ 1-802	Variances	62
§ 1-803	Design Flows	65
§ 1-804	Water Meter Data	76
§ 1-805	Wastewater Strength.....	79
§ 1-806	Determining Baseline Design Flow for Increases in Design Flow	80
Subchapter 9 – Specific Technical Standards for Wastewater Systems.....		82
§ 1-901	Use of Term Wastewater System	82
§ 1-902	Replacement Area	82
§ 1-903	General Requirements for Soil-Based Wastewater Systems.....	83
§ 1-904	Filtrate Effluent	90
§ 1-905	Water Table Monitoring.....	90
§ 1-906	Site Modifications	93
§ 1-907	2-year Time of Travel Management Zone	95
§ 1-908	Septic Tanks	96
§ 1-909	Grease Tanks	967
§ 1-910	Soil Evaluation	100
§ 1-911	Maximum Application Rates for Leachfields	102
§ 1-912	Horizontal Isolation Distances and Isolation Zones for Components of Wastewater Systems.....	103
§ 1-913	Wastewater System Presumptive Isolation Zone	112
§ 1-914	Dosing and Pressure Distribution.....	112
§ 1-915	Time Dosing	114
§ 1-916	Flow Equalization.....	115
§ 1-917	In-ground Trenches and Trenches in Mounds.....	116
§ 1-918	In-ground Beds and Beds in Mounds and Beds in Bottomless Sand Filters	118
§ 1-919	Additional Design Requirements for In-Ground Leachfields	120
§ 1-920	At-grade Leachfields	123
§ 1-921	Leachfields in Mounds	127
§ 1-922	Leachfields in Bottomless Sand Filters	131
§ 1-923	Leachfields Using Subsurface Drip Distribution	135

§ 1-924	Intermittent and Recirculating Sand Filters.....	136
§ 1-925	Constructed Wetlands.....	143
§ 1-926	Storage and Dose Approach to Wastewater Systems.....	143
§ 1-927	Simplified Method of Completing a Hydrogeological Analysis.....	144
§ 1-928	Holding Tanks	145
§ 1-929	Disposal of Contents of Composting or Incinerating Toilets.....	148
§ 1-930	Discontinuing Use and Removal of a Wastewater System	148

Subchapter 10 – Flexible Specific Technical Standards for Wastewater Systems 150

§ 1-1001	Request for Alternative Technical Standard	150
§ 1-1002	General Requirements for Sanitary Sewer Service Lines	150
§ 1-1003	General Requirements for Sanitary Sewer Collection Lines.....	152
§ 1-1004	Requirements for Sanitary Sewer Manholes	158
§ 1-1005	Requirements for Inverted Siphons.....	160
§ 1-1006	Design Standards for Sanitary Sewer Collection Lines and Sanitary Sewer Service Lines Under and Over Surface Waters.....	161
§ 1-1007	Separation of Sanitary Sewer Service Lines and Sanitary Sewer Collection Lines from Water Mains, Water Service Lines and Water Service Pipes.....	162
§ 1-1008	Requirements for Wastewater Pump Stations	164
§ 1-1009	Requirements for Force Mains	173
§ 1-1010	Requirements for Testing of Tanks for Watertightness	175

Subchapter 11 – Specific Technical Standards for Potable Water Supplies 176

§ 1-1101	Use of Term Potable Water Supply.....	176
§ 1-1102	General Requirements for Potable Water Supplies and Water Service Lines	176
§ 1-1103	Source Siting Requirements	177
§ 1-1104	Horizontal Isolation Distances and Isolation Zones for Components of Potable Water Supplies	177
§ 1-1105	Potable Water Supply Presumptive Isolation Zone.....	184
§ 1-1106	Grouting Annular Space.....	184
§ 1-1107	Long-Term Yield Analysis.....	185
§ 1-1108	Interference Testing and Analysis.....	186
§ 1-1109	Instantaneous Peak Demand.....	188
§ 1-1110	Water Storage and Water Storage Tanks	189
§ 1-1111	Pumps	191
§ 1-1112	Cross Connections.....	192
§ 1-1113	Water Quality	193
§ 1-1114	Flowing Artesian Well	196
§ 1-1115	Closure of Potable Water Sources.....	197

Subchapter 12 – Flexible Specific Technical Standards for Potable Water Supplies 199

§ 1-1201	Request for Alternative Technical Standard	199
§ 1-1202	General Requirements for Water Service Lines and Water Service Pipes.....	199
§ 1-1203	Design Standards for Water Service Lines and Water Service Pipes Under and Over Surface Water	200
§ 1-1204	Separation of Water Service Lines and Water Service Pipes from Sanitary Sewer Service Lines, Sanitary Sewer Collection Lines, and Storm Sewers	201
§ 1-1205	Potable Water Source Design and Construction	203

§ 1-1206	Potable Water Sources in Bedrock, Confined Surficial Aquifers, and Unconfined Surficial Aquifers	207
§ 1-1207	Pipes and Pumps.....	208
§ 1-1208	Requirements for Water Storage Tanks	209
§ 1-1209	Leakage and Pressure Testing	211
§ 1-1210	Disinfection	211
Appendix A – Information for an Application.....		213
Appendix B – Examples.....		219
Examples B-1	Examples for Designing a Flow Equalization Tank.....	219
Examples B-2	Examples for Calculating the Induced Water Table Using the Simplified Method	219
Appendix C – Typical Details and Examples		222
Figure C-1	Example of 50-foot Calculation for Reconstruction	222
Figure C-2	Detail of Typical Groundwater Monitoring Well.....	223
Figure C-3	Detail of Typical Site that was Re-Graded.....	224
Figure C-4	Example for Drawing Isolation Zone Around a Drinking Water Source.....	225
Figure C-5	Detail of Typical Time Dosing Pump Station.....	226
Figure C-6	Detail of Typical Shallow Trench Wastewater System.....	227
Figure C-7	Detail of Typical Trench Wastewater System With 24 Inches of Limiting Soil	228
Figure C-8	Detail of Typical Trench Wastewater System With 24 Inches to 5 Feet of Limiting Soil.....	229
Figure C-9	Detail of Typical At-Grade Leachfield with One Infiltration Area (0-3 % Site Slope).....	230
Figure C-10	Detail of Typical At-Grade Leachfield with Two Infiltration Areas (> 3 % Site Slope).....	231
Figure C-11	Detail of Typical At-Grade Leachfield with Interfingering Infiltration Areas (> 3 % Site Slope)	232
Figure C-12	Detail of Typical Bed in a Mound.....	233
Figure C-13	Detail of Typical Leachfield in a Bottomless Sand Filter	234
Figure C-14	Detail of Typical Leachfield using Subsurface Drip Distribution	235
Figure C-15	Example for Drawing Isolation Zone Around a Leachfield.....	236
Figure C-16	Detail of Typical Drilled Bedrock Well	237
Figure C-17	Detail of Typical Driven Well.....	238
Figure C-18	Detail of a Typical Dug Well or Spring	239

Subchapter 1 – Purpose and Authority

§ 1-101 Purpose

The purpose of these Rules is to:

- (1) establish a comprehensive program to regulate the design, construction, replacement, modification, operation, and maintenance of potable water supplies and wastewater systems in order to protect human health and the environment including protecting potable water supplies, public water systems, surface water, and groundwater;
- (2) prevent the creation of health hazards or unsanitary conditions;
- (3) ensure adequate effluent dispersal and drainage for the proper functioning of wastewater systems;
- (4) ensure that potable water supplies and wastewater systems are designed, constructed, operated, and maintained in a manner that supports the intended use of the supplies and systems with respect to reliability, incremental costs, and sustainability;
- (5) ensure that owners of potable water supplies and wastewater systems permitted under these Rules have knowledge of their systems' design, the operation and maintenance requirements, and their responsibilities for the satisfactory functioning of the supplies and systems;
- (6) allow the use of alternative, innovative, and experimental technologies for the treatment and disposal of wastewater in the appropriate circumstances;
- (7) protect the investment of homeowners through a flexible remediation process for failed potable water supplies and wastewater systems; and
- (8) increase reliance on and the accountability of the private sector for the design and installation of potable water supplies and wastewater systems through licensing and enforcement.

§ 1-102 Authority

- (a) These Rules are adopted by the Secretary under the authority of the Secretary granted by 10 V.S.A., Chapters 47, 56, and 64, and 10 V.S.A. §§ 901, 905b, 1390, 6616.
- (b) These Rules supersede the existing Wastewater System and Potable Water Supply Rules which were effective on September 29, 2007.
- (c) The provisions of these Rules that regulate potable water supplies supersede all provisions of the Water Supply Rule, effective December 1, 2010, that apply to potable water supplies insofar as they apply to such supplies.
- (d) These Rules do not supersede or otherwise affect other existing regulations, including Vermont Department of Health regulations and the Vermont Plumbing Rules. No provision in these Rules limits the authority of the Vermont Department of Health to license facilities under its jurisdiction.

- (e) These Rules do not limit the powers of state or local authorities to control existing or potential threats to human health or the environment or limit the exercise of other authorities to regulate human health, safety, and welfare, except as provided in § 1-103.

§ 1-103 Statewide Uniform Technical Standards

- (a) After June 30, 2007, those provisions of existing municipal ordinances and zoning bylaws that establish technical standards for the design, construction, operation, and maintenance of potable water supplies and wastewater systems are superseded (i.e. no longer in effect) by the technical standards of these Rules.
- (b) Municipalities may continue to have ordinances or bylaws that do not establish technical standards, for example, ordinances or bylaws that:
 - (1) are not specifically regulating potable water supplies or wastewater systems but rather regulating development in general (e.g., setbacks);
 - (2) require submission to the municipality of copies of plans and documents used to obtain a state permit under these Rules;
 - (3) require a certificate of occupancy that is based on full compliance with a state permit issued under these Rules;
 - (4) require notice of, and have the option to observe, any soil testing such as the digging of test pits conducted in support of a permit application;
 - (5) require notice of, and have the option to observe, construction of a permitted wastewater system or potable water supply;
 - (6) determine where connections can be made to wastewater treatment facilities and public water systems; and
 - (7) require time of sale inspections.

§ 1-104 Existing Municipal Permits Remain in Effect

Notwithstanding the fact that local ordinances and bylaws are superseded after June 30, 2007 as described in § 1-103, all permits issued under those municipal ordinances or bylaws, provided the ordinances or bylaws established specific technical standards for the design, construction, operation, and maintenance of the permitted potable water supplies and wastewater systems, shall remain in effect unless and until such permit is superseded by another permit issued under the provisions of these Rules.

§ 1-105 Severability

The provisions of these Rule are severable. If any provision of these Rules is found to be invalid, or if any application of these Rules to any person or circumstance is found to be invalid, the invalidity shall not affect other provisions that can be given effect in the absence of the invalid provision or application.

Subchapter 2 – Definitions

§ 1-201 Definitions

As used in these Rules, the following terms shall have the specified meaning.

- (1) **Aquifer** – means a water bearing stratum of permeable bedrock, sand, gravel, or other soil.
- (2) **Agency** – means the Agency of Natural Resources.
- (3) **Alternative Hand Washing Supplies** – means pre-moistened towelettes, hand sprays, or hand sanitizer gels.
- (4) **Alternative Toilet** – means a unit that has a toilet and is self-contained (i.e., includes a holding tank to store the wastewater generated by use of the unit), is portable, is brought to a site for temporary use, and meets one of the following descriptions:
 - (A) a unit that contains a waterless toilet and a holding tank to capture waste from the toilet and either contains alternative hand washing supplies or is located near a portable sink brought to the site for temporary use with a water tank to supply water to the sink and a holding tank to capture waste from the sink;
 - (B) a unit that contains one or more waterless toilets, sinks, water tanks to supply water to the sinks, and holding tanks to capture waste from the sinks and toilets; or
 - (C) a unit that contains one or more toilets, sinks, water tanks to supply water to the sinks and toilets, and holding tanks to capture the waste from the sinks and toilets.
- (5) **Applicant** – means a person who owns the lot on which is or will be located the building or structure or campground that is or will be served by the wastewater system and potable water supply for which a permit or permit amendment is sought.
- (6) **Artesian Well** – means a well that penetrates a confined aquifer such that the water level in the well rises above the top of the aquifer.
- (7) **Base Flood** – means base flood as defined in the Vermont Flood Hazard Area and River Corridor Rule.
- (8) **Base Flood Elevation** – means base flood elevation as defined in the Vermont Flood Hazard Area and River Corridor Rule.
- (9) **Bed** – means a leachfield that is a shallow excavation in the ground, or mound fill material, more than 48 inches wide that is lined with leachfield stone, contains chambers, or utilizes other dispersal method, and that releases wastewater into the soil through perforated distribution pipes.

- (10) **Bedrock** – means igneous, metamorphic, or sedimentary rock regardless of whether it underlies soil or is exposed at ground surface. For the purpose of wastewater system design, bedrock includes weathered rock that is not soil.
- (11) **Bedroom** – except where otherwise specified in these Rules, means any room within a building or structure that is permitted, used, or serves as sleeping quarters.
- (12) **Biochemical Oxygen Demand (BODs)** – means the quantity of oxygen used in the biochemical oxidation of organic matter in five days at 20 degrees Celsius under specified conditions and reported as milligrams per liter (mg/L).
- (13) **Building or Structure** – means a building or structure whose use or useful occupancy requires the construction or modification of a potable water supply or wastewater system.
- (A) For the purposes of these Rules, the following are buildings or structures:
- (i) A primitive camp.
 - (ii) A recreational vehicle, or vehicle used for commercial purposes, and modified in one of the following ways, unless the vehicle is on a campsite in a campground:
 - (I) placing skirting or insulation around the base of the vehicle;
 - (II) placing the vehicle unit on a foundation or removing the wheels;
 - (III) attaching a deck or stairs to the vehicle;
 - (IV) making the vehicle immobile in any way that inhibits the vehicle from being driven off the lot in order to fill the water holding tank and empty the wastewater holding tank;
 - (V) connecting the vehicle to a potable water supply or wastewater system;
 - (VI) the vehicle, although qualifying as a vehicle, cannot travel over Vermont roads without a special permit; or
 - (VII) occupying a vehicle that is not registered and inspected to travel on the roads.
- (B) For the purposes of these Rules, a cabin located on a campsite in a campground is not a building or structure.
- (C) For the purposes of these Rules, a remote hut used by outdoor recreationists with no connection to a water source, no connection to a wastewater system (other than a composting or incinerating toilet that does not yield a liquid, provided its contents are disposed of in compliance with § 1-929), and accessible only by foot or water, is not a building or structure.
- (D) Examples of other buildings or structures: single-family residences; accessory apartments; duplexes; yurts; yomes; cabins; multi-unit buildings; condominiums; apartments; mobile homes; hospitals; nursing homes; motels; hotels; restaurants; filling stations; boarding houses; rooming houses; dormitories; stores or shops; buildings or structures used

as places of public assembly, places of employment, or home occupations; offices; manufacturing facilities; industrial facilities; and farm buildings or structures.

- (14) **Campground** – means 4 or more campsites on a lot that are occupied or made available to be occupied for vacation or recreational purposes by camping units, such as tents, yurts, tepees, lean-tos, camping cabins, and recreational vehicles. There shall be no distinction made between non-commercial (no charge, no service) and commercial operations.
- (15) **Campsite** – means an area that is occupied or made available to be occupied for vacation or recreational purposes by a camping unit, such as a tent, yurt, tepee, lean-to, cabin, or recreational vehicle, but does not include an area used only for primitive camping. For the purposes of this definition “primitive camping” means camping that involves temporary overnight occupancy in a natural environmental setting without a potable water supply, a wastewater system, picnic tables, or other developed structures or facilities and that is left in its original condition upon vacancy such that there is no, or minimal, evidence of human visitation. A campsite may rely on water faucets, central toilet facilities, or a dumping station or may have individual water service lines and sanitary sewer service lines.
- (16) **Child Care Facility** – means a child care facility registered or licensed by the Vermont Agency of Human Services, Department for Children and Families pursuant to 33 V.S.A., Chapter 35. Child care facilities include registered or licensed family child care homes.
- (17) **Change in Use** – means converting to a different type of use, such as from a residence to a restaurant or office space or from a restaurant to a residence; change from seasonal to year-round use; or scaling up a use, such as increasing the number of employees or adding bedrooms. Change of use does not include the addition of a home occupation to a living unit.
- (18) **Commissioner** – means the Commissioner of the Department or their designated representative.
- (19) **Confined Surficial Aquifer** – means an aquifer that is not in bedrock, is overlain by a low permeability layer, and contains groundwater under pressure such that the water level in a well that penetrates the aquifer rises above the top of the aquifer.
- (20) **Constant Rate Discharge Test** – means a test of a water source that is pumped for a specified duration at one flow rate, expressed in gallons per minute, to determine the yield of the source, aquifer characteristics, or source interference.
- (21) **Department** – means the Department of Environmental Conservation.

- (22) **Dependent Campsite** – means a campsite that does not provide for the ability of a camping unit or recreational vehicle to physically connect to a wastewater system and a potable water supply.
- (23) **Design Flow** – in reference to a particular component of a wastewater system or potable water supply, means the quantity of wastewater or water, calculated in gallons per day, that is required for all uses of each building or structure or campground to be served by the component and which, in total, dictates the sizing of the component. Individual components of a wastewater system or potable water supply can have design flows distinct from other components’ design flows.
- (24) **Design Rate** – means the rate of flow, calculated in gallons per minute, that needs to be delivered by a potable water supply. Design rate is determined by dividing the design flow by 720 minutes.
- (25) **Designer** – means a person licensed by the Office of Professional Regulation under 26 V.S.A., Chapter 97 as a wastewater system and potable water supply designer or professional engineers who are Class 1 Designers.
- (26) **Director** – means the Director of the Division or their designated representative.
- (27) **Division** – means the Drinking Water and Groundwater Protection Division of the Department.
- (28) **Effective Basal Area** – means the area of naturally occurring soil that is directly beneath and downslope of the leachfield within the mound.
- (29) **Elevation** – means the vertical position of a specified object or geologic feature relative to an established vertical benchmark. The benchmark may be established by the designer, or may be established by others, such as the U.S. Geological Survey datums. When working with plans or maps prepared by others, the related benchmark must be used to interpret those plans or maps.
- (30) **Employee** – means paid or unpaid staff including volunteers that regularly constitute a portion of the staff.
- (31) **Failed Supply** – means:
- (A) a potable water supply:
- (i) that has been tested for the following contaminants, in accordance with the protocols approved by the Secretary, and is found not to comply with the specified standard for one or more of the contaminants:
- | | | |
|-------|---------------------------|-------------------------------|
| (I) | Arsenic | 0.010 mg/L; |
| (II) | Escherichia coli (E.coli) | None (absent or less than 1); |
| (III) | Total Coliform | None (absent or less than 1); |
| (IV) | Fluoride | 4 mg/L; |

(V)	Lead	0.015 mg/L;
(VI)	Manganese	0.3 mg/L;
(VII)	Nitrate	10 mg/L;
(VIII)	Nitrite	1 mg/L;
(IX)	Uranium	20 ug/L (0.02 mg/L); and
(X)	Adjusted Gross Alpha Particle Activity (including radium 226/228 but excluding radon and uranium)	15 pCi/L

- (ii) that the Secretary affirmatively determines is not potable due to the presence of a contaminated site, a leaking underground storage tank, or other known sources of groundwater contamination or naturally occurring contaminants, and such determination has been posted on the Agency website; or
- (iii) that the Secretary affirmatively determines is providing an insufficient quantity of water to maintain the usual and customary uses of a building or structure or campground or to maintain its uses permitted in a wastewater system and potable water supply permit, and such determination has been posted on the Agency website.

- (B) Notwithstanding the provisions above, a potable water supply shall not be a failed supply if:
 - (i) these effects can be and are remedied solely by a minor repair or minor replacement; or
 - (ii) these effects have lasted for only a brief period of time, the cause of the failure has been determined to be an unusual and non-recurring event, and the supply has recovered from the state of failure. Supplies which have recurring, continuing, or seasonal failures shall be considered to be failed supplies.

(32) **Failed System** – means:

- (A) a wastewater system that is functioning in a manner:
 - (i) that allows wastewater to be exposed to the open air, to pool on the surface of the ground, to discharge directly to surface water, or to back up into a building or structure, unless in any of these instances the approved design of the system specifically requires the system to function in such a manner; or
 - (ii) that results in a potable water supply being affirmatively determined by the Secretary to be a failed supply and such determination has been posted on the Agency website.
- (B) Notwithstanding the provisions above, a system shall not be a failed system if:
 - (i) these effects can be and are remedied solely by a minor repair or minor replacement; or
 - (ii) these effects have lasted for only a brief period of time, the cause of the failure has been determined to be an unusual and non-recurring event, and the system has recovered from the state of

failure. Systems that have recurring, continuing, or seasonal failures shall be considered to be failed systems.

- (33) **Family Child Care Home** – means a child care facility registered or licensed by the Vermont Agency of Human Services, Department for Children and Families as a family child care home.
- (34) **Filtrate Effluent** – means effluent that has been treated to reduce BOD₅ to 30 mg/L or less and total suspended solids (TSS) to 30 mg/L or less.
- (35) **Floodway** – means floodway as defined in the Vermont Flood Hazard Area and River Corridor Rule.
- (36) **Flood Hazard Area** – means flood hazard area as defined in the Vermont Flood Hazard Area and River Corridor Rule.
- (37) **Flowing Artesian Well** – means an artesian well that penetrates a confined bedrock aquifer or surficial aquifer such that the water level in the well rises above ground surface.
- (38) **Food Processing Waste** – means wastewater that is generated from the manufacturing of a food or beverage product and that consists of washwater or residual food or beverage waste from food processing facilities making such products as dairy products, beer, wine, spirits, maple syrup and candy, and microwave dinners. “Food processing waste” does not include waste from slaughterhouse facilities or rendering operations, wastewater associated with the washing of unaltered fruits, vegetables or other farm produce, or food or food preparation wastewater from food markets, grocery stores, food store, delis or restaurants.
- (39) **Ground Slope** – means the slope of the ground surface.
- (40) **Ground Surface** – means the elevation of the naturally occurring soil.
- (41) **Groundwater** – means water below the ground surface in a zone of saturation.
- (42) **Home Occupation** – means a business, profession, occupation, or trade conducted for gain or support within a living unit, or in a detached structure located on the same lot as the living unit, provided the home occupation is incidental and secondary to the residential use of the living unit; is conducted by an occupant of the living unit; has no employees except for family members who are occupants of the living unit; does not provide clients, customers, or other members of the public access to the potable water supply or wastewater system serving the living unit; and is not required by any state or federal agency to provide clients, customers, or other members of the public with access to a potable water supply or wastewater system. A child care facility is not a home occupation.

- (43) **Hydrofracturing** – means a method of bedrock well development used to increase the yield of wells in which high pressures are generated in the well to open fractures. Propping agents may be introduced to keep the fractures open.
- (44) **Hydrogeologist** – means a person with training or experience in bedrock geology, surficial geology, and groundwater hydrology sufficient to prepare the hydrogeologic studies and analyses required by these Rules.
- (45) **Impeding Soil Layer** – means a naturally occurring soil layer with a thickness of at least 8 feet and a soil texture of sandy clay, silty clay, or clay with any structure, or, sandy clay loam, silty clay loam, or clay loam with massive or platy structure.
- (46) **Improved Lot** – means a lot on which exists a campground or a substantially completed building or structure and an associated substantially completed potable water supply and wastewater system that may or may not be located on the lot.
- (47) **Indirect Discharge System** – means an indirect discharge, as defined in the Indirect Discharge Rules, that is issued a discharge permit pursuant to the Indirect Discharge Rules. Indirect discharge systems include pollution abatement facilities that engage in the indirect discharges of waste.
- (48) **Induced Water Table** – means the rise in the seasonal high-water table caused by the discharge of wastewater into a soil-based wastewater system. For the purposes of this definition, “seasonal high-water table” means the seasonal high-water table prior to use of a curtain drain except when the curtain drain complies with the requirements of § 1-906(a) and the water table is monitored pursuant to § 1-905.
- (49) **Injection well** – means an injection well as defined in the Underground Injection Control Regulations, the discharge to which is issued a discharge permit, or is otherwise permitted, pursuant to the Underground Injection Control Regulations.
- (50) **Installer** – means a person who constructs a potable water supply or wastewater system serving or intended to serve a building or structure, or campground.
- (51) **Instantaneous Peak Demand** – means the maximum rate of water that needs to be supplied to meet the fixture unit demand, based on the load values assigned to plumbing fixtures determined by the Vermont Plumbing Rules or determined by these Rules, of a potable water supply. The rate is expressed in gallons per minute.
- (52) **Inverted Siphon** – means a depressed sanitary sewer collection line designed to flow full and under pressure.
- (53) **Kitchen** – means the common plumbing fixtures and appliances normally expected in the food preparation area of a living unit. This includes, at a minimum, the combination of a sink, a refrigerator, and cooking facilities.

Cooking facilities include stoves, built-in ovens, counter top ovens, microwave ovens, and similar appliances.

- (54) **Land Surveyor** – means a land surveyor licensed by the Board of Land Surveyors under 26 V.S.A., Chapter 45.
- (55) **Leachfield** – means that portion of a soil-based wastewater system used to disperse wastewater into the soil.
- (56) **Leachfield Stone** – means clean, screened, durable stone no smaller than $\frac{3}{4}$ inch and no larger than 1-1/2 inch in diameter. For the purposes of this definition, “clean stone” means stone with no more than 1.5 percent of fines passing the #200 sieve as determined using the AASHTO test method T 11-85 and “durable stone” means stone that has a hardness value of three or greater on the Moh’s Scale of Hardness.
- (57) **Linear Loading Rate** – means the amount of wastewater measured in gallons per day that may be applied to each linear foot of the overall length of a leachfield as measured along the ground contour.
- (58) **Living Unit** – means a building or structure or a portion of a building or structure that has a toilet, sink, kitchen, and one or more bedrooms, and that is reasonably private and separated from other living units. A second, detached building or structure that contains a toilet, sink, or one or more bedrooms, but does not contain a kitchen, is not a separate living unit. Examples of buildings or structures that contain more than one living unit are duplexes and single-family residences with an accessory apartment.
- (59) **Long-Term Yield** – means the quantity of water that may flow or be pumped continuously from a source over a specified length of time.
- (60) **Lot** – means a tract or portion of land with defined boundaries created by the act of subdivision. A deed may describe one or more lots. Multiple lots described in a single deed remain separate lots provided that they are described as having separate and distinct boundaries and that any subsequent deed describing the lots does not specifically eliminate the separate and distinct boundaries.
- (61) **Mean Water Level** – means mean water level as defined in the Rules Determining Mean Water Levels.
- (62) **Minimum Site Conditions** – means those naturally occurring conditions related to soil permeability, soil depth, depth to seasonal high-water table, soil depth to bedrock and slope that must exist in order to construct any soil-based wastewater system. This definition also means the limits for siting in a floodway or floodplain.
- (63) **Minor Repair or Minor Replacement** – means:
 - (A) For wastewater systems, the:

- (i) repair or replacement of a pipe leading from a building or structure or campground to the septic tank or from the septic tank to the leachfield, not including piping within the leachfield, in the same approximate location;
- (ii) replacement of a portion of a distribution pipe in a leachfield when a designer concludes the leachfield is not a failed system, there is no removal of leachfield stone beneath the distribution pipe, and the pipe is crushed or otherwise preventing wastewater from flowing to other portions of the leachfield;
- (iii) replacement of a sanitary sewer service line or sanitary sewer collection line in the same approximate location;
- (iv) replacement of a septic tank;
- (v) replacement of a distribution box;
- (vi) repair or replacement of a pump or associated valves, switches and controls; or
- (vii) any other repair or replacement that the Secretary, on a case by case basis, determines to be a minor repair or minor replacement.

For the purposes of this definition, “same approximate location” means within 10 feet of its original location and no closer horizontally to a public water source, a potable water source, water service line, or water service pipe, or water main. The addition of an innovative/alternative component to a wastewater system or the removal of an existing or permitted innovative/alternative component and replacement with a different innovative/alternative component is not a minor repair or minor replacement.

(B) For potable water supplies:

- (i) the repair or replacement of a water service pipe in the same approximate location;
- (ii) replacement of a water service line in the same approximate location;
- (iii) repair or replacement of a pump;
- (iv) repair or replacement of filters or screens;
- (v) repair or replacement of a mechanical component;
- (vi) repair or reconstruction of a driven well point in approximately the same location;
- (vii) hydrofracturing a potable water source;
or
- (viii) any other repair that the Secretary, on a case by case basis, determines to be a minor repair or minor replacement.

For the purpose of this definition, “same approximate location” means within 10 feet of its original location and no closer horizontally or vertically to a sanitary sewer service line, sanitary sewer collection line, or any other portion of a wastewater system.

(C) The following are not minor repairs or replacements:

- (i) installation of a water treatment system;
- (ii) replacement of a distribution system; and

- (iii) any action, including replacement of piping related to a change in use, that increases design flow or modifies other operational requirements of the potable water supply or wastewater system.

- (64) **Mobile Home** – means a living unit that:
 - (A) is designed for long term and continuous residential occupancy;
 - (B) is designed to be moved on wheels, as a whole or in sections;
 - (C) on arrival at the site, is complete and ready for occupancy, except for incidental unpacking, assembly, connections with utilities, and placing on supports or a permanent foundation, or installation as a unit in a previously prepared structure; and
 - (D) contains the same type of interior plumbing fixtures as immovable housing (not recreational vehicle-type fixtures).

- (65) **Modifies Operational Requirements** – means the need to apply new technical standards from these Rules. Examples of actions that modify operational requirements:
 - (A) Installation and use of a water treatment system to a potable water supply unless exempt under § 1-304(19) or (20).
 - (B) Installation and use of an innovative/alternative system or component for a potable water supply or wastewater system that has or requires approval pursuant to Subchapter 4.
 - (C) Installation and use of a composting or incinerator toilet.
 - (D) Installation of a flush toilet to replace a composting or incinerator toilet.
 - (E) Conversion to a restaurant or food preparation business requiring the installation of a grease tank.
 - (F) Conversion to a brewery from a different use identified in Table 8-3.
 - (G) Addition of a fire suppression system that requires upgrading of the water service line.
 - (H) Change in use of a single-family residence from seasonal to year-round.
 - (I) Change in the use of a building or structure when the proposed use does not appear on Table 8-3 and the proposed wastewater does not meet the specifications for low strength wastewater pursuant to § 1-805(b).
 - (J) Change in the use of a building or structure that produces a waste or wastewater identified in § 1-301(e) which will be treated and disposed of via a wastewater system serving the building or structure.
 - (K) Adding plumbing fixtures that increase the demand on the potable water supply that is not connected to a public water system by more than 10 fixture units, using the load values assigned to plumbing fixtures determined by the Vermont Plumbing Rules, to a building or structure thereby increasing the project’s instantaneous peak demand.
 - (L) Installation of a pump station, dosing siphon, or floating outlet dosing system to a wastewater system.
 - (M) Installation of an atmospheric water storage tank to serve one single-family residence that is served by a potable water source that serves no other buildings or structures and no campground.

- (66) **Municipality** – means a city, town, fire district, school district, consolidated water district, incorporated village, or unorganized town or gore.
- (67) **Naturally Occurring Soil** – means soil that does not contain evidence of human-alteration or human-transport other than wide-area, uniform, shallow modification such as tilling.
- (68) **Normal High-Water Elevation** – means the boundary of any surface water that delineates the highest water elevation that has been maintained for a sufficient period of time to leave evidence upon the landscape, commonly the point where the natural vegetation changes from predominantly aquatic or no vegetation to predominantly terrestrial. For streams, the normal high-water elevation is the elevation of the top of the bank of the channel that is not the floodway. For reservoirs, the normal high-water elevation is the operating elevation of the normal summer pool. For streams, when the normal high-water elevation shows signs of eroding, the normal high-water elevation for the purposes of these Rules shall be the limits of erosion.
- (69) **Permanent Legal Access** – means an easement, right of way, deed, or other legal document that creates an enforceable permanent property interest of access to and use of land for a designated purpose.
- (70) **Perched Water Table** – means the upper surface of a zone of saturation held above a less permeable layer which is underlain by an unsaturated zone and the main water table.
- (71) **Person** – means any individual, partnership, company, corporation, association, unincorporated association, joint venture, trust, municipality, the state of Vermont or any agency, department or subdivision of the state, federal agency, or any other legal or commercial entity.
- (72) **Potable Water Source** – means a component of a potable water supply that withdraws or collects water from soil or bedrock. Potable water sources include springs; drilled, driven, or dug wells; and surface water.
- (73) **Potable Water Supply** – means the source, treatment, and conveyance equipment used to provide water used or intended to be used for human consumption, including drinking, washing, bathing, the preparation of food, or laundering. This definition does not include any internal piping or plumbing except for mechanical systems, such as pump stations and storage tanks or lavatories, that are located inside a building or structure and that are integral to the operation of a potable water supply. This definition also does not include a potable water supply that is subject to regulation under 10 V.S.A. Chapter 56 (Public Water Systems). For the purposes of these Rules, water service lines are potable water supplies.
- (74) **Potable Water Supply Presumptive Isolation Zone** – means an area delineated around a potable water source in which a component of a leachfield with a design

flow of less than 2000 gallons per day is presumed to be unable to be located. It takes the size and shape identified in § 1-1105(a).

- (75) **Primitive Camp** – means a living unit, the occupancy of which neither exceeds 3 consecutive weeks per calendar year nor exceeds a total of 60 days per calendar year, that has no interior plumbing except for one sink with water. Primitive camps may contain a composting or incinerating toilet that does not yield a liquid provided its contents are disposed of in compliance with § 1-929.
- (76) **Professional Engineer** – means an engineer licensed by the Board of Professional Engineering under 26 V.S.A., Chapter 20.
- (77) **Prospective Applicant** – means a person who owns the lot on which is or will be located the building or structure or campground that is or will be served by the wastewater system and potable water supply for which a permit or permit amendment will be sought in the future.
- (78) **Public Water Source** – means a public water source as defined in the Water Supply Rule.
- (79) **Public Water System** – means a public water system as defined in the Water Supply Rule.
- (80) **Recreational Vehicles** – means motor homes, folding camping trailers, conventional travel trailers, fifth wheel travel trailers, truck campers, van campers, conversion vehicles, park model recreational vehicle, and other similar vehicles designed for travel and camping.
- (81) **Replacement Area** – means a portion of land that can accommodate a wastewater system.
- (82) **Replacement System** – means a wastewater system that is proposed to replace a failed system, to replace an operating wastewater system, or to replace a wastewater system proposed in an application when included in lieu of a replacement area in the same application as the wastewater system it would replace, provided that, in none of these scenarios, there is a request or need for an increase in design flow from the wastewater system it would replace. An application involving a request or need for an increase in design flow shall not be construed as seeking approval for a replacement system.
- (83) **Replacement Supply** – means a potable water system that is proposed to replace a failed supply or to replace an operating potable water supply, provided that, in neither of these scenarios, there is a request or need for an increase in design flow from the potable water supply it would replace. An application involving a request or need for an increase in design flow shall not be construed as seeking approval for a replacement supply.

- (84) **Sanitary Sewer Collection Line** – means piping and associated components that collects wastewater from two or more sanitary sewer service lines and conveys it to a wastewater treatment facility, to an indirect discharge system, or to the leachfield of a soil-based wastewater system of less than 6500 gallons per day. A sanitary sewer collection line begins, and a sanitary sewer service line ends, at the joint where multiple sanitary sewer service lines converge.
- (85) **Sanitary Sewer Service Line** – means piping and associated components that conveys wastewater from a building or structure or campground to a wastewater treatment facility, to an indirect discharge system, or to the leachfield of a soil-based wastewater system of less than 6500 gallons per day. Sanitary sewer service lines also include piping that conveys wastewater from a building or structure or campground to a sanitary sewer collection line.
- (86) **Seasonal** – in reference to the use of a single-family residence, means occupancy of the residence for less than 180 days in each calendar year; as used elsewhere in these Rules means of, relating to, or characteristic of a particular season of the year.
- (87) **Seasonal High-Water Table** – means the highest elevation that the water table reaches as determined by soil examination pursuant to § 1-910(g) or determined by monitoring the water table pursuant to § 1-905.
- (88) **Secretary** – means the Secretary of the Agency or a duly authorized representative of the Secretary. A duly authorized representative of the Secretary includes a municipality that has received delegation to implement provisions of these Rules in lieu of the Secretary pursuant to Subchapter 6.
- (89) **Septic Tank Effluent** – means wastewater that discharges from a septic tank.
- (90) **Sewage Officer** – means a person appointed or employed by a municipality to administer these Rules when the municipality has received delegation to implement provisions of these Rules pursuant to Subchapter 6.
- (91) **Single-family Residence** – means a building or a structure that contains only one living unit.
- (92) **Sleeping Space** – means a space that is designed or designated to sleep one person. For example, a single or twin bed equals one sleeping space, and a double bed equals two sleeping spaces.
- (93) **Soil-Based Wastewater System** – means a wastewater system that depends on naturally occurring soil to absorb the effluent from the system and to transmit the wastewater away from the site without any overland flow.
- (94) **Stream** – means the full length and width, including the bed and banks, of any watercourse, including rivers, streams, creeks, brooks, and branches, which experience intermittent or perennial flow. “Stream” does not include ditches or

other constructed channels primarily associated with land drainage or water conveyance through or around private or public infrastructure.

- (95) **Subdivide** – means to divide land by sale, gift, lease, mortgage foreclosure, court-ordered partition or decree, or filing of a plat, plan, or deed in the town records where the act of division creates one or more lots. Subdivision shall be deemed to have occurred on the conveyance of the first lot or the filing of a plat, plan, or deed in the town records, whichever first occurs. A subdivision of land shall also be deemed to have taken place when a lot is divided by a state or municipal highway, road or right-of-way or when a lot is divided by surface waters with a drainage area of greater than ten square miles. A municipal boundary does not create a subdivision. A mortgage deed does not create a subdivision unless a foreclosure occurs that results in the division of land. A lease will not be considered a subdivision unless the lease is effectuated by filing of plat, plan, lease agreement, or deed in the town records.
- (96) **Substantially Completed** – means a building or structure, potable water supply, or wastewater system that is sufficiently constructed for it to be used for its intended purpose.
- (97) **Subsurface Drip Distribution** – means a pressurized wastewater distribution system that delivers small, precise doses of effluent through small diameter, flexible polyethylene tubing (i.e., drip line) with small in-line emitters (orifices that can discharge effluent at slow, controlled rates, usually specified in gallons per hour).
- (98) **Surface Water** – means all streams, reservoirs, ponds, lakes, springs and all bodies of surface waters, artificial or natural, which are contained within, flow through, or border upon the State or any portion of it.
- (99) **Trench** – means a leachfield that is a shallow excavation in the ground, or mound fill material, 48 inches or less in width that is lined with leachfield stone, contains chambers, or utilizes other dispersal method, and that releases wastewater into the soil through perforated distribution pipes.
- (100) **Unconfined Surficial Aquifer** – means an aquifer that is not in bedrock and is not a confined surficial aquifer. An unconfined surficial aquifer is also known as a water table aquifer.
- (101) **Unimproved Lot** – means a lot that is not an improved lot.
- (102) **Wastewater** – means sanitary waste or used water from any building or structure or campground, including, but not limited to, carriage water, toilet water, shower and wash water, food processing wastewater, and process wastewater. Wastewater does not include stormwater.
- (103) **Wastewater System Presumptive Isolation Zone** – means an area delineated around leachfields, replacement areas, and wastewater tanks in which a potable

water source with a design rate of less than or equal to 2.0 gallons per minute, assuming it would be located in bedrock or confined surficial aquifer, is presumed to be unable to be located. It takes the size and shape identified in § 1-913(a).

- (104) **Wastewater System** – means any piping, pumping, treatment, or disposal system used for the conveyance and treatment of sanitary waste or used water (i.e., wastewater), including, but not limited to, carriage water, shower and wash water, and process wastewater. This definition does not include any internal piping or plumbing except for mechanical systems such as pump stations and storage tanks or toilets that are located inside a building or structure and that are integral to the operation of a wastewater system. This definition also does not include wastewater systems that are used exclusively for the treatment and disposal of animal manure. For the purposes of these Rules, “wastewater system” is limited to soil-based wastewater systems of less than 6500 gallons per day, sanitary sewer service lines, and sanitary sewer collection lines. Sanitary sewer service lines and sanitary sewer collection lines may be permitted as part of a soil-based wastewater system.
- (105) **Wastewater Treatment Facility** – means a pollution abatement facility issued a NPDES or federal pretreatment permit pursuant to 10 V.S.A. § 1263 or § 1265 that is not an indirect discharge system or a discharge to an injection well.
- (106) **Water Main** – means water piping, such as a transmission main or distribution main, that is part of a public water system as defined in the Water Supply Rule. This includes piping leading to fire hydrants.
- (107) **Water Service Line** – means the piping that is not a water main and extends from the water main to a building or structure or campground.
- (108) **Water Service Pipe** – means the piping that extends from a potable water source to a building or structure, campground, or water outlet (such as drinking fountains and hose bibbs).
- (109) **Year-round** – in reference to the year-round use of a residence, means occupancy that is equal to or more than 180 days in a calendar year.

Subchapter 3 – Wastewater System and Potable Water Supply Permits

§ 1-301 Permit Required

- (a) Except as provided in this Section and in § 1-302, § 1-303, and § 1-304, no person shall take or cause to be taken any of the following actions without first obtaining a permit or permit amendment from the Secretary for the construction and operation of a potable water supply and wastewater system:
- (1) the subdivision of a lot or lots;
 - (2) the construction of a new potable water supply or wastewater system;
 - (3) the physical modification or replacement of an existing potable water supply or wastewater system;
 - (4) the construction of a new building or structure, including when reconstruction or replacement;
 - (5) the connection of an existing potable water supply or wastewater system to a building or structure;
 - (6) the modification of an existing building or structure in a manner that increases the design flow of any component of the potable water supply or wastewater system or modifies other operational requirements of a potable water supply or wastewater system;
 - (7) the change in use of a building or structure in a manner that increases the design flow of any component of the potable water supply or wastewater system or modifies other operational requirements of a potable water supply or wastewater system;
 - (8) the conversion of an existing public water system to a potable water supply;
 - (9) the conversion of an indirect discharge system to a wastewater system;
 - (10) the creation of a campground;
 - (11) the modification of a campground, including the creation, modification or relocation of one or more individual campsites, in a manner that increases the design flow of any component of the potable water supply or wastewater system or modifies other operational requirements of a potable water supply or wastewater system;
 - (12) the use or operation of a failed supply or failed system; or
 - (13) the commencement of construction of any of the above. For the purposes of this Section, the “commencement of construction” means any work involving the physical construction or modification of a building or structure and its associated potable water supply or wastewater system, for example, foundation excavation, foundation construction, and site work that involves or may affect any portion of the existing or proposed potable water supply or wastewater system.
- (b) When an application proposes to utilize all of, or a portion of, an existing potable water supply or wastewater system and does not involve an increase in design flow of any component of the potable water supply or wastewater system or involve a modification of other operational requirements of the potable water supply or wastewater system, the Secretary may issue a permit or permit amendment authorizing the use of the existing portions of the potable water supply and wastewater system even if those portions are not in full compliance with the technical standards in Chapters 8, 9, 10, 11, and 12, provided:
- (1) The existing portions of the potable water supply and wastewater system are:

- (A) exempt from the permitting requirements of this Subchapter under § 1-303; or
 - (B) if the application proposes only the subdivision of an improved lot and no other activities requiring a permit, permitted and in compliance with the permit.
- (2) A designer certifies that the existing portions of the potable water supply are not a failed supply and the existing portions of the wastewater system are not a failed system.
 - (3) The existing portions of the potable water supply and wastewater system comply with the horizontal isolation distances required pursuant to § 1-912 and § 1-1104 for distances to new portions of the building or structure or campground that:
 - (A) will be constructed outside of the footprint of the existing or replaced building or structure or campground; and
 - (B) will be served by the wastewater system and potable water supply.
 - (4) The existing portions of the potable water supply and wastewater system are connected to a building or structure or campground or were disconnected not more than 4 years prior to the application to utilize the existing supply or system.
 - (5) The new portions of the potable water supply and wastewater system proposed in the application comply with the technical standards in Chapters 8, 9, 10, 11, and 12 of these Rules.
 - (6) If the application involves the subdivision of land:
 - (A) a replacement area, or a replacement system proposed in lieu of a replacement area, is designated for the resulting complete wastewater system, and other existing wastewater systems on the subdivided lot, unless the conditions of § 1-902(b) are met; and
 - (B) the existing portions of the potable water supply and wastewater system comply with the horizontal isolation distances required pursuant to § 1-912 and § 1-1104 for distances to new property lines.
- (c) A person may seek a permit pursuant to Subsection (a)(3) despite not intending to immediately construct the replacement system.
 - (d) The use or operation of a failed supply or failed system is prohibited except in the following situations:
 - (1) The Secretary authorizes the continued use of the failed system or failed supply while the landowner is actively pursuing the cause of, and resolution to, correcting the failed system or failed supply.
 - (2) For a failed supply, a water treatment system is installed in compliance with § 1-1113 that achieves an elimination or reduction in the concentration of primary contaminants in the potable water source to below the standard in Table 11-5.
 - (3) For a failed supply, the potable water supply serves only one single-family residence.
 - (e) Neither soil-based wastewater systems nor sanitary sewer service lines that convey wastewater to indirect discharge systems shall be permitted for the treatment and disposal of any of the following wastewater or wastes:

- (1) Wastewater or waste prohibited from discharge to an injection well pursuant to the prohibition in the Underground Injection Control Regulations against Class I, II, and III, and all but a limited number of Class IV, injection wells.
 - (2) Wastewater or waste prohibited from discharge to a Class V injection well pursuant to the Underground Injection Control Regulations.
 - (3) Wastewater or waste requiring an UIC permit from the Secretary prior to their discharge to a Class V injection well pursuant to the Underground Injection Control Regulations.
 - (4) Any wastewater or waste determined by the Secretary to adversely affect the biological action within a septic tank or leachfield which will not receive pretreatment prior to discharge to the septic tank or leachfield to prevent adverse effects. The Secretary, in making this determination, shall consider pH, dissolved oxygen, alkalinity, temperature, and chemical constituents of the wastewater or waste.
- (f) For the purpose of determining, pursuant to Subsection (a), whether an action will result in an increase in design flow of any component of a wastewater system or potable water supply, the proposed design flow shall be calculated pursuant to § 1-803 and the baseline design flow from which a potential increase is measured shall be calculated pursuant to § 1-806.
- (g) The following actions are presumed to not increase the design flow of any component of the potable water supply or wastewater system or modify other operational requirements of a potable water supply or wastewater system:
- (1) The addition of a home occupation to a living unit.
 - (2) The construction of a new building or structure used solely for a home occupation conducted by the occupants of a living unit that is located on the same lot.
 - (3) The addition of plumbing fixtures in a single-family residence.
 - (4) The addition of a water storage tank for a single-family residence that is served by a potable water source that serves no other buildings or structures and no campground.
 - (5) The addition of one or more bedrooms to a single-family residence with 3 or more bedrooms, that is served by a water service line that serves no other buildings or structures, or campgrounds, and that is served by a sanitary sewer service line that serves no other buildings or structures, or campgrounds, that discharges to a municipal sanitary sewer collection line that conveys wastewater to a wastewater treatment facility.
 - (6) The installation of a composting toilet or incinerator toilet to a single-family residence.

§ 1-302 Permit Exemption for Reconstruction

- (a) A building or structure that is exempt from the permitting requirements of this Subchapter under § 1-303, or that has an associated potable water supply or wastewater system which was permitted by the Secretary on or after January 1, 2007, that has been voluntarily removed or destroyed by fire, flooding, or other force majeure may be reconstructed without obtaining a permit or permit amendment provided all of the following are met:

- (1) The replacement building or structure is in compliance with all conditions of permits issued under these Rules on or after January 1, 2007.
 - (2) If the building or structure is exempt pursuant to § 1-303, it shall be reconstructed within 4 years of its removal or destruction. On a case by case basis, this period may be extended for 1 year by the Secretary if:
 - (A) the request for the extension is submitted in writing before the end of the 4-year period; and
 - (B) the Secretary determines there is good cause for the extension, such as delays in reconstruction due to difficulties resolving insurance claims, insufficient financing, or unresolved municipal permitting issues.
 - (3) The replacement building or structure connects to the existing water service line or water service pipe and existing sanitary sewer service line that were connected to the previously existing building or structure.
 - (4) The replacement building or structure does not increase design flow or modify other operational requirements of the existing potable water supply or wastewater system.
 - (5) The entire footprint of the replacement building or structure, except for that portion of a building or structure that is a deck or porch, is constructed within 50 feet of any outside wall of the previously existing building or structure that is being replaced.
 - (6) No other actions are taken or caused to be taken that under these Rules requires the issuance of a permit or permit amendment.
- (b) For the purposes of this Section, a building or structure is “destroyed” if the building or structure is in ruins, the roof has collapsed, the walls or foundation have collapsed or are collapsing, or the building or structure is condemned by a municipality or the State.

Note: Appendix C, Figure C-1, depicts an example for calculating the 50 feet from an outside wall for reconstruction.

§ 1-303 “Clean Slate” Permit Exemption

- (a) The following are exempt from the permitting requirements of this Subchapter:
 - (1) All buildings or structures, campgrounds, and their associated potable water supplies and waste water systems that were substantially completed before January 1, 2007 and all improved and unimproved lots that were in existence before January 1, 2007. This exemption shall remain in effect provided:
 - (A) No action for which a permit is required under these Rules is taken or caused to be taken on or after January 1, 2007, unless such action is exempt under one of the other permitting exemptions listed in § 1-302 or § 1-304.
 - (B) If a permit has been issued under these Rules before January 1, 2007 that contained conditions that required actions to be taken on or after January 1, 2007, including conditions concerning operation and maintenance and transfer of ownership, the permittee shall continue to comply with those permit conditions.
 - (2) An owner of a single-family residence that qualified on January 1, 2007 for this exemption shall not be subject to administrative or civil penalties under 10 V.S.A.

chapters 201 and 211 for a violation of these Rules when the owner believes the supply or system meets the definition of a failed water supply or failed system provided the owner:

- (A) conducts or contracts for an inspection of the supply or system;
 - (B) notifies the Secretary of the results of the inspection; and
 - (C) has not taken or caused to be taken any other action on or after January 1, 2007 for which a permit would be required under these Rules.
- (3) A holding and pump out tank for food processing waste installed on or prior to July 1, 2020 pursuant to an Indirect Discharge Permit or authorized by the Vermont Agency of Agriculture provided no action requiring a permit is taken on or after July 1, 2020.
- (b) The use of a single-family residence served by a wastewater system or potable water supply for which the exemption in Subsection (a) is in effect shall be considered year-round unless the single-family residence was occupied for fewer than 180 days in each calendar year between and including December 31, 1986 and December 31, 2006.

§ 1-304 Permit Exemptions

The following actions are exempt from the permitting requirements of this Subchapter, provided no other action is taken or caused to be taken that under these Rules requires the issuance of a permit or permit amendment:

- (1) The modification, completed between January 1, 2007 and July 1, 2007, of an existing single-family residence.
- (2) The construction, substantially completed between January 1, 2007 and July 1, 2007, of a single-family residence and its associated potable water supply or wastewater system, provided:
 - (A) the only building or structure on the lot is the single-family residence;
 - (B) the potable water supply and wastewater system complies with the technical standards in Subchapters 8, 9, 10, 11, and 12, except for the requirement to identify a replacement area;
 - (C) a designer completes a design certification for the potable water supply or wastewater system that complies with § 1-306;
 - (D) a designer or, when allowed by these Rules, an installer completes an installation certification for the potable water supply or wastewater system that complies with § 1-311; and
 - (E) copies of the design and installation certifications required pursuant to Subsections (C) and (D) are submitted to the Secretary and recorded and indexed in the land records for the municipality where the building or structure, and, if different, where the wastewater system and potable water supply is located.
- (3) The construction of a primitive camp, provided:
 - (A) the primitive camp is on a lot with no other buildings or structures and with no campground; or

- (B) the primitive camp is on a lot with a single-family residence but no other buildings or structures and no campground.
- (4) The subdivision of an unimproved lot on or after January 1, 2007, provided:
- (A) the deed, that is recorded and indexed, that describes the affected property contains the following language:
“Notice of permit requirements. In order to comply with applicable state Rules concerning potable water supplies and wastewater systems, a person shall not construct or erect any structure or building on the lot of land described in this deed if the use or useful occupancy of that structure or building will require the installation of or connection to a potable water supply or wastewater system, without first complying with the applicable rules and obtaining any required permit. Any person who owns this property acknowledges that this lot may not be able to meet state standards for a potable water supply or wastewater system and therefore this lot may not be able to be improved.”; or
 - (B) if there is no deed for the lot that is created by the act of subdivision, the owner of the unimproved lot shall record and index a copy of the notice language described in Subsection (4)(A) in the land records for the municipality where the unimproved lot is located.
- (5) The addition of land to a lot.
- (6) The subdivision of an improved lot by a lease for the sole purpose to develop a cell tower, solar panel, wind turbine, or telephone switching station provided:
- (A) the horizontal isolation distance between the footprint of the cell tower, solar panel, wind turbine, or telephone switching station and any wastewater system or potable supply shall be a minimum of 10 feet, unless there is a foundation drain, in which case the horizontal isolation distance shall be 20 feet between the wastewater system and upslope drains and 75 feet between the wastewater system and downslope drains;
 - (B) a plan, drawn to scale, and prepared by a designer or land surveyor, of the subdivided lot is prepared showing the location of the existing building or structure and the existing and proposed boundary lines of the subdivided lot;
 - (C) the plan is recorded and indexed in the land records of the municipality where the lot is located within 30 days of the date of the subdivision; and
 - (D) upon termination of the lease, the land subject to the lease reverts to the original lot.
- (7) The subdivision of an improved lot, provided:
- (A) the lot is improved with either:
 - (i) up to two single-family residences or one duplex; or
 - (ii) up to two buildings or structures, two campgrounds, or one building or structure and one campground, where the total design flow for the uses is 560 gallons per day or less;
 - (B) if the buildings or structures or campgrounds are served by soil-based wastewater systems, the new lot boundary for any resulting improved lot

- is 500 feet or more from the footprint of each building or structure and campground;
- (C) a plan, drawn to scale and prepared by a designer or land surveyor, of the subdivided lot is prepared, showing the location of the building or structure and the existing and proposed boundary lines of the subdivided lot; and
 - (D) the plan is recorded and indexed in the land records of the municipality where the lot is located.
- (8) The subdivision of a lot where the subdivision results from a transfer of property for a highway or other transportation project that is authorized under the State's enacted Transportation Program or is an emergency project within the meaning of 19 V.S.A. § 10g(h) regardless of whether the State or the municipality has commenced any condemnation proceedings in connection with the project.
- (9) The boundary line adjustment of improved or unimproved lots, provided:
- (A) each lot being adjusted meets one or more of the following standards:
 - (i) the lot is reduced in size by no more than 2 percent;
 - (ii) the lot is increased in size;
 - (iii) the boundary, after adjustment, is 500 feet or more from the footprint of each building or structure or campground on an improved lot; or
 - (iv) the Secretary makes a written determination that the proposed adjustment will not have an adverse effect on any existing potable water supply or wastewater system on the affected lots. In making the determination, the Secretary shall consider:
 - (I) whether the land being removed from a lot is more suitable for a replacement wastewater system than the land being retained with the lot or land being added to the lot; and
 - (II) whether there is a natural land feature, such as bedrock, that prevents a lot that is being reduced in size from accessing the land being conveyed for a wastewater system;
 - (B) a plan, drawn to scale and prepared by a designer or land surveyor, of the boundary line adjustment is prepared; and
 - (C) the plan and, if applicable, the Secretary's written determination, is recorded and indexed in the land records of the municipality where the lots are located.
- (10) The minor repair or minor replacement of a potable water supply or wastewater system.
- (11) The construction of a municipal sanitary sewer collection line, the connection of a building or structure to the collection line via a new sanitary sewer service line, and the construction of the service line, at the time of initial construction and operation of the municipal sanitary sewer collection line, provided:
- (A) the sanitary sewer collection line and associated sanitary sewer service lines are included on the plans approved by the Water Investment Division of the Department;

- (B) the sanitary sewer service lines comply with the technical standards in Subchapters 8, 9, and 10;
 - (C) a designer completes a design certification for the sanitary sewer service lines that complies with § 1-306;
 - (D) a designer or, when allowed by these Rules, an installer, completes an installation certification for the sanitary sewer service lines that complies with § 1-311; and
 - (E) copies of the design and installation certifications required pursuant to Subsection (C) and (D) are submitted to the Secretary and recorded and indexed in the land records of the municipality where the building or structure is located.
- (12) The connection of an existing building or structure to a water main via a new water service line, and the construction of the water service line, at the time of initial construction and operation of the portion of the municipal water main to which the water service line connects, provided:
- (A) the associated water service lines are included on the plans that are approved as part of a public water system construction permit;
 - (B) the water service line complies with the technical standards in Subchapters 8, 11, and 12;
 - (C) a designer completes a design certification for the water service line that complies with § 1-306;
 - (D) a designer or, when allowed by these Rules, an installer, completes an installation certification for the potable water supply that complies with § 1-311; and
 - (E) copies of the design and installation certifications required pursuant to Subsection (C) and (D) are submitted to the Secretary and recorded and indexed in the land records of the municipality where the building or structure is located.
- (13) The construction of a sanitary sewer service line that connects to an existing municipal sanitary sewer collection line:
- (A) the sanitary sewer service line is included on the plans approved by the Water Investment Division of the Department;
 - (B) the sanitary sewer service line complies with the technical standards in Subchapters 8, 9, and 10;
 - (C) a designer completes a design certification for the sanitary sewer service line that complies with § 1-306;
 - (D) a designer or, when allowed by these Rules, an installer, completes an installation certification for the sanitary sewer service line that complies with § 1-311; and
 - (E) copies of the design and installation certifications required pursuant to Subsection (C) and (D) are submitted to the Secretary and recorded and indexed in the land records of the municipality where the building or structure is located.
- (14) The construction of a water service line that connects to an existing municipal water main:

- (A) the water service line is included on the plans approved by the Water Investment Division of the Department;
 - (B) the water service line complies with the technical standards in Subchapters 8, 11, and 12;
 - (C) a designer completes a design certification for the water service line that complies with § 1-306;
 - (D) a designer or, when allowed by these Rules, an installer, completes an installation certification for the water service line that complies with § 1-311; and
 - (E) copies of the design and installation certifications required pursuant to Subsection (C) and (D) are submitted to the Secretary and recorded and indexed in the land records of the municipality where the building or structure is located.
- (15) The modification of an existing building or structure, the change in use of a building or structure, or the modification of a campground, in a manner that increases the design flow of any component of a sanitary sewer service line, and any associated sanitary sewer collection line, that conveys wastewater to a wastewater treatment facility, provided:
- (A) the building or structure or campground is served by a water service line that connects to a public water system;
 - (B) the modification or change in use does not modify operational requirements that need to be applied to the building or structure or campground, the sanitary sewer service line, and any associated sanitary sewer collection line;
 - (C) a designer certifies that the design capacity of the existing sanitary sewer service line and sanitary sewer collection line can accommodate the increase in design flow or modification of operational requirements;
 - (D) the landowner obtains a letter from the wastewater treatment facility confirming the facility has capacity to treat the constituents of the wastewater and dispose of the design flow identified in § 1-803 for each building or structure or campground to be served by the sanitary sewer service line and any associated sanitary sewer collection line; and
 - (E) a copy of the certification required pursuant to Subsection (13)(B) is recorded and indexed in the land records for the municipality where the building or structure or campground is located.
- (16) The modification of an existing building or structure, the change in use of a building or structure, or the modification of a campground, in a manner that increases the design flow of any component of a water service line, provided:
- (A) the building or structure or campground is served by a sanitary sewer service line, and any associated sanitary sewer collection line, that conveys wastewater to a wastewater treatment facility;
 - (B) the modification or change in use does not modify operational requirements that need to be applied to the building or structure or campground, and water service line;
 - (C) no booster pump is added to the potable water supply;

- (D) a designer certifies that the design capacity of the existing water service line can accommodate the increase in design flow or modification of operational requirements;
 - (E) the landowner obtains a letter from the public water system confirming the public water system has the capability to supply the design flow identified in § 1-803 for each building or structure or campground to be served by the water service line; and
 - (F) a copy of the certification required pursuant to Subsection (14)(C) is recorded and indexed in the land records for the municipality where the building or structure or campground is located.
- (17) The construction of a replacement supply serving only one single-family residence on a lot with no other buildings or structures and with no campground, provided:
- (A) the replacement potable water source will not be located in an area classified by the Secretary as a Class IV groundwater area;
 - (B) the replacement supply does not utilize surface water as the potable water source;
 - (C) there is not a change in use of the single-family residence to also be a child care facility;
 - (D) if the replacement supply is a water service line and a booster pump will be installed in the single-family residence, the technical standards for the booster pump design in § 1-1111(d) are met (Secretary approval for the installation of the booster pump is not required);
 - (E) a form provided by the Secretary that corresponds to the type of replacement supply is recorded and indexed in the land records of the municipality where the single-family residence is located, and, if different, where the replacement supply will be located; and
 - (F) water sampling that complies with § 1-1113(b) and (c) is conducted prior to any consumptive use of the water from the replacement supply.
- (18) The development of a potable water source to supplement an existing potable water source serving only one single-family residence on a lot with no other buildings or structures and with no campground, provided:
- (A) the supplemental potable water source will not be located in an area classified by the Secretary as a Class IV groundwater area;
 - (B) the supplemental potable water source is not a surface water source;
 - (C) there is not a change in use of the single-family residence to also be a child care facility;
 - (D) the potable water supply presumptive isolation zone for the supplemental potable water source does not extend onto land owned by a person different than the owner of the single-family residence;
 - (E) a plan, with contours, drawn to scale prepared by a designer, showing the location of the existing and supplemental potable water sources, the location of the potable water supply presumptive isolation zone for the supplemental potable water source, and the boundary lines for the lot on which the single-family residence is located;

- (F) a form provided by the Secretary, which includes the plan, is recorded and indexed in the land records of the municipality where the single-family residence is located, and, if different, the existing and supplemental potable water sources will be located; and
 - (G) water sampling that complies with § 1-1113(b) and (c) is conducted prior to any consumptive use of the water from the additional potable water supply.
- (19) The deepening of an existing potable water source, provided that water sampling that complies with § 1-1113(b) and (c) is conducted prior to any consumptive use of the water from the deepened potable water source.
 - (20) The use or operation of a failed supply or failed system that is identified in § 1-301(d).
 - (21) The installation and use of a water treatment system for a potable water supply where the treatment system is designed to:
 - (A) reduce or eliminate water hardness;
 - (B) reduce or eliminate properties or constituents on the list of secondary standards in the Vermont Water Supply Rule;
 - (C) reduce or eliminate arsenic, fluoride, lead, manganese, nitrate, nitrite, gross alpha, uranium, or a combination of these, provided the treatment system treats all of the water used for drinking and the preparation of food; or
 - (D) eliminate bacteria, pathogenic organisms, radon, or radium, provided the treatment system treats all of the water used for drinking, washing, bathing, the preparation of food, and laundering.
 - (22) The installation and use of a water treatment system when authorized by the Secretary in a corrective action plan required pursuant to 10 V.S.A. § 6615b, in a remediation plan required pursuant to the Groundwater Protection Rule and Strategy, or in any other response action required to address contamination or the threat of contamination of a potable water supply.
 - (23) The increase in flow to a wastewater system through the connection to the wastewater system of a water treatment system identified in Subsection (19) or in Subsection (20).
 - (24) The increase in flow to an existing wastewater system as a result of the use of a water treatment system identified in Subsection (19) or in Subsection (20).
 - (25) The change in use of a single-family residence, on a lot with no other buildings or structures and with no campground, to include a family child care home registered by the Vermont Agency of Human Services, Department for Children and Families, provided the potable water supply does not utilize surface water as the potable water source.

- (26) The installation of a water service pipe from a potable water source serving only one single-family residence, to provide water to an outside hose bibb that is located on the same lot as the residence.
- (27) The construction of a wastewater system for purposes of serving only State or Federally owned remote campsites, provided:
- (A) each campsite is served by a waterless alternative toilet, a composting toilet that does not yield a liquid, or a waterless pit privy that complies with the horizontal isolation distances contained in Table 9-3 without a reduction by the Secretary, except horizontal isolation distances from trees; and
 - (B) if a waterless pit privy is used, the bottom of the excavation for the pit privy maintains a minimum of 36 inches above the seasonal high-water table, a minimum of 36 inches above a soil that has a soil texture of sandy clay, clay, or silty clay, and a minimum of 48 inches above bedrock.

For the purposes of this Subsection, “remote campsites” means campsites regarded as remote campsites by the state or federal agency that makes the campsite available.

- (28) A periodic and temporary change in use of a building or structure for events, provided:
- (A) the building or structure is served by a potable water supply and wastewater system;
 - (B) each event lasts no more than 4 consecutive days;
 - (C) there are no more than 12 days of events per year;
 - (D) the owner of the building or structure retains records of the dates of each event for at least 3 years following each event and provides them to the Secretary if requested by the Secretary.

Examples include the periodic and temporary change in use of a hotel, motel, or restaurant for holding weddings; of an arena for holding horse shows; or of a building or structure for holding auctions, vehicle shows, or periodic concerts, provided the changes in use meets the criteria in this Subsection. The provision of an adequate number of alternative toilets and alternative hand washing supplies to accommodate everyone on site for the event is encouraged.

- (27) The construction and use of a building or structure that will be used for events, provided:
- (A) the building or structure is not connected to a water service line, water service pipe, or sanitary sewer service line;
 - (B) there are no more than 28 days of events per year;
 - (C) there is no food preparation or dishwashing on site for the events unless the food preparation or dish washing is:
 - (i) fully completed within a mobile unit licensed by the Vermont Department of Health as a Temporary Food Stand or motorized or push cart type mobile unit; and
 - (ii) does not require on site water or waste disposal;
 - (D) the events do not require water, including for food preparation, dish washing, or clean-up, other than:

- (i) for hand washing that is accommodated by alternative hand washing supplies; and
 - (ii) the disposal of wastewater that is accommodated by the use of alternative toilets;
 - (E) an adequate number of alternative toilets and alternative hand washing supplies are provided to accommodate everyone on site;
 - (F) there is no discharge of wastewater to the ground surface;
 - (G) the owner of the building or structure retains records of the following actions for at least 3 years following each event and provides them to the Secretary if requested by the Secretary:
 - (i) dates of each event;
 - (ii) the frequency of the pumping of the alternative toilets;
 - (iii) the number of gallons pumped from the alternative toilets; and
 - (iv) the dates on which alternative toilets and alternative hand washing supplies were delivered to the lot and removed from the lot.
- (28) The periodic and temporary creation of a campground provided:
- (A) The campground is not connected to a water service line, water service pipe, or sanitary sewer service line;
 - (B) there are no more than 12 nights of camping per year; and
 - (C) there is no discharge of wastewater to the ground surface.
- (29) The construction and use of a building or structure for seasonal outdoor activities (e.g., outdoor archery, gun range, golf driving range, farm stand, Christmas tree farm), provided:
- (A) the use does not require water for operation or clean-up, including employee wash up, other than for:
 - (i) hand washing that is accommodated by alternative hand washing supplies; and
 - (ii) the disposal of wastewater that is accommodated by the use of alternative toilets; and
 - (iii) the building or structure is not connected to a water service line, water service pipe, or sanitary sewer service line.
- (30) The construction of a building or structure associated with quarries, sand and gravel pits, and rock crushing operations, where site conditions prevent the installation of a soil-based wastewater system, provided:
- (A) a designer submits a written certification to the Secretary stating that based on their site investigations no soil-based wastewater system that complies with these Rules can be located within a 500-foot radius of the building or structure;
 - (B) the use does not require water for operation or clean-up, including employee wash up, other than for:
 - (i) hand washing that is accommodated by alternative hand washing supplies; and
 - (ii) the disposal of wastewater that is accommodated by the use of alternative toilets; and

- (C) the building or structure is not connected to a water service line or water service pipe.
- (31) The placement and use of a mobile home or recreational vehicle at a construction site as temporary office space occupied by employees, provided:
- (A) the mobile home or recreational vehicle is removed immediately upon completion of construction;
 - (B) the use does not require water for operation or clean-up, including employee wash-up, other than for:
 - (i) hand washing that is accommodated by alternative hand washing supplies; and
 - (ii) the disposal of wastewater that is accommodated by the use of alternative toilets; and
 - (C) the mobile home or recreational vehicle is not connected to a water service line, water service pipe, or sanitary sewer service line.
- (32) The use of telephone switching stations, electrical substations, hydroelectric dam operation stations, and similar buildings or structures, for their intended purposes, provided:
- (A) the use involves no more than 4 employees that enter or visit the building or structure for less than 2 hours each in any day;
 - (B) the use does not involve access to the building or structure by non-employees;
 - (C) the use does not require water for operation or clean-up, including employee wash-up; and
 - (D) the building or structure is not connected to a water service line, water service pipe, or sanitary sewer service line.
- (33) The use of rental storage units as rental storage units, provided:
- (A) the use involves no more than 4 employees that enter or visit the building or structure for less than 2 hours each in any day;
 - (B) the use does not require water for operation or clean-up, including employee wash-up; and
 - (C) the building or structure is not connected to a water service line, water service pipe, or sanitary sewer service line.

§ 1-305 Applications for Permits

- (a) Applications for permits or permit amendments required pursuant to § 1-301 shall be:
 - (1) submitted using the application form provided by the Secretary and be completed in accordance with the instructions provided with the application form;
 - (2) contain the information required in this Section and Appendix A and all other information necessary to demonstrate compliance with requirements in these Rules that apply to the application;
 - (3) signed by the person who owns the lot on which is or will be located the building or structure or campground that is or will be served by the wastewater system and potable water supply for which a permit or permit amendment is sought (i.e., the applicant); and

- (4) submitted to the Regional Office that processes applications for the location the application concerns.
- (b) Applications involving a wastewater system, potable water supply, or replacement area that is or will be located on a lot other than the lot where the building or structure or campground served or to be served by the system or supply is located, shall include:
 - (1) documentation that demonstrates the applicant has permanent legal access to the current or proposed off-lot potable water supply, wastewater system, or replacement area for the purposes of construction, operation, and maintenance of, as applicable, a potable water supply or wastewater system; or
 - (2) a signed and dated document from the owner of the lot on which the off-lot potable water supply, wastewater system, or replacement area is or will be located, provided the owner is not the applicant, indicating that:
 - (A) the owner will convey to the applicant permanent legal access to the current or proposed off-lot potable water supply, wastewater system, or replacement area shown on the site plan for the purposes of construction, operation, and maintenance of, as applicable, a potable water supply or wastewater system; and
 - (B) the owner will record and index the documents establishing such permanent legal access in the municipality where the building or structure or campground is or will be located, and, if different, where the wastewater system and potable water supply is or will be located, within 30 days of the date of the permit.
- (c) An application seeking a variance pursuant to § 1-802 shall include a written request for the variance that meets the requirements of § 1-802(d).
- (d) The perimeter of each proposed in-ground leachfield, at-grade leachfield, mound, and bottomless sand filter, and the center of each proposed potable water source, except when the potable water supply utilizes a surface water source, shall be flagged in the field prior to filing an application and the flagging maintained by the landowner until the Secretary issues a permit or denial, or the landowner withdraws the application from consideration.
- (e) An application for the construction and operation of only a wastewater system or only a potable water supply needs a site plan, detail sheets, and any accompanying narrative and supporting data and design certification for only the system or the supply that is to be permitted.
- (f) The Secretary may waive the submission, otherwise identified in Appendix A, of detail sheets for existing components of a wastewater system or potable water supply included in an application that the application does not propose to change.
- (g) An application for a sanitary sewer service line, and any associated sanitary sewer collection line, that conveys wastewater to a wastewater treatment facility or an indirect discharge system, shall include a letter from the wastewater treatment facility or indirect discharge system confirming the facility or system has capacity to treat the constituents of the wastewater and dispose of the design flow identified in § 1-803 for each building

or structure or campground to be served by the sanitary sewer service line and any associated sanitary sewer collection line.

- (h) An application for a water service line shall include a letter from the public water system confirming the public water system has the capability to supply the design flow identified in § 1-803 for each building or structure or campground to be served by the water service line.
- (i) An application to use surface water as the potable water source serving one single-family residence shall include the following statement signed by the applicant:
“I understand that a surface water source may not provide the same water quality as a groundwater source and that a surface water source will require constant treatment of the water including monitoring, proper operation, and maintenance of the water treatment system. I understand that the use of a treatment system will not ensure the water will meet drinking water standards. I understand I may not be notified when chemicals, such as lampricide, are applied to the surface water that serves my residence. I understand and accept the potential risk to human health and the liability for use of the surface water source and treatment system to provide potable water to my residence.”
- (j) The Secretary shall not commence a technical review of a permit application under these Rules until he or she deems the application is administratively complete, meaning the application includes a complete application form; application fee; connection approval letters, when required by Subsections (g) or (h); signed statement concerning a surface water source, when required by Subsection (i); documentation of permanent legal access, when required by Subsection (b); and a site plan and detail sheets, when required for the wastewater system or potable water supply for which the permit or permit amendment is required.
- (k) An applicant may withdraw an application without prejudice at any time until the Secretary renders a decision on the project. The application fee will be refunded only when the request for withdrawal of the application is made prior to the initiation of a technical review.
- (l) The Secretary shall give deference to a design certification included in an application, with respect to engineering design or judgment exercised by the designer, for the following aspects of the design:
 - (1) calculations used to size grease interceptors;
 - (2) calculations used to size septic tanks;
 - (3) calculations used to determine dosing volumes and pressure distribution;
 - (4) calculations used to determine cleansing velocities of sanitary sewer collection lines;
 - (5) slopes of sanitary sewer service lines or sanitary sewer collection lines;
 - (6) calculations for sizing wastewater and water pumps and pump selections;
 - (7) calculations for sizing water service lines, water service pipes, and sanitary sewer service lines;
 - (8) calculations for sizing water storage; and
 - (9) specifications for quality of workmanship.

- (m) Nothing in Subsection (l) shall limit the responsibility of the designer to comply with these Rules with respect to the design of, and design certification for, a wastewater system or potable water supply.
- (n) Nothing in Subsection (l) shall limit the authority of the Secretary to review and comment on design aspects of an application or to enforce these Rules with respect to the design or the design certification. The Secretary retains the authority to deny an application that includes a design that is out of compliance with these Rules.

§ 1-306 Site Plans, Supporting Information, and Design Certification

- (a) All site plans, detail sheets, accompanying narrative, and other supporting data for the design of a wastewater system or potable water supply submitted with a permit application shall be prepared, signed and dated by a designer.
- (b) All site plans, detail sheets, accompanying narrative, and other supporting data for the design of a wastewater system or potable water supply that is required in a permit application shall be accompanied by a design certification, signed and dated by a designer, that states:
“I hereby certify that, in the exercise of my reasonable professional judgment, the design-related information submitted with this application is true and correct and the design included in this application for a permit complies with the Vermont Wastewater System and Potable Water Supply Rules.”

§ 1-307 Required Notification of Presumptive Isolation Zones

- (a) When an applicant for a permit or permit amendment proposes a potable water supply or wastewater system with a wastewater system presumptive isolation zone or potable water supply presumptive isolation zone that extends onto property other than the property for which the permit is sought, the permit applicant shall send by certified mail, on a form provided by the Secretary, a notice of an intent to file a permit application, with the site plan that will be included with the permit application and that accurately depicts the presumptive isolation zone, to any landowner affected by the presumptive isolation zone at least 7 calendar days prior to the date that the permit application is submitted to the Secretary.
- (b) If, during the course of the Secretary’s review of an application for a permit or permit amendment, the location of a wastewater system and potable water supply is revised, and the revised wastewater system presumptive isolation zone or potable water supply presumptive isolation zone extends onto property other than the property for which the permit is sought, the permit applicant shall send by certified mail, on a form provided by the Secretary, a notice of filing a revised site plan, with the revised site plan that accurately depicts the revised presumptive isolation zone, to any landowner affected by the revised presumptive isolation zone.
- (c) If, after a permit or permit amendment has been issued under this Section, a water supply or wastewater system is not installed in accordance with the permit and if the record drawings indicate that the wastewater system presumptive isolation zone or potable water

supply presumptive isolation zone as constructed extends onto property other than the property on which the system is located, the permittee shall send by certified mail a notification form provided by the Secretary with a copy of the record drawings showing the presumptive isolation zone to any landowner affected by the presumptive isolation zone.

- (d) An applicant or permittee subject to the requirements of Subsections (a) through (c) shall submit a copy of the certified mail receipts to the Secretary demonstrating that the notices and information required by this Section have been sent by certified mail to affected landowners and shall include in the certification the name and address of all affected landowners. If the Secretary approves a permit or permit amendment application, the permit shall not be issued to an applicant subject to the requirements of Subsection (b) prior to 7 calendar days after the applicant certifies to the Secretary that the notice required under this Section has been sent to affected landowners.
- (e) Notwithstanding Subsections (a) through (c), the notifications identified in this Section are not required for wastewater system presumptive isolation zones or potable water supply presumptive isolation zones that fall under one of the following descriptions:
 - (1) the presumptive isolation zone extends only onto property owned by the applicant;
 - (2) the presumptive isolation zone extends only onto a Town or State highway;
 - (3) the presumptive isolation zone does not differ in location from that which existed prior to the pending application or record drawings, provided the potable water supply or wastewater system existing prior to the application or record drawings was exempt from the permitting requirements of this Subchapter under § 1-303 or was permitted and in compliance with the permit;
 - (4) the potable water supply presumptive isolation zone is for a replacement supply;
 - (5) the wastewater system presumptive isolation zone is for a replacement system, provided the replacement system is not proposed in lieu of a replacement area in the same application as the wastewater system it would replace;
 - (6) the potable water supply presumptive isolation zone exists only in a municipality that prohibits the installation of a soil-based wastewater system; or
 - (7) the wastewater system presumptive isolation zone exists only in a municipality that prohibits the installation of a potable water supply other than a connection to the municipal water supply.

§ 1-308 Denial of an Application for a Permit

The Secretary shall deny, in writing, an application if the Secretary reaches one of the following conclusions:

- (1) the owner of a wastewater treatment facility, indirect discharge system, or public water system has approved the physical connection of a sanitary sewer service line, sanitary sewer connection line, or water service line to the wastewater treatment facility, indirect discharge system, or water main when the Secretary has prohibited the allocation of additional capacity from the facility or system;
- (2) the proposed project does not comply with the technical standards in Subchapters 8, 9, 10, 11, and 12 or is otherwise not able to be developed in compliance with these Rules;

- (3) the information submitted is not sufficient to make a determination that the proposed project can be developed in compliance with these Rules;
- (4) the information submitted is determined to be false or misleading; or
- (5) the application proposes the treatment and disposal of wastewater or wastes identified in § 1-301(e).

§ 1-309 Permit Conditions

- (a) The Secretary may include any condition in a permit that he or she deems necessary to protect human health and the environment or to otherwise satisfy the purposes and requirements of these Rules, including requirements addressing operation and maintenance of a wastewater system or potable water supply.
- (b) A permit for a wastewater system may be conditioned on the completion of a groundwater sampling, effluent sampling, water metering, and water quality sampling program when the Secretary determines a program is necessary to detect potential contamination and degradation of groundwater or surface water.
- (c) A permit that approves a sanitary sewer service line, and any associated sanitary sewer collection line, that conveys wastewater to a wastewater treatment facility or an indirect discharge system, shall be conditioned on the existence, at the time of construction of the permitted wastewater system, of capacity in the wastewater treatment facility or indirect discharge system to treat the constituents of the wastewater and dispose of the design flow identified in § 1-803 for each building or structure or campground to be served by the sanitary sewer service line and any associated sanitary sewer collection line.
- (d) A permit that approves a water service line shall be conditioned on the existence, at the time of construction of the permitted potable water supply, of capability of the public water system to supply the design flow identified in § 1-803 for each building or structure or campground to be served by the water service line.
- (e) A permit that approves a potable water supply with a surface water potable water source shall contain conditions that require the landowner, prior to a change of ownership of the lot on which the building or structure or campground served by the supply is located, to submit the following documents to the Secretary:
 - (1) An inspection report, completed by a professional engineer practicing within the scope of their engineer specialty, that:
 - (A) confirms all approved components of the water treatment system exist and are functioning properly pursuant to the approved design; or
 - (B) if one or more components are not in existence or functioning properly, identifies corrective actions needed to bring the design into compliance with the approved design, and identifies those components that are in existence and functioning properly pursuant to the approved design.
 - (2) Documentation demonstrating that the inspection report was provided to the prospective landowner.
 - (3) If the inspection report required corrective action, a second inspection report completed by a professional engineer, practicing within the scope of their engineering specialty, certifying the corrective actions have been taken and all

approved components of the water treatment system exist and are functioning properly per the approved design.

(4) The following statement signed by the prospective landowner:

“I understand that a surface water source may not provide the same water quality as a groundwater source and that a surface water source will require constant treatment of the water including monitoring, proper operation, and maintenance of the water treatment system. I understand that the use of a treatment system will not ensure the water will meet drinking water standards. I understand I may not be notified when chemicals, such as lampricide, are applied to the surface water that serves my residence. I understand and accept the potential risk to human health and the liability for use of the surface water source and treatment system to provide potable water to my residence.”

(f) A permit that approves a wastewater system that includes a constructed wetland shall contain conditions addressing:

- (1) the operation and maintenance of the constructed wetland that are specific to the particular design and site; and
- (2) reporting requirements to ensure compliance with the operational and maintenance requirements.

§ 1-310 Filing of Permit

- (a) Except where otherwise specified in these Rules, permits issued under these Rules shall run with the land.
- (b) Within 30 days of permit issuance, the permittee shall ensure the permit is recorded and indexed in accordance with the provisions of 24 V.S.A. §§ 1154 and 1161 in the land records of the municipality where the building or structure or campground is or will be located, and, if different, where the wastewater system and potable water supply is or will be located.

§ 1-311 Construction and Installation Certification

- (a) A designer shall flag each of the following prior to construction or site work on the lot on which the wastewater system and potable water source approved in a permit is, or will be, located and the flags shall be maintained by the landowner until commencement of construction of the wastewater system component or potable water source:
 - (1) Perimeter of the approved leachfield, or, if the leachfield is within a bottomless sand filter or a mound, perimeter of the bottomless sand filter or mound.
 - (2) Perimeter of the approved replacement area; and
 - (3) Center of the approved potable water source.
- (b) Subsequent to the substantial completion of a potable water supply or wastewater system and prior to the use and operation of the wastewater system or potable water supply, a signed and dated installation certification from an installer, or a designer if required in Subsection (f), shall be submitted to the Secretary that states:

“I hereby certify that, in the exercise of my reasonable professional judgment, the installation-related information submitted is true and correct and the potable water supply and wastewater system:

- (A) *were installed in accordance with:*
 - (i) *the permitted design and all permit conditions; or*
 - (ii) *record drawings and such record drawings are in compliance with the Vermont Wastewater and Potable Water Supply Rules, were filed with the Secretary, and are in accordance with all other permit conditions;*
 - (B) *were inspected;*
 - (C) *were properly tested; and*
 - (D) *have successfully met those performance tests.”*
- (c) If any deviations to a permitted design for a wastewater system or potable water supply occur during the construction or installation of the system or supply, the permittee shall submit one of the following to the Secretary:
- (1) An application for a permit amendment if, pursuant to Subsection (d), any deviation constitutes a significant modification of the design of the wastewater system or potable water supply that was approved; or
 - (2) Each of the following if no deviation constitutes a significant modification of the design of the wastewater system and potable water supply that was approved:
 - (A) record drawings prepared by a designer for the constructed and installed wastewater system or potable water supply that specify all deviations from the permitted design; and
 - (B) a design certification, signed and dated by the designer, that states:

“I hereby certify that, in the exercise of my reasonable professional judgment, the record drawings are true and correct and the design shown on the record drawing complies with the Vermont Wastewater System and Potable Water Supply Rules.”
- (d) For the purposes of this Section, a significant modification of the design of the wastewater system or potable water supply is one or more of the following:
- (1) 50 percent or more of the leachfield is not located within the footprint of the leachfield as depicted on the approved site plan;
 - (2) portions of the leachfield are in an area for which no soil testing was submitted in the application or for which existing soil testing indicates the soil may not be suitable for the type of leachfield designed;
 - (3) the wastewater system includes a pump station that is not part of the approved design;
 - (4) the location of the leachfield is changed from the location depicted on the approved site plan so that a new or revised hydrogeologic analysis is necessary;
 - (5) the wastewater system is a different type of system from the type that was approved, such as the installation of a mound or at grade system when an in-ground system was permitted;
 - (6) the installation of a different innovative/alternative system or component, or the installation of a different manufacturer’s model of an innovative/alternative system or component, than is part of the approved design;
 - (7) the failure to install an innovative/alternative system or component that is part of the approved design;
 - (8) the design of the sanitary sewer service line is modified so that manholes are required;

- (9) the potable water supply is modified by the addition of water storage or pressure tanks, except for such modifications at a single-family residence served by a potable water supply that serves no other building or structure and no campground;
 - (10) the potable water supply includes a booster pump that is not part of the approved design;
 - (11) the wastewater system or potable water supply includes a modification that creates non-compliance with a technical standard in Subchapters 8, 9, 10, 11, or 12;
 - (12) the wastewater system or potable water supply includes a modification involving an action or design for which these Rules require a Secretary determination;
 - (13) the wastewater system or potable water supply includes a modification that would otherwise require a permit amendment pursuant to § 1-301; or
 - (14) any other modification that the Secretary determines is a significant modification.
- (e) Applications for permit amendments required pursuant to Subsection (c)(1) shall be subject to the same review process as other permit amendment applications.
 - (f) A designer shall submit the installation certification required pursuant to Subsection (b) when any of the following circumstances exist:
 - (1) the installation is completed in accordance with record drawings;
 - (2) the Secretary determines that the proposed wastewater system or potable water supply is of a type, complexity, or size that requires the expertise and knowledge of a specific class of designer and includes as a condition of the permit that a designer of a specified class submit the installation certification; or
 - (3) when otherwise required by these Rules.
 - (g) A permit issued by the Secretary shall be invalid for the use and operation of a substantially completed potable water supply or wastewater system unless and until an installation certification meeting the requirements of Subsection (b) is received by the Secretary.
 - (h) Notwithstanding Subsection (b), an installation certification need not be submitted for a substantially complete potable water supply or wastewater system when the authorizing permit or permit amendment does not contain a condition requiring an installation certification for the potable water supply or wastewater system.

§ 1-312 Authorization to Commence with Site Work or Foundation Construction

- (a) Following submission of an administratively complete application for a permit under this Subchapter, but prior to the issuance of a permit, an applicant may request authorization from the Secretary to commence site work for the proposed wastewater system or potable water supply or site work or foundation construction for a building or structure to be served by the wastewater system or potable water supply.
- (b) Within 30 days of receipt of a request made pursuant to Subsection (a), the Secretary shall grant or deny the request or request additional information from the applicant necessary to make a determination under Subsection (c).

- (c) The Secretary shall grant authorization when the Secretary determines that the soil and other conditions of the site of the proposed leachfield, sanitary sewer service line, sanitary sewer collection line, or potable water source complies with these Rules.
- (d) An authorization may limit the work that may be done prior to issuance of the permit and shall not be construed to mean that the applicant does not have to obtain any other permits prior to engaging in the site work or foundation construction.

§ 1-313 Additional Requirement for Replacement Systems and Replacement Supplies Permitted by Variance

Replacement systems or replacement supplies that are permitted by a variance granted under § 1-802 shall only be connected to buildings or structures or campgrounds that are located on the same lot as the buildings or structures and campgrounds that were served by the system or supply being replaced at the time the variance is granted.

Subchapter 4 – Approval of Innovative/Alternative Systems and Components

§ 1-401 Purpose and Decisions

- (a) This Subchapter authorizes the Secretary to review and approve the following innovative/alternative systems and components for their use and inclusion in designs for wastewater systems:
- (1) alternative materials used in the construction or fabrication of tankage that is part of a wastewater system;
 - (2) a component used for the treatment of wastewater prior to disposal including filter units;
 - (3) a component that is substituted for conventional wastewater distribution systems to a leachfield;
 - (4) a component or alternative method that substitutes for conventional wastewater dispersal in a leachfield; and
 - (5) a new wastewater system design or a new design for a portion of a wastewater system.
- (b) The Secretary may require manufacturers of innovative/alternative systems and components to provide the following information either as part of their applications for approval or as a condition of their approval:
- (1) component manuals;
 - (2) design instructions;
 - (3) installation instructions;
 - (4) required operation and maintenance activities and the frequency at which they must occur;
 - (5) instructions for the owner of the system; and
 - (6) a list of representatives and manufacturer trained and approved designers, installers and service providers.
- (c) All decisions by the Secretary on applications for approval of the use and inclusion of innovative/alternative systems or components shall specify the type of approval granted (general use, pilot, or experimental), be in writing, and include conditions related to the following:
- (1) the obligations of the system or component owner to operate and maintain the system or component;
 - (2) requirements for inspections to be completed and inspections reports be submitted to the Secretary when necessary to confirm the system or component is functioning in a manner that meets the manufacturer's specifications;
 - (3) requirements for the manufacturer of the innovative/alternative system or component to maintain at least two manufacturer trained and approved service providers, when inspections are required to be completed; and
 - (4) prohibiting any change or modification to the design of the innovative/alternative system or component without prior review and approval by the Secretary.
- (d) Denials of requests for approval shall be in writing and state the basis for the denial.

- (e) Approvals may have an expiration date. Manufacturers granted approval may seek renewal of approvals.
- (f) Following expiration or revocation of an approval, a wastewater system and potable water supply permit authorizing installation of the previously approved innovative/alternative systems and components remains valid.
- (g) Notwithstanding any condition in a permit authorizing the use or inclusion of an innovative/alternative system or component which has an approval requiring inspection of that system or component to be completed by a manufacturer-approved designer, the inspection may be completed by:
 - (1) a manufacturer-approved service provider; or
 - (2) if the manufacturer is no longer in business in Vermont:
 - (A) a designer; or
 - (B) a person authorized by the Secretary when that person demonstrates knowledge for properly maintaining and repairing the system or component to operate in a manner that meets the manufacturers requirements.
- (h) The Secretary may revoke an authorization for a system or component when the Secretary determines:
 - (1) the authorization was granted on the basis of incorrect, false, or misleading information;
 - (2) the system or component fails to perform in compliance with any performance standard established for the system;
 - (3) the system or component does not function with the expectations for reliability and protection of health and the environment upon which the authorization was based on; or
 - (4) the company, manufacturer, or vendor fails to comply with conditions in the authorization including conditions concerning:
 - (A) maintaining records of sale or installation of a component;
 - (B) sale of a component when a permit requires the use of a different component;
 - (C) filing required reports;
 - (D) maintaining a required supply of repair or replacement parts; or
 - (E) ensuring an adequate supply of trained individuals to operate and maintain the system or component, if required.

§ 1-402 General Use Approval

- (a) The Secretary shall authorize the general use of an innovative/alternative system or component proposed by a manufacturer seeking approval when the Secretary determines that the manufacturer has demonstrated the following:
 - (1) the design of the innovative/alternative system or component protects human health and the environment;
 - (2) the design of the innovative/alternative system or component satisfies the particular purposes served by the specific technical standards in Subchapters 8, 9, 10, 11, and 12 for which the system or component is intended to substitute; and

- (3) the innovative/alternative system or component is of demonstrated reliability and performance for its proposed use in soil and climate found in Vermont, based on its use elsewhere, such as other States or Canadian Provinces.
- (b) An application for general use approval shall contain documentation demonstrating each of the above determinations, including documentation of bench or field testing of the system or component at a certified laboratory and testing facility by a third party or the manufacturer that meets the requirements of § 1-407.

§ 1-403 Pilot Approval

- (a) The Secretary shall authorize the pilot use of an innovative/alternative system or component proposed by a manufacturer seeking approval when the Secretary determines that the manufacturer has demonstrated the following:
 - (1) the design of the innovative/alternative system or component protects human health and the environment;
 - (2) the design of the innovative/alternative system or component satisfies the particular purposes served by the specific technical standards in Subchapters 8, 9, 10, 11, and 12 for which the system or component is intended to substitute; and
 - (3) the proposal is designed to measure and report data related to reliability and performance of the innovative/alternative system or component in soil and climate found in Vermont.
- (b) An application for pilot approval shall contain documentation demonstrating each of the above determinations, including documentation of bench or field testing of the system or component at a certified laboratory and testing facility by a third party or the manufacturer that meets the requirements of § 1-407.
- (c) Up to 25 installations or uses of each specific innovative/alternative system or component may be authorized in the pilot approval.

§ 1-404 Experimental Approval

- (a) The Secretary may authorize the use of an experimental innovative/alternative system or component intended to try a new technology, application of technology, or methods proposed by a manufacturer seeking approval when the Secretary determines that the manufacturer has demonstrated the following:
 - (1) the design of the innovative/alternative system or component protects human health and the environment; and
 - (2) the design of the innovative/alternative system or component satisfies the particular purposes served by the specific technical standards in Subchapters 8, 9, 10, 11, and 12 for which the system or component is intended to substitute.
- (b) An application for experimental approval shall contain documentation demonstrating each of the above determinations, including, if it exists, documentation of bench or field testing of the system or component at a certified laboratory and testing facility by a third party or the manufacturer that meets the requirements of § 1-407.

- (c) Up to 5 installations or uses of each specific innovative/alternative system or component may be authorized in the experimental approval.
- (d) The Secretary, as a condition of the wastewater system and potable water supply permit authorizing the installation of an experimental innovative/alternative system or component, shall require the owner of the installed system or component to perform monitoring of the system's or component's operation and submit monitoring reports to the Secretary.
 - (1) The type and frequency of monitoring shall be the monitoring necessary to demonstrate that the specific approved system or component is functioning as intended.
 - (2) If the system or component is to treat the wastewater, the condition shall include a requirement to sample the discharge from the system or component and to the submit testing results to demonstrate the system or component is meeting the expected level of treatment.

§ 1-405 Application Process for Innovative/Alternative Systems and Components

An application for approval of the use and inclusion of an innovative/alternative system or component in wastewater system and potable water supply permits shall be submitted on a form prepared by the Secretary. The application form shall require the following information.

- (1) General information:
 - (A) Company, manufacturer, vendor, or designer name.
 - (B) Mailing address of company, manufacturer, vendor, or designer.
 - (C) Administrative contact's name, address, phone number, and e-mail address.
- (2) System or component information:
 - (A) System trade name and model(s)/number(s), if any.
 - (B) Description of theory of operation.
- (3) Statement of claim:
 - (A) Advantages related to prevention of health hazards, surface and groundwater pollution, environmental damage, or other similar advantages from the use of the innovative/alternative system or component.
 - (B) Treatment performance claims, if any, expressed in mg/L or in appropriate units for biological constituents.
 - (C) Type of authorization (general, pilot, or experimental) requested and justification why the system or component belongs in the requested class.
 - (D) Possible causes of or reasons for failure and an assessment of the risks to public health, owners/operators of the system or component, and the environment from such failure.
 - (E) Documentation demonstrating the authorization-type specific determinations included in the proceeding sections that the Secretary must make prior to authorizing use.
- (4) Authorization and denial history:
 - (A) Authorizations from other States or Provinces, including copies of all authorizations, and the contact person for each State or Province.

- (B) Denials from other States or Provinces, including copies of all denials, and the contact person for each State or Province.
- (5) Information related to the system or component:
 - (A) Copies of all operational reports, patent information, technical reports, and laboratory reports on the proposed innovative/alternative system or component, even if the information might in whole or part reflect negatively on the system or component.
 - (B) Documentation of all bench or field testing conducted of the system or component at a certified laboratory and testing facility by a third party or the manufacturer that meets the requirements of § 1-407.
 - (C) The number of systems or components installed and their jurisdictional location.
 - (D) Reports of any component or system that was found to not properly function or operate, or to not meet the manufacturer's performance expectation, with the cause, if determined, and any corrections or modifications to the system or component that were made to correct or prevent future functioning or operational problems or non-compliance with performance expectations.
 - (E) Reports that demonstrate the design of the innovative/alternative system or component satisfies the particular purposes served by the specific technical standards in Subchapters 8, 9, 10, 11, and 12 for which the system or component is intended to substitute.
- (6) Design criteria:
 - (A) Design and material requirements.
 - (B) Plans and cross sections for the innovative/alternative system or component.
 - (C) Design limitations or restriction, including sizing, siting, and wastewater strength and characteristics.
 - (D) Leachfield sizing and justification.
 - (E) Construction requirements and limitations.
 - (F) For systems and components intended for treating of wastewater, the location of sampling ports for samples for analysis of the treated wastewater.
- (7) Operation requirements:
 - (A) Technical qualifications for operators.
 - (B) Specific actions required to operate the system or component.
- (8) Maintenance requirements:
 - (A) Technical qualifications for service providers.
 - (B) Specific actions and their frequency required to maintain the system or component.
 - (C) Information that will be provided to owner of the system or component regarding maintenance requirements.
- (9) Monitoring and analysis requirements:
 - (A) Proposed schedule for monitoring, including frequency and constituents, if any is proposed.
 - (B) The method for collection, delivery, and analyses of the effluent from the system or component that meets the requirements of 40 C.F.R. Part 136, unless an alternative method is approved by the Secretary.

- (C) Results of the effluent analysis performed by:
 - (i) a laboratory certified by the NELAC Institute (TNI) to test for the parameters of concern; or
 - (ii) a laboratory accepted by the Bureau de Normalization du Quebec or the European Committee for Standardization.
- (10) Cost estimates:
 - (A) Retail costs.
 - (B) Construction and installation costs.
 - (C) Operation and maintenance costs based on a projected 20-year life of the system or component.
 - (D) Energy costs.

§ 1-406 **Renewal Application Process for Innovative/Alternative Systems and Components**

An application for renewal of an approval shall be submitted on a form prepared by the Secretary. The application form shall require the following information:

- (1) Results of any tests not submitted with the original application for approval of the system or component.
- (2) Any approvals or denials by a State or Province not submitted with the original application for approval of the system or component.
- (3) A statement as to whether there were design changes or modifications to the innovative/alternative system or component since the last approval.
 - (A) If there was a change or modification to the design of the innovative/alternative system or component, the manufacturer shall include a full description of the changes.
 - (B) If the change or modification affects performance of the system or component, the manufacturer or designer must submit a new application for approval of the system or component.
- (4) Any updates needed for Vermont-specific manuals and design drawings so that they are in compliance with these Rules.
- (5) Confirmation of manufacturer contact information.
- (6) Confirmation of the availability of the system or component, parts, and trained and approved service providers for the system or component.
- (7) Confirmation that the manufacturer met the conditions of the approval letter including the monitoring of the distribution of the innovative/alternative system or component and the annual reporting requirements.
- (8) A recalculation of the operation and maintenance costs based on a projected 20-year life of the system or component.

§ 1-407 **Standards and Protocols for Testing Innovative/Alternative Systems and Components**

- (a) Bench testing or field testing of innovative/alternative systems or component shall comply with the following standards or protocols:
 - (1) ANSI/NSF Standard 40 – Residential Wastewater Treatment Systems;
 - (2) ANSI/NSF Standard 24-5 – Wastewater Treatment Systems; Nitrogen Reduction;
 - (3) Canadian BNQ Standard NO 3680-910;

- (4) European (EU) Standard EN 12566-3; or
 - (5) other standards and protocols developed by independent standards organizations and approved by the Secretary.
- (b) Field testing shall be conducted by a testing facility that complies with the following standards or protocols:
- (1) EPA/NSF – Protocol for the Verification of Wastewater Treatment Technologies;
or
 - (2) EPA Environmental Technology Verification Program protocol for the Verification of Residential wastewater treatment technologies for nutrient reduction.

Subchapter 5 – Administrative Reconsiderations; Appeals; Enforcement

§ 1-501 Administrative Reconsideration

- (a) An applicant for a permit or permit amendment, a person requesting a determination of the Secretary pursuant to a provision in these Rules that allows for such a determination, or a permittee, may request that a decision made in a Regional Office be reviewed and reconsidered by the Regional Office Programs Manager by submitting such request in writing within 60 days of the date of the decision to the Regional Office Programs Manager.
 - (1) The request shall specify which aspects of the decision are at issue, the reasons why the person believes the decision to be in error, and the decision requested of the Regional Office Programs Manager.
 - (2) The Regional Office Programs Manager may call on other individuals within or outside the Department who have expertise appropriate to the case to assist in their review including the Regional Office personnel. The Regional Office Programs Manager shall issue a written decision in writing within 60 days of receipt of a request made pursuant to Subsection (a), unless the requester and Regional Office Programs Manager mutually agree to an extension of this time period.
 - (3) The decision of the Regional Office Programs Manager shall constitute the final decision by the Secretary if reconsideration of the decision is not requested pursuant to Subsection (b).

- (b) Any person who requested a reconsideration under Subsection (a) may, within 30 days of the date of the decision by the Regional Office Programs Manager, request that Regional Office Programs Manager's decision be reviewed and reconsidered by the Director by submitting such request in writing to the Director.
 - (1) The request shall specify which aspects of the decision are at issue, the reasons why the person believes the decision to be in error, and the decision requested of the Director.
 - (2) Within 30 days of receipt of the request, the Director shall convene a meeting with the requester and Division personnel. The Director may call on other individuals within or outside the Department who have expertise appropriate to the case to assist in their review including the Regional Office Programs Manager and Regional Office personnel.
 - (3) The Director shall issue a written decision within 30 days of the meeting. This time period may be extended by mutual agreement of the requester and Director. This written decision shall constitute the final decision by the Secretary.

§ 1-502 Appeal of Final Agency Decision

- (a) A person aggrieved by a final act or decision of the Secretary under these Rules may appeal to the Environmental Division of the Vermont Superior Court in accordance with 10 V.S.A., Chapter 220.

- (b) The period for appealing a decision to the Environmental Division is stayed if, within the appeal period, a request is received by the Secretary seeking reconsideration of the

decision pursuant to § 1-501 and the decision is one for which reconsideration is available pursuant to § 1-501. The full appeal period shall be available following the Secretary's final decision in response to the request for reconsideration.

§ 1-503 Enforcement

- (a) The Secretary may initiate an enforcement action against a person, in accordance with the provisions of 10 V.S.A., Chapter 201 or 10 V.S.A. Chapter 211, if the Secretary determines that such person:
 - (1) has taken, or caused to be taken, an action that requires a permit or permit amendment under these Rules without first obtaining the required permit or permit amendment;
 - (2) has taken, or caused to be taken, an action that is in non-compliance with a permit or permit amendment issued under these Rules;
 - (3) is, or has been, in non-compliance with any order or assurance of discontinuance which addresses compliance with these Rules; or
 - (4) has otherwise not complied with the provisions of these Rules.

- (b) If the Secretary determines that a licensed professional engineer or a Class A, B, or BW designer, as a result of the person's failure to exercise reasonable professional judgment, submits design or installation information that is untrue or incorrect, the Secretary may notify the Office of Professional Regulation.

Subchapter 6 – Delegation

§ 1-601 Full or Partial Delegation

- (a) A municipality may request that it be delegated the authority to implement the provisions of 10 V.S.A., Chapter 64, except §§ 1975, 1976 and 1978, in lieu of the Agency, through administration of the permitting program set forth in these Rules for all types of wastewater systems and potable water supplies located within the municipality. This is called full delegation.
- (b) A municipality may alternatively request that it be partially delegated, called partial delegation, the authority to implement the provisions of 10 V.S.A., Chapter 64, except §§ 1975, 1976 and 1978, in lieu of the Agency, through administration of the permitting program set forth in these Rules for only those projects that consist of buildings or structures or campgrounds that are served by both:
 - (1) sanitary sewer service lines connected to or that will connect to a sanitary sewer collection line owned and controlled by the municipality; and
 - (2) water service lines connected or that will connect to a water main owned and controlled by the municipality.

§ 1-602 Process for Delegation

- (a) A municipality requesting the full or partial delegation shall submit the following information to the Agency in writing:
 - (1) A request for delegation indicating if full or partial delegation is sought.
 - (2) The name, mailing address, and phone number of the chair of the local legislative body of the municipality submitting the request;
 - (3) The name, mailing address, phone number, and license number of the designer or professional engineer who will be responsible for reviewing applications and issuing permits pursuant to these Rules;
 - (4) A description of the process the municipality will use for accepting and reviewing applications and for issuing permits;
 - (5) A statement signed by the chair of the local legislative body committing to administer the program in accordance with these Rules;
 - (6) For municipalities cooperating to manage the program, separate requests from each municipality for delegation of authority plus a copy of an inter-municipal agreement signed by the chair of each local body indicating the process agreed upon and the roles and responsibilities of the member municipalities; and
 - (7) Authority for the Secretary or their designee to enter the municipal property during normal working hours to review records related to the municipality's administration of these Rules.
- (b) The delegation of authority from the Agency to the municipality shall be executed through a written agreement signed by the chair of the local legislative body on behalf of the municipality and the Commissioner that identifies the scope of the delegation and the parties' obligations.

§ 1-603 Performance Expectations for a Delegated Municipality

Municipalities receiving delegation under this Subchapter shall:

- (1) Administer the program in conformance with these Rules and with the procedures and practices adopted by the Secretary that interpret these Rules.
- (2) If receiving full delegation, employ a designer to review applications and issue permits pursuant to these Rules.
- (3) If receiving partial delegation, employ a designer or employ a professional engineer practicing within the scope of their engineering specialty to review applications and issue permits pursuant to these Rules.
- (4) Require the designer or a professional engineer employed to review applications and issue permits pursuant to these Rules to attend Department training programs, seminars, and meetings related to the administration of these Rules that the Agency requires staff administering these Rules to attend.
- (5) Issue permits for sanitary sewer service lines and sanitary sewer collection lines that convey wastewater to a wastewater treatment facility or indirect discharge system only if there is capacity in the facility or system to treat the constituents of the wastewater and dispose of the design flow identified in § 1-803 for each building or structure or campground to be served by the sanitary sewer service line or sanitary sewer collection line.
- (6) Issue permits for water service lines connecting to water mains only if there is capacity in the public water system to supply the design flow identified in § 1-803 for each building or structure or campground to be served by the water service line.
- (7) Include in each permit standard conditions that are provided by the Agency.
- (8) Act as the custodian of all records obtained or created in administering these Rules and maintain the records in conformance with the Agency's records schedules that would control the disposition of such records were the Agency the custodian of such records.
- (9) Make electronic copies of all documents received or prepared during the course of an application review that were used to make a decision on the particular application available in a web-based format so that they may be examined from remote locations by Agency staff and members of the public.
- (10) Maintain and operate an electronic tracking system for applications and permitting decisions that includes the applicant's name, address, and phone number; a project description; design flow for the potable water supply and wastewater system; application receipt date; the date the municipality deems the application to be administratively complete; dates of correspondence from municipal personnel to the applicant seeking additional application information during the review of an administratively complete application; dates for the receipt of additional information from the applicant; and date of the final decision.
- (11) Submit an annual report to the Agency by February 15 of each calendar year that lists the number of applications received, the number of permits or denials issued, the number of permits issued that include the use of innovative/alternative systems or components, the number of annual inspections reports received for permits issued that include innovative/alternative systems or components, the average in-house application processing time, and the average application

processing time from the date of receipt of an administratively complete application to the date of the final decision.

- (12) Take timely and appropriate enforcement for violations of municipality-issued permits and for violations of these Rules within the municipality's boundaries pursuant to 10 V.S.A., Chapter 201.
- (13) Be responsible for all costs of administering these Rules pursuant to their delegation agreement and establish permit review fees in an amount sufficient to support the municipal services. If delegation is revoked pursuant to § 1-606, promptly provide copies of all documents and required permit tracking data related to the permits processed during the period of delegation to the Secretary. Electronic or microfilm copies will be acceptable.

§ 1-604 Agency Responsibilities

- (a) Upon delegating the authority to implement these Rules to a municipality, the Secretary shall deliver the following to the municipality:
 - (1) Procedures and practices adopted by the Secretary that interpret these Rules.
 - (2) A list of standard conditions to be included in permits issued pursuant to these Rules.
 - (3) The record schedules adopted by the Agency that control the disposition of records obtained or created in administering these Rules.
 - (4) Electronic copies of the historical permitting documents for permits issued by the State for projects in the municipality for use in administering the permit program.
- (b) The Secretary may audit a delegated municipality's administration of these Rules to assure the municipality's administration complies with the Rules, to perform quality control and ensure a level of consistency between the municipality's review and the review by a Regional Office, to gather information, or to investigate a complaint received in reference to the municipality's administration of these Rules.
- (c) Notwithstanding delegation to a municipality pursuant to § 1-602, the Secretary, after consultation with the municipality, may institute enforcement proceedings against a person for violations of these Rules within the municipalities' municipal boundaries when the delegated municipality does not or cannot address non-compliance, or when the Secretary determines that enforcement is necessary to protect human health and the environment.
- (d) The administrative reconsideration process established in § 1-501 is not available for permitting decisions by delegated municipalities made pursuant to their delegation agreement. Municipalities may develop a process for administrative reconsideration of such permitting decision.

§ 1-605 Permit Fees and Enforcement Penalties

- (a) Delegated municipalities shall retain permit review fees for all municipal-issued permits except as indicated in Subsection (b) and shall retain all penalties collected from enforcement actions taken by the municipality within the scope of their delegated authority.

- (b) Municipalities whose delegation authority is revoked or who work with the Agency to terminate their delegation shall remit to the Agency the application fees for any permit application that reverts to the Agency for issuance.

§ 1-606 Revocation of Delegation

- (a) The Secretary may revoke delegation to a municipality for one or more of the following reasons:
 - (1) violation of the delegation agreement;
 - (2) false or misleading information submitted in support of an application for delegation;
 - (3) issuance of permits for sanitary sewer service lines, sanitary sewer collection lines, or water service lines when the receiving facility or system has insufficient capacity for the design flow approved in the permits;
 - (4) issuing permits that do not comply with these Rules; or
 - (5) failure to take timely and appropriate enforcement actions under these Rules.

- (b) Process for revocation
 - (1) Prior to commencing revocation proceedings, the Secretary shall work with the delegated municipality to achieve compliance with these Rules.
 - (2) Upon investigation of a complaint leading the Secretary to conclude that revocation is warranted, or on their own motion, the Secretary shall schedule a hearing for revocation and issue a notice of pending revocation to the municipality at least two weeks prior to the hearing.
 - (3) A notice of pending revocation shall include the following:
 - (A) the legal authority for revocation;
 - (B) a brief statement of the proposed basis for revocation;
 - (C) notice that the Secretary will hold a hearing for the purpose of determining whether delegation shall be revoked; and
 - (D) the date, time, and place the hearing will be held.
 - (4) A hearing shall be conducted in accordance with Subsection (c) and the Secretary shall issue a written decision within 30 days of conclusion of the hearing. If the decision is to revoke authority, the decision shall establish a timeline for transfer of records to the Agency.

- (c) Hearing
 - (1) A hearing for revocation shall be conducted in the Regional Office within closest driving distance to the delegated municipality's municipal offices, unless an alternative location is agreed to by the Secretary and delegated municipality.
 - (2) The hearing for revocation shall be treated as a contested case and conducted in accordance with the provisions of 3 V.S.A. §§ 809–813, and this section.
 - (3) The local legislative body of the municipality that is the subject of the proposed revocation is a party by right. Other persons who demonstrate to the Secretary that their interests are directly affected by delegation revocation shall be afforded party status to participate in the proceedings.
 - (4) Any party to the revocation proceedings shall either appear in person or shall be represented by an attorney.

- (5) The burden of proving that the delegation should be revoked shall be upon the Secretary.
 - (6) Upon the written request of a party filed at least 10 days before the hearing, the hearing shall be transcribed by a qualified stenographer or recorded on an electronic sound device. Costs shall be borne by the requesting party. The requesting party shall provide one copy of the transcript to the Secretary without cost; other parties wishing a copy shall reimburse the requesting party on a prorated basis.
- (d) In response to a notice of pending revocation, the delegated municipality may waive the right to have a hearing and agree to revocation initiated by the Secretary.
- (e) Applications in Process
- (1) No additional applications shall be accepted by a municipality following the municipality's submission of a request for voluntary revocation.
 - (2) Applications in process by a municipality that has received a Notice of Pending Revocation shall continue to be processed by the municipality until such time as delegation is revoked.
- (f) Appeal of a decision to revoke delegation shall be to the Environmental Court in accordance with 10 V.S.A., Chapter 220.

Subchapter 7 – Designer Scope of Authority, Examination, and Continuing Education

§ 1-701 General Requirements

- (a) No person, except professional engineers, shall submit a design to the Secretary for a wastewater system or potable water supply without first obtaining a Class A, B, or BW wastewater and potable water supply designer license from the Office of Professional Regulation.
- (b) A designer or professional engineer employed to review applications and issue permits pursuant to these Rules by a municipality with delegated authority pursuant to Subchapter 6, and other employees from the designer's or professional engineer's firm or business, shall not complete a design, any part of an application, an installation certificate, or other certification for a wastewater system or potable water supply located, or proposed to be located, within the municipality employing them.

§ 1-702 Scope of Authority for Class 1 Designers and Professional Engineers

- (a) Class 1 Designers are licensed professional engineers who:
 - (1) are practicing within the scope of their engineering specialty; and
 - (2) if designing soil-based wastewater systems:
 - (A) received from the Vermont Board of Professional Engineering designation that he or she passed a college-level soil identification course with specific instruction in the areas of soil morphology, genesis, texture, permeability, color, and redoximorphic features; or
 - (B) passed a soil identification exam administered or approved by the Secretary.
- (b) Class 1 Designers may perform the site evaluation, application preparation, and design and installation certifications required under these Rules for the design of all wastewater systems and potable water supplies.
- (c) Professional engineers practicing within the scope of their engineering specialty who are not Class 1 Designers may:
 - (1) perform the site evaluation, application preparation, and certification required under these Rules for the design of water service piping, water service lines, sanitary sewer service lines, and sanitary sewer collection lines.
 - (2) perform the site evaluation, application preparation, and certification required under these Rules for the design of a soil-based wastewater system if the engineer retains one or more designers who are Class 1, Class A, Class B, or Class BW to perform all aspects of site evaluation, application preparation, and certification under these Rules for soil evaluation. In such cases, the name of the designer responsible for the soil evaluation for the application shall be included as a part of the permit application and certification.

§ 1-703 Scope of Authority for Class A Designers

- (a) Class A Designers may perform the site evaluation, application preparation, and design and installation certifications required under these Rules for the design of the following wastewater systems and potable water supplies:
- (1) a soil-based wastewater system with a design flow of 1350 gallons per day or less, including a system with a wastewater pump station that discharges to a gravity flow sanitary sewer collection line, gravity flow sanitary sewer service line, or distribution box;
 - (2) a sanitary sewer service line with a design flow of 1350 gallons per day or less, including a sanitary sewer service line that uses a wastewater pump station that discharges to a gravity flow sanitary sewer collection line or gravity flow sanitary sewer service line; and
 - (3) a potable water supply that serves only one single-family residence with a design flow of 1350 gallons per day or less, including a water service line with a fire suppression system with no more than 2 sprinkler heads.
- (b) Notwithstanding Subsection (a), a Class A designer shall not perform the site evaluation, application preparation, and design and installation certifications required under these Rules for the design of a wastewater system or potable water supply that includes or falls within one of the following:
- (1) a soil-based wastewater system that uses pressure distribution;
 - (2) a soil-based wastewater system that uses subsurface drip distribution;
 - (3) a soil-based wastewater system with a leachfield in a mound or bottomless sand filter;
 - (4) a soil-based wastewater system with a leachfield disposing of filtrate effluent;
 - (5) a soil-based wastewater system designed using the 2-year time of travel management zone;
 - (6) a soil-based wastewater system that includes a constructed wetland;
 - (7) a soil-based wastewater system that uses a storage and dose approach;
 - (8) a soil-based wastewater system that disposes of high strength wastewater, and for which design flow is determined pursuant to § 1-803(f)(2) or (3);
 - (9) a soil-based wastewater system that disposes of high strength wastewater and serves a building or structure with a use as a brewery;
 - (10) an innovative/alternative system, or wastewater system that uses innovative/alternative components, that has received pilot or experimental approval pursuant to Subchapter 4;
 - (11) an innovative/alternative system, or wastewater system that uses innovative/alternative components that has received general use approval pursuant to Subchapter 4, unless the approval authorizes a Class A designer to design such systems;
 - (12) a sanitary sewer service line that includes manholes or connects to a pressure sanitary sewer collection line;
 - (13) a sanitary sewer collection line;
 - (14) a potable water supply that serves any building or structure or campground other than a single-family residence;

- (15) a potable water supply that includes a water treatment system, the installation and use of which is not exempt under § 1-304(19);
 - (16) a potable water supply with a surface water potable water source; or
 - (17) a water service line that includes a fire hydrant or fire suppression system except as provided in Subsection (a)(3).
- (c) Class A designers shall not complete design or installation certifications for wastewater systems and potable water supplies they are not authorized to design.

§ 1-704 Scope of Authority for Class B Designers

- (a) Class B designers may perform the work within a Class A designer's scope of authority and the site evaluation, application preparation, and design and installation certifications required under these Rules for the design of the following wastewater systems:
- (1) a soil-based wastewater system that uses pressure distribution;
 - (2) a soil-based wastewater system that uses subsurface drip distribution;
 - (3) soil-based wastewater systems with a leachfield in a mound or bottomless sand filter;
 - (4) a soil-based wastewater system with a leachfield disposing of filtrate effluent;
 - (5) a soil-based wastewater system designed using the 2-year time of travel management zone;
 - (6) a soil-based wastewater system that includes a constructed wetland;
 - (7) a soil-based wastewater system that disposes of high strength wastewater and does not include the use of treatment or innovative/alternative components to reduce the strength to low;
 - (8) an innovative/alternative system, or wastewater system that uses innovative/alternative components, that has received general use approval pursuant to Subchapter 4, unless the approval requires a Class 1 designer to design such systems; and
 - (9) a sanitary sewer collection line that meets the following:
 - (A) the total design flow into the collection line is 1350 gallons per day or less;
 - (B) the collection line is less than 400 feet in length; and
 - (C) the collection line does not have a manhole and is not required to have a manhole under § 1-1002(j).
- (b) Notwithstanding Subsection (a), a Class B designer shall not perform the site evaluation, application preparation, and design and installation certification required under these Rules for the design of a wastewater system or potable water supply that includes or falls within one of the following:
- (1) a soil-based wastewater system that uses a storage and dose approach;
 - (2) a soil-based wastewater system that disposes of high strength wastewater and includes the use of treatment or innovative/alternative components to reduce the strength to low strength;
 - (3) an innovative/alternative system, or wastewater system that uses innovative/alternative components, that has received general use approval

- pursuant to Subchapter 4, when the approval requires a Class 1 designer to design such systems;
- (4) an innovative/alternative system, or wastewater system that uses innovative/alternative components, that has received pilot or experimental approval pursuant to Subchapter 4;
 - (5) a sanitary sewer service line or sanitary sewer collection line that includes manholes;
 - (6) a sanitary sewer service line or sanitary sewer collection line that connects to a pressure sanitary sewer collection line;
 - (7) a potable water supply that serves any building or structure or campground other than a single-family residence;
 - (8) a potable water supply that includes a water treatment system the installation and use of which is not exempt under § 1-304(19);
 - (9) a potable water supply with a surface water potable water source; or
 - (10) a water service line that includes a fire hydrant or fire suppression system except as provided in § 1-703(a)(3).
- (c) Class B designers shall not complete design or installation certifications for wastewater systems and potable water supplies they are not authorized to design.

§ 1-705 Scope of Authority for Class BW Designers

- (a) Class BW designers may perform the work within a Class A or Class B designer's scope of authority and the site evaluation, application preparation, and design and installation certifications required under these Rules for the design of a potable water supply with a total design flow of 1350 gallons per day or less regardless of the number of buildings or structures or campgrounds served.
- (b) Notwithstanding Subsection (a), a Class BW designer shall not perform the site evaluation, application preparation, and design and installation certification required under these Rules for the design of a wastewater system or potable water supply that includes or falls within one of the following:
 - (1) a soil-based wastewater system that uses a storage and dose approach;
 - (2) a soil-based wastewater system that disposes of high strength wastewater and includes the use of pre-treatment or innovative/alternative components to decrease the strength of the wastewater;
 - (3) an innovative/alternative system, or wastewater system that uses innovative/alternative components, that has received general use approval pursuant to Subchapter 4, when the approval requires a Class 1 designer to design such systems;
 - (4) an innovative/alternative system, or wastewater system that uses innovative/alternative components, that has received pilot or experimental approval pursuant to Subchapter 4;
 - (5) a sanitary sewer service line or sanitary sewer collection line that includes manholes;
 - (6) a sanitary sewer service line or sanitary sewer collection line that connects to a pressure sanitary sewer collection line;

- (7) a potable water supply that includes a water treatment system the installation and use of which is not exempt under § 1-304(19);
 - (8) a potable water supply with a surface water potable water source; or
 - (9) a water service line that includes a fire hydrant or fire suppression system except as provided in § 1-703(a)(3).
- (c) Class BW designers shall not complete design or installation certifications for wastewater systems and potable water supplies they are not authorized to design.

§ 1-706 Examinations

- (a) Examination to become a Class A designer shall consist of both a written component and a field component prepared and approved by the Secretary that test the individual's knowledge of soil identification and the requirements of these Rules for those wastewater systems and potable water supplies that a Class A designer is authorized by these Rules to design.
- (b) Examinations to become a Class B designer shall consist of the Class A examinations and a written component prepared and approved by the Secretary that tests the individual's knowledge of the requirements of these Rules for those wastewater systems and potable water supplies that a Class B designer is authorized by these Rules to design.
- (c) Examinations to become a Class BW designer shall consist of the Class A and Class B examinations and a written component prepared and approved by the Secretary that tests the individual's knowledge of designing potable water supplies that a Class BW designer is authorized by these Rules to design.

§ 1-707 Continuing Education for Class A, B, and BW Designers

- (a) To provide continuing education hours toward a designer's license renewal, a course must be Secretary approved as either relevant to the siting and design of a wastewater system or potable water supply or in-field or laboratory related courses pertaining to soil.
- (b) Any person may request that the Secretary review a course to determine whether to approve the course for continuing education hours.
- (1) When approving a course, the Secretary shall identify the:
 - (A) type of the course;
 - (B) whether in-field, laboratory, or interactive distance learning;
 - (C) the number of hours completion of the course provides;
 - (D) whether the hours qualify as general hours or soil hours; and
 - (E) whether the provider is able to verify attendance and participation.
 - (2) Courses that consist of passive listening or viewing of recorded matter shall not be approved for continuing education hours.
- (c) The Secretary shall provide at least one soil course each year to assist designers fulfilling their continuing education hours.

§ 1-708 Audit of Designers

- (a) The Secretary may review, on a random basis, or in response to a complaint, or on their own motion, the performance of a designer, including the following and any work completed by the designer in association with the following:
 - (1) soil analysis and testing procedures employed by the designer;
 - (2) systems designed by the designer; and
 - (3) designs approved or recommended for approval by the designer.

- (b) The Secretary may use the results to work with a designer to reduce the number of administratively and technically incomplete or deficient applications.

- (c) The Secretary may provide the results of the audit to the Office of Professional Regulation.

Subchapter 8 – General Technical Standards for Wastewater Systems and Potable Water Supplies

§ 1-801 Basic Requirements

- (a) All buildings or structures or campgrounds shall have a wastewater system that complies with the technical standards in this Subchapter and Subchapters 9 and 10 except as provided in § 1-301(b), § 1-802, or an approval for an innovative/alternative system or component.
 - (1) Except as provided in Subsection (a)(2), the wastewater system shall be physically connected to the building or structure it serves.
 - (2) The wastewater system serving a building or structure may be a wastewater system that is not physically connected to the building or structure provided the wastewater system is physically connected to a separate building or structure and the buildings or structures are on the same lot and not more than 500 feet apart.
- (b) A wastewater system shall be maintained to ensure that the components of the wastewater system meet the technical standards in this Subchapter and Subchapters 9 and 10 and do not operate improperly.
- (c) All buildings or structures or campgrounds shall have a potable water supply that complies with the technical standards in this Subchapter and Subchapters 11 and 12 except as provided in § 1-301(b), § 1-802, or an approval for an innovative/alternative system or component.
 - (1) Except as provided in Subsection (c)(2), the potable water supply shall be physically connected to the building or structure it serves.
 - (2) The potable water supply serving a building or structure may be a potable water supply that is not physically connected to the building or structure provided the potable water supply is physically connected to a separate building or structure and the buildings or structures are on the same lot and not more than 500 feet apart.
- (d) A potable water supply shall be maintained to ensure that the components of the potable water supply meet the technical standards in this Subchapter and Subchapters 11 and 12 and do not operate improperly.
- (e) All dependent campsites in a campground shall be within 400 feet of a toilet facility. The toilet facility may consist of water carried toilets, vault privies, composting toilets, or incinerating toilets.
- (f) There shall be at least 1 toilet to serve each group of 10 or fewer dependent campsites in a campground.
- (g) Each component of a wastewater system shall be sized to convey, treat, or dispose of the design flow associated with the component and identified in § 1-803.

- (h) Each component of a potable water supply shall be sized to supply or convey the design flow associated with the component and identified in § 1-803.
- (i) A water faucet shall be provided within 400 feet of any dependent campsite in a campground. Common drinking vessels at faucets are prohibited.
- (j) At least one dumping station shall be provided per campground unless:
 - (1) all campsites have individual sanitary sewer service lines; or
 - (2) the campground consists entirely of tent sites and the campground prohibits the use of camping units with interior plumbing.
- (k) Each dumping station in a campground shall:
 - (1) serve no more than 100 dependent campsites;
 - (2) be designed with a concrete apron that slopes to the sanitary sewer service line inlet; and
 - (3) be supplied with piped water under pressure for flushing and cleaning of the concrete apron after each use.

§ 1-802 Variances

- (a) An application for a permit or permit amendment may include a request, prepared by a designer, for a variance from one or more technical standards in this Subchapter and Subchapters 9, 10, 11, and 12 if the application meets one of the following:
 - (1) involves the construction of a replacement system or replacement supply and the variance is sought for the replacement system or replacement supply, provided the replacement system is not proposed in lieu of a replacement area and in the same application as the wastewater system it would replace;
 - (2) involves the change in use of a single-family residence from seasonal to year-round use and the variance is sought for the wastewater system or potable water supply proposed to serve the single-family residence, provided no holding tank is proposed as part of the wastewater system;
 - (3) involves the subdivision of an improved lot, and, if desired, the construction of a replacement system in lieu of a replacement area, and the variance is sought for the replacement area or replacement system, provided the lot is improved with, and the replacement area or replacement system is proposed to serve, either:
 - (A) up to two single-family residences or one duplex; or
 - (B) up to two buildings or structures, two campgrounds, or one building or structure and one campground, where the total design flow for the uses is 560 gallons per day or less.
- (b) Variances are not available in circumstances other than those identified in Subsection (a).
- (c) Notwithstanding Subsection (a), a variance from a technical standard in these Rules shall not be granted when an increase in design flow is sought for the wastewater system or potable water supply.

- (d) An application that includes a request for a variance shall identify the specific provision and technical standard in these Rules for which the applicant is requesting a variance, identify the alternative design standard requested, and contain the site plan, detail sheets, narrative, or data that supports the grant of such a variance pursuant to the standard identified in Subsection (e) or (f).
 - (1) The burden shall be on the person requesting the variance to provide information that would enable the Secretary to reach each conclusion identified in Subsection (e) or (f).
 - (2) The Secretary may request additional information that he or she deems necessary to determine whether to grant a variance pursuant to Subsection (e) or (f).

- (e) The Secretary shall grant a variance from a technical standard in these Rules when the Secretary reaches the following conclusions:
 - (1) Full compliance with the technical standard cannot be achieved unless the variance request is for a replacement system or replacement supply under § 1-802(f).
 - (2) The variance is the minimum necessary considering both cost and the potential impacts on human health and the environment. In reaching this determination, the Secretary shall presume that the following designs are the minimum necessary considering the cost and impacts on human health and the environment:
 - (A) For the design of a soil-based wastewater system, when it is determined that a reduction of no more than 4 inches in the depths of naturally occurring soil required pursuant to § 1-903 is not needed to protect the water table, a variance from one or more technical standards in § 1-903 is available and the following variances are available:
 - (i) Variances from the requirement for a pump station and that allow the development of an in-ground leachfield.
 - (ii) Variances that allow an in-ground leachfield instead of a pump station and an at-grade leachfield.
 - (iii) Variances that allow an at-grade leachfield instead of a leachfield in a mound or bottomless sand filter.
 - (B) For the design of a soil-based wastewater system, when:
 - (i) an increase to the maximum application rate is necessary pursuant to § 1-911 when:
 - (I) there is a lack of available area to construct the leachfield but the designer submits information, and the Secretary agrees, the leachfield will function without failing; or
 - (II) a hydrogeological analysis supports a decrease in the size of the leachfield; or
 - (ii) meter data that supports a reduction in the design flow identified in Table 8-1, Table 8-2, or Table 8-3 for the building or structure. Note, any change in use of the building or structure shall be limited to the permitted design flow unless it is demonstrated the system is in full compliance with the technical standards in Chapters 9 and 10.

- (C) For the design of a wastewater system, when a proposed leachfield or septic tank cannot meet the isolation required pursuant to § 1-912(a) or § 1-912(b) from an existing potable water source when:
 - (i) a designer demonstrates that the proposed location or design of the leachfield or septic tank will increase protection of the source relative to the existing leachfield or tank; or
 - (ii) the owner of the affected potable water source files an application for modifications to the source that provides an increase in protection of the source offsetting the lack of horizontal separation to the proposed leachfield or tank.
- (D) For the design of a potable water supply, when a proposed groundwater potable water source cannot meet the isolation required pursuant to § 1-1104(e) from an existing leachfield or septic tank, and the proposed potable water source is designed to include casing that exceeds the casing required pursuant to § 1-1206 or to include grouting of any annular space of the proposed potable water source, a variance from § 1-1104(e) for isolation from the existing leachfield or septic tank is available.
 - (3) The variance will not allow the wastewater system or potable water supply to function as a failed supply or failed system.
 - (4) If sought for a replacement system or replacement supply, the replacement system or replacement supply will provide equal to or better protection to human health or the environment than the wastewater system or potable water supply it is replacing. In reaching this determination the Secretary shall consider, among other factors, if the replacement system or replacement supply will provide equal or better protection of the groundwater, will provide equal or better protection of surface water, and will provide equal or better protection for potable water sources and public water sources.
- (f) Notwithstanding Subsection (e):
 - (1) When a variance is sought for a replacement system or replacement supply that will replace a wastewater system or potable water supply exempt from the permitting requirements of this Subchapter under § 1-303, the conclusion in Subsection (e)(1) is not applicable, and the Secretary shall grant a variance from a technical standard in these Rules when the Secretary reaches the conclusions in Subsection (e)(2), (3), and (4).
 - (2) When a variance is sought in the circumstance identified in Subsection (a)(3), the conclusion in Subsection (e)(1) is not applicable, and the Secretary shall grant a variance from a technical standard in these Rules when the Secretary reaches the conclusions in Subsection (e)(2), (3), and (4) and concludes that full compliance with the technical standard cannot be achieved within 500 feet of each building or structure or campground proposed to be served by the replacement area or replacement system.
- (g) The grant of a variance by the Secretary shall be in writing in the permit for the wastewater system or potable water supply for which the variance was requested by identifying that the permit includes the grant of a variance and by identifying both the

technical standard for which the variance is granted and the design modification or alternative design standard approved.

- (h) The grant of a variance shall not relieve the applicant of the responsibility to comply with all other provisions of these Rules and applicable State and local laws.

§ 1-803 Design Flows

- (a) For the purposes of this Section, the term “employee,” when associated with a non-residential use of a residence, does not include employees residing in the residence whose water usage is included as part of a residential use.
- (b) For the purposes of this Section, the term “meal” means any food service that includes more than coffee, tea, water, other beverages, and pre-packaged food. Meals include any food service that the Vermont Department of Health determines to be a meal or requires a Health License to be prepared on the premises.
- (c) The design flow for individual components of a wastewater system and potable water supply, and the design flow for a replacement area, that will serve a single-family residence on a lot with no other buildings or structures and with no campground, shall be calculated based on a minimum of 2 bedrooms, regardless of whether the residence will contain only one bedroom.
- (d) The design flow for individual components of a wastewater system and a potable water supply, and the design flow for a replacement area, that will serve buildings or structures with a residential use shall be calculated using one of the following methods for the total living units served:
 - (1) The design flow of 70 gallons per day per person at the maximum residential occupancy proposed for each living unit, provided the resulting design flow is not less than the design flow calculated using the following minimum design standards:
 - (A) a living unit contains at least 1 bedroom, except as provided in Subsection (c);
 - (B) the first 3 bedrooms in a living unit contain a minimum occupancy of 2 persons per bedroom; and
 - (C) each additional bedroom beyond 3 contains a minimum occupancy of 1 person per bedroom.
 - (2) The design flow specified in Table 8-1.
- (e) The design flow for individual components of a wastewater system and potable water supply, and the design flow for a replacement area, that will serve campgrounds shall be calculated using the design flow specified in Table 8-2.
- (f) The design flow for individual components of a wastewater system and potable water supply, and the design flow for a replacement area, that will serve buildings or structures with a non-residential use shall be calculated using one of the following methods:

- (1) The design flow specified in Table 8-3 for the maximum quantity of each unit proposed.
- (2) A Secretary approved design flow using water meter data authorized pursuant to § 1-804.
- (3) For uses not appearing in Table 8-3:
 - (A) when the wastewater system is a soil-based wastewater system, or a sanitary sewer service line that conveys wastewater to an indirect discharge system, a design flow approved by the Secretary following receipt of the designer's proposal for a design flow that will accommodate the wastewater strength and characteristics and the amount of water necessary for the proposed use, taking into account:
 - (i) the design flows for uses in Table 8-3 with similar water usage and wastewater strength and characteristics;
 - (ii) the submission of water use data that meets the requirements in § 1-804(d) and (e) and the submission of wastewater strength and characteristics that meets the requirements of § 805(c), accompanied by a request to establish a design flow for the proposed use that includes the information identified in § 1-804(a) and (c); or
 - (iii) for commercial, industrial, manufacturing, or agricultural uses, the design flow determined by other methods approved by the Secretary. Other methods may include manufacturer's specifications and method used to determine design flow and wastewater strength and characteristics; flows and wastewater strength and characteristics from other States or the Environmental Protection Agency; or published and peer review studies by States, Colleges, or Universities that include flows and wastewater strength and characteristics.
 - (B) when the wastewater system is a sanitary sewer service line that conveys wastewater to a wastewater treatment facility, a design flow approved by the Secretary following receipt of the designer's proposal for a design flow that will accommodate the wastewater strength and the amount of water necessary for the proposed use, taking into account:
 - (i) the design flows for uses in Table 8-3 with similar water usage and wastewater strength;
 - (ii) the submission of water use data that meets the requirements in § 1-804(d) and accompanied by a request to establish a design flow for the proposed use that includes the information identified in § 1-804(b) and (c); or
 - (iii) for commercial, industrial, manufacturing, or agricultural uses, the design flow determined by other methods approved by the Secretary. Other methods may include manufacturer's specifications and method used to determine design flow and wastewater strength and characteristics; flows and wastewater strength and characteristics from other States or the Environmental Protection Agency; or published and peer review studies by States,

Colleges, or Universities that include flows and wastewater strength and characteristics.

- (g) In the following situations, a designer may reduce, by the reduction indicated as follows, the design flow calculated pursuant to Subsection (d), (e), and (f) for individual components of a wastewater system or potable water supply:
- (1) If the living unit served is senior housing but does not include assisted living or nursing care associated with the senior housing, the design flow for a component that will serve the living unit may be reduced to 105 gallons per day (based on 1.5 persons per living unit).
 - (2) If not more than four living units will be served by a component and each living unit contains only composting or incinerating toilets, the design flow for the component may be reduced by 25 percent.
 - (3) If a building or structure, other than in a living unit, or a campground, that will be served by a component contains only composting or incinerating toilets and the Secretary determines that a reduction in design flow proposed by the applicant's designer for the component will not increase the probability the system or supply will fail, the design flow for the component may be the design flow approved by the Secretary.
- (h) The design flow for individual components of a wastewater system or potable water supply, and the design flow for a replacement area, that will serve a building or structure or campground with multiple uses, whether residential or non-residential, shall be determined by calculating the maximum sum of the design flows for each use of the building or structure or campground in any 24-hour period.
- (i) When a wastewater system includes a gravity sanitary sewer service line or gravity sanitary sewer collection line exceeding 500 feet in total length, individually or in combination, the following infiltration design flow shall be added to the design flow identified in Subsection (c) through (h) for individual components of the wastewater system that receive flow from the service or collection line:
- (1) 300 gallons per inch of diameter per mile of pipe per day; or
 - (2) 200 gallons per inch of diameter per mile of pipe per day when the Secretary approves the reduction based on a request and specific information provided by a designer in the application.

**Table 8-1
Design Flows for the Residential Use of Buildings or Structures
With 5 or More Living Units**

Number of Living Units	Wastewater System (Gallons Per Day)	Potable Water Supply (Gallons Per Day)
5	1575	1800
6	1830	2160
7	2065	2520
8	2280	2880

Number of Living Units	Wastewater System (Gallons Per Day)	Potable Water Supply (Gallons Per Day)
9	2565	3240
10	2800	3600
11	3036	3960
12	3264	4320
13	3484	4680
14	3696	5040
15	3900	5400
16	4112	5760
17	4369	6120
18	4518	6480
19	4712	6840
20 or more	245 per living unit*	360 per living unit

* Provided the individual component of the wastewater system is receiving less than 50,000 gallons per day. When the component is receiving 50,000 gallons per day or more, the design flow for the component decreases to 210 per day per living unit.

**Table 8-2
Design Flows for Campsites**

<i>Use of Campsite</i>		
Type or description of campsite use	Units	Gallons Per Day Per Unit
<i>Campsites for Tents and Other Camping Units with No Interior Plumbing</i>		
central toilets with showers	site	75
central toilets without showers	site	50
<i>Campsites for Camping Units with Interior Plumbing but No Sewer Hook-Up</i>		
central toilets facilities	site	50
dumping station	site	25
<i>Campsites for Camping Units with Sewer Hook-Up</i>		
with or without central toilet facilities serving the units	site	75
<i>Cabins with Plumbing; Park Model Recreational Vehicles</i>		

<i>Use of Campsite</i>		
Type or description of campsite use	Units	Gallons Per Day Per Unit
with or without kitchen but without laundry facilities	sleeping space*	50
with or without kitchen but with laundry facilities	sleeping space*	70

* Design flow shall be calculated based on a minimum of four sleeping spaces.

**Table 8-3
Design Flows for Non-Residential Uses of Buildings or Structures**

<i>Use of Building or Structure</i>		
Details of use	Units	Gallons Per Day (gpd) Per Unit*
<i>Animal, Dog, or Small Animal Grooming; Kennels</i>		
for each use	employee	13
grooming station	station	400
kennels cages or enclosures	cage or enclosure	25
<i>Airport</i>		
airport	passenger	4
with restaurant licensed by the Department of Health	seat licensed by the Department of Health	use <i>Restaurant</i>
<i>Assembly Area; Conference Room with no food service</i>		
for each use	seat	4
<i>Assembly Area; Banquet Hall; Conference Room with catered food service prepared off the lot</i>		
for each use	seat per meal	8
<i>Assembly Area; Banquet Hall; Conference Room with food service for one meal (food prepared in a kitchen on the lot) (if more than one meal is served, use Restaurant)</i>		
for each use	seat	14

<i>Use of Building or Structure</i>		
Details of use	Units	Gallons Per Day (gpd) Per Unit*
<i>Barber Shop; Hair Salon</i>		
no hair washing	chair	50
hair washing	chair	150
hair salon	stylist, operator	32
barber shop; hair salon	employee (not a barber, stylist or operator)	13
<i>Beer, Wine, or Spirits Tasting Room</i>		
no public toilets, may have seats but no meal served	tasting room	100
no public toilets, may have seats but no meal served	employee	13
with public toilets and seats but no meal served	tasting room	300
with public toilets and seats if meal served	seat licensed by the Department of Health	use <i>Restaurant</i> or 300, whichever is greater
<i>Brewery</i>		
brewery	gallon of beer brewed	4.5
brewery	employee	13

<i>Bowling Alley</i>		
bowling alley	lane	67
restaurant	seat licensed by the Department of Health	use <i>Restaurant</i>
<i>Car Wash</i>		
car wash	car	based on the manufacturer's specifications for per vehicle wash
with employees	employee	13
providing public toilets	patron	4
<i>Care Facilities</i>		
correctional facility	sleeping space	125
assisted living facility	sleeping space licensed by the Agency of Human Services	85
hospitals	sleeping space	250
nursing care home	sleeping space	125
residential care homes or disabled housing	bedroom	105
rehabilitation or therapeutic community residence and shelters	sleeping space licensed by the Agency of Human Services	70
rehabilitation or therapeutic community residence and shelters	non-resident staff per shift	13
other care facilities	sleeping space	125
<i>Catering or Take-Out Facility (no on-premise public seating)</i>		
limited operation – serving coffee, steamed or roto-grilled frankfurters	N/A	0
commercial catering within a residence	N/A	100
commercial catering within a residence	employee	13
commercial caterer not in a residence	N/A	100
commercial catering not in a residence	employee	13

ice cream shop	N/A	100
ice cream shop	employee	13
bakery	N/A	100
bakery	employee	13
	N/A	100
deli	employee	13
with seafood license	N/A	100**
with seafood license	employee	13**
<i>Child Care Facility</i>		
without meals	child, employee	13
with 1 meal	child, employee	16
with 2 meals	child, employee	19
<i>Children's Summer Camp</i>		
overnight camp	person	45
day camp (no meals served)	person	13
day camp (meals served)	person	use <i>Child Care Facility</i>
<i>Church; Temples; Mosques; Other Places of Worship</i>		
sanctuary	seat	1
other areas of assembly	seat	4
meals prepared off site	seat per meal	8
<i>Dentist Office</i>		
dentist office	dentist, hygienist, other medical employee	32
dentist office	non-medical employee	13
dentist office	chair	based on manufacturer's specifications; if no specifications, 100
dentist office	patient	4, unless using 100 gallons or more per chair (then 0)
<i>Doctor Office</i>		
doctor office	doctor, nurse, other medical employee	32
doctor office	non-medical employee	13
doctor office	patient	4

<i>Food Markets; Grocery Stores; Food Stores</i>		
with bakery	N/A	100
with deli	N/A	100
with meat department but without garbage grinder	100 square feet	7.5
with meat department with garbage grinder	100 square feet	11
with seafood license	N/A	100**
with public seating	seat licensed by the Department of Health	15
<i>Hotels; Motels; Inns; Bed & Breakfasts; Extended Stay Hotels</i>		
for each use	sleeping space	50
meals served only to guests	meal per sleeping space	5
kitchen in room	sleeping space	5
staff, manager, or owner bedroom	bedroom	140
on premise laundry	machine	use <i>Laundromat; Laundry Services</i>
<i>Laundromat; Laundry Services</i>		
laundromat or laundry service	top or front-loading machine	450
laundromat or laundry service	machine	case by case based on type of operation, hours of operation, and manufacturer's specifications
laundromat or laundry service	employee	13
<i>Marina</i>		
with no showers	slip, mooring	4
with showers	slip, mooring	10
holding tank pump-out	boat	25 with a minimum size on-shore holding tank of 500 gallons
marina	employee	13

<i>Nail Salon</i>		
nail salon	manicurist or pedicurist	32
nail salon	employee (non-manicurist or pedicurist)	13
nail salon	manicure station	50
nail salon	pedicure station	100
<i>Office, Factory, Welcome Center, and Place of Employment</i>		
without showers	employee per shift	15
with showers	employee per shift	20
with cafeteria	seat	use <i>Restaurant</i>
with public toilet	patron or client (non-employee)	4
<i>Restaurant</i>		
restaurant serving a max. of 2 meals per day	seat licensed by the Department of Health	27
restaurant serving a max. of 3 meals per day	seat licensed by the Department of Health	40
restaurant with 9 or fewer seats	restaurant	300
<i>School</i>		
boarding; includes dormitories with staff, cafeterias, and showers	student	90
grades pre-school through 8 w/o cafeterias or showers	student, employee	5
grades 9 through 12 w/o cafeterias or showers	student, employee	12
grades pre-school through 8 with cafeteria and w/o showers	student, employee	8
grades 9 through 12 with cafeteria and w/o showers	student, employee	15
grades pre-school through 8 with cafeteria and showers	student, employee	11
grades 9 through 12 with cafeteria and showers	student, employee	18

<i>Service Station</i>		
service station	employee per shift	13
with public toilets	gas or diesel fueling hose	125
<i>Sports Arena; Skating Rink; Soccer Field; Tennis Court; Pools; Hot Tubs; Saunas; Spas; Health Club; Exercise Gym; Dance Studio; Similar Facility</i>		
for each use	trainer	32
for each use	employee (non-trainer)	13
for each use	spectator	3
without showers	participant	4
with showers	participant	8
restaurant or cafeteria	seat licensed by the Department of Health	15
water treatment backwash	case by case	case by case based on quantity of backwash per cycle and frequency of cycle
rink, pool, spa discharge	case by case	case by case based on the quantity of discharge and frequency of discharge
<i>Store not otherwise identified in this Table</i>		
store in a shopping center, mall, or on an individual lot	varies	4 gpd/100 sq. ft. or 90 gpd/store, whichever is greater
<i>Therapist Office (massage, physical therapy, acupuncturist, chiropractor)</i>		
therapist office	therapist	32
therapist office	employee (non-therapist)	13
without showers	client	4
with showers	client	8
<i>Therapist Office (mental health counseling)</i>		
therapist office	therapist, employee	13
therapist office	client	4
<i>Toilet Buildings associated with Outside Activities such as Picnic Areas and Recreational Fields</i>		

toilet and handwashing	person	3
showers, toilet, and handwashing	person	8
<i>Theatre</i>		
drive-in	car space	3
indoor	seat	3
with food concession	concession area	100
<i>Veterinary Clinic</i>		
veterinary clinic	veterinarian	200
veterinary clinic	employee (non-veterinarian)	13
with animal boarding	animal	25

* Design flows for each use take into account the water use of employees and toilets available to the public, unless separately addressed for a use.

** Design flow does not include disposal of ice used for storing and displaying seafood. If the ice is disposed of by spraying with water to melt the ice, the design flow needs to include the quantity of water needed to melt the ice.

Note: A use identified in Table 8-3 may generate high strength wastewater. Examples include restaurant use, convenience store use particularly with coffee sale, bar use, and coffee and donut shop use.

§ 1-804 Water Meter Data

- (a) An applicant or prospective applicant may submit a written request prepared by a designer that the Secretary determine that the wastewater strength and quantity of water necessary for a proposed non-residential use of a building or structure does not require the design flows specified in Table 8-3 for individual components of a soil-based wastewater system or of a sanitary sewer service line that conveys wastewater to an indirect discharge system, for individual components of a potable water supply, and for the replacement area, and that the Secretary assign a design flow for the use based on the following factors:
- (1) the nature and design of the proposed use, including equipment that may be part of the use and any manufacturing process;
 - (2) daily water use data, as further described in Subsection (c);
 - (3) daily wastewater discharge collected and recorded using a method approved by the Secretary prior to collection;
 - (4) seasonal variations known or anticipated in occupancy or water usage of the building or structure;
 - (5) wastewater strength and characteristics analysis data, including BOD and TSS, that may be required to adjust the sizing of the leachfield according to § 1-904, as further described in Subsection (e); and

- (6) other information the Secretary deems necessary based on the specific proposed use and request.
- (b) An applicant or prospective applicant may submit a written request prepared by a designer that the Secretary determine that the quantity of water necessary for a proposed non-residential use of a building or structure does not require the design flows specified in Table 8-3 for individual components of a sanitary sewer service line that conveys wastewater to a wastewater treatment facility and individual components of a potable water supply and that the Secretary assign a design flow for the use based on the following factors:
- (1) the nature and design of the proposed use, including equipment that may be part of the use and any manufacturing process;
 - (2) daily water use data, as further described in Subsection (c);
 - (3) daily wastewater discharge collected and recorded using a method approved by the Secretary prior to collection;
 - (4) seasonal variations known or anticipated in occupancy or water usage of the building or structure; and
 - (5) other information the Secretary deems necessary based on the specific proposed use and request.
- (c) The burden shall be on the applicant or prospective applicant requesting the determination pursuant to Subsection (a) or (b) to satisfy the following requirements with information from a designer:
- (1) Propose a design flow for the wastewater system based on:
 - (A) the 90th percentile of all daily water meter readings; and
 - (B) a proposed safety factor that accounts for fluctuations in metered flows. Considerations for determining a safety factor include:
 - (i) the number of days the water meter readings exceeds the average flow calculated based on the water meter readings for the year;
 - (ii) the number of days the water meter readings exceed the average flow calculated based on the water meter readings during the 3 consecutive months representing the highest water usage; and
 - (iii) the 90th percentile of the water meter readings representing the highest water usage for 3 consecutive months.
 - (2) Propose a design flow for the potable water supply based on the peak recorded daily water meter reading.
 - (3) Demonstrate that the wastewater system and potable water supply comply with technical standards in this Subchapter and Subchapters 9, 10, 11, and 12;
 - (4) Provide information that addresses each factor in Subsection (a) or (b) and enables the Secretary to reach a determination and assign a design flow.
- (d) Water use data shall include the following:
- (1) A minimum of daily water meter readings for a year, unless:
 - (A) the wastewater system and potable water supply will be operated for less than 180 days of days, in which case, daily water meter readings shall be taken for each day in operation; or

- (B) the wastewater system and potable water supply will be operated for 180 days or more and the Secretary concludes that 1 year of daily water meter readings is not necessary to demonstrate the wastewater strength and quantity of water necessary for the proposed use and the Secretary provides approval, prior to the collection of water meter readings, for daily water meter readings to be taken for 180 consecutive days. An applicant seeking such approval shall submit the following information:
 - (i) the nature the existing use of the building or structure, including equipment that may be part of the use and any manufacturing process, that will be in use when meter readings will not be taken;
 - (ii) seasonal variations in occupancy or water usage of the building or structure demonstrating that all variations will be recorded during the 180 days;
 - (iii) wastewater strength and characteristics, including BOD and TSS, that may be required to adjust the sizing of the leachfield according to § 1-904 and as further described in Subsection (e), for the days when meter readings will not be taken; and
 - (iv) other information the Secretary deems necessary based on the specific proposed use and request.
- (2) Daily record of the number of occupants, employees, or other users of the building or structure, unless approval is provided by the Secretary, prior to collection of water meter readings and based in information submitted by the applicant, of an alternative basis for recording the intensity of the daily use of the building or structure.
- (3) The quantity of process water used for industrial or manufacturing facilities.
- (4) The quantity of water for domestic type use.
- (5) The quantity of water that comes from the potable water supply serving the building or structure that will not discharge to the wastewater system.
- (e) Wastewater strength and characteristics analysis data shall include 8-hour composite samples or other sampling method approved by the Secretary during the period of recording the water meter readings, taken at the following intervals:
 - (1) 1 sample during each 3-month period of use of the building or structure, provided that, if the building or structure is in use for fewer than 6 months, a minimum of 2 samples are taken;
 - (2) at least 2 of the samples shall be taken during the normal peak use of the building or structure or campground; and
 - (3) more frequent sampling when the Secretary determines that the sampling results may not be representative of the use of the building or structure.
- (f) The approval by the Secretary of a design flow different than that specified in Table 8-3 shall not be used for the purposes of determining, pursuant to § 1-301(a), whether an action will result in an increase in design flow of any component of a wastewater system or potable water supply.
- (g) The approval by the Secretary of a design flow different than that specified in Table 8-3 for a proposed non-residential use of a building or structure shall:

- (1) be issued in writing in the permit for the wastewater system or potable water supply that will serve the building or structure; and
- (2) state that a reduction from the design flow specified in Table 8-3 was approved and identify the approved design flow.

§ 1-805 Wastewater Strength

- (a) A leachfield for which design flow is determined pursuant to § 1-803(f)(2) or (3) or that will dispose of food processing waste, including a leachfield that will serve a building or structure with a use as a brewery, shall comply with the following requirements:
 - (1) Septic tank effluent that is low strength may be discharged to the leachfield.
 - (2) Septic tank effluent that is high strength but treated to reduce the strength to low strength may be discharged to the leachfield after such treatment.
 - (3) Septic tank effluent that is high strength is prohibited from being discharged to the leachfield unless the leachfield is sized pursuant to Subsection (d).
- (b) Wastewater strength of septic tank effluent shall be categorized based on the following standards:
 - (1) Septic tank effluent is low strength when it meets the following standards:
 - (A) $BOD_5 \leq 300$ mg/L;
 - (B) $TSS \leq 150$ mg/L; and
 - (C) Fats, Oil & Grease (FOG) ≤ 50 mg/L.
 - (2) Septic tank effluent that exceeds any one of the standards for BOD_5 , TSS, or FOG specified in Subsection (b)(1) is high strength.
- (c) When wastewater strength is determined for septic tank effluent, it shall be determined using one of the following methods:
 - (1) sampling of BOD_5 , TSS, and Fats, Oil, & Grease as an 8-hour composite or other sampling method approved by the Secretary;
 - (2) sampling of BOD_5 , TSS, and Fats, Oil, & Grease from a wastewater system serving buildings or structures or campground with similar uses as an 8-hour composite or other sampling method approved by the Secretary; or
 - (3) literature review of BOD_5 , TSS, and Fats, Oil, & Grease from buildings or structures, or campgrounds with similar uses, using the highest strength value identified for the particular uses.
- (d) When a leachfield is proposed to dispose of high strength wastewater and is proposed using a Secretary-assigned design flow based on the submission of water use data and wastewater strength calculations pursuant to § 1-803(f)(3)(A) or § 1-804, the leachfield shall be sized using one of the following formulas in lieu of any formula or method for sizing the particular type of leachfield specified in Subchapter 9 that would otherwise apply:
 - (1) The formula $SQLF = (BOD_5 \div 300 \text{ mg/L}) \times (DF \div AR)$ where:
 - (A) $SQLF$ = the minimum required square footage of leachfield in square feet;
 - (B) DF = the design flow in gallons per day; and
 - (C) AR = the application rate for the soil in gallons per square foot per day identified in § 1-911.

- (2) Another formula proposed by an applicant's designer and accepted by the Secretary.

§ 1-806 Determining Baseline Design Flow for Increases in Design Flow

- (a) For the purpose of this Section, the term "bedroom" means:
 - (1) a room identified as a bedroom on a lister card applicable between January 1, 2006 and December 31, 2006; or
 - (2) a room the owner of the building or structure between January 1, 2006 and December 31, 2006 certifies under oath was:
 - (A) occupied as sleeping quarters for a minimum of 90 days between January 1, 2006 and December 31, 2006; and
 - (B) contained one window or door that leads directly to the outside and one door that separates the room from the other living space.
- (b) For the purpose of determining, pursuant to § 1-301(a), whether an action will result in an increase in design flow of any component of a wastewater system or potable water supply for which the clean slate permit exemption in § 1-303 is in effect, the baseline design flow from which a potential increase is measured shall be calculated according to the following:
 - (1) For living units:
 - (A) The maximum number of bedrooms in the living unit between January 1, 2006 and December 31, 2006, and the following standards:
 - (i) that the first 3 bedrooms in a living unit contains 2 persons per bedroom, unless Subsection (B) or (C) applies;
 - (ii) that each additional bedroom beyond 3 contains 1 person per bedroom, unless Subsection (B) or (C) applies; and
 - (iii) that each person uses 70 gallons of water per day.
 - (B) If a bedroom contains built-in beds providing sleeping space for more than 2 persons, the number of persons assumed for that bedroom shall be based on the number of sleeping spaces.
 - (C) If an applicant certifies under oath that more than 2 persons were living in a bedroom at the same time between January 1, 2006 and December 31, 2006, the number of persons assumed for that bedroom shall be based on the number certified to.
 - (2) For campsites, the maximum number and the use of campsites that existed between January 1, 2006 and December 31, 2006, and the design flow specified in Table 8-2.
 - (3) For buildings or structures or portions of building or structure other than living units, the use, or combination of uses in a 24-hour period, of the building or structure between January 1, 2006 and December 31, 2006 with the highest design flow, and the design flow specified in Table 8-3.
- (c) For the purpose of determining, pursuant to § 1-301(a), whether an action will result in an increase in design flow of any component of a wastewater system or potable water supply for which the clean slate permit exemption in § 1-303 is not in effect, the baseline design flow from which a potential increase is measured shall be calculated by reference to the

permit authorizing the operation of the component, the approved site plan, and the design flows specified in § 1-803.

- (d) A baseline design flow shall not be calculated using a Secretary approved design flow authorized pursuant to § 1-804 except pursuant to § 1-803(f)(3) for uses not appearing in Table 8-3.

Subchapter 9 – Specific Technical Standards for Wastewater Systems

§ 1-901 Use of Term Wastewater System

Except as used in § 1-928, the term wastewater system as used in this Subchapter shall mean soil-based wastewater system.

§ 1-902 Replacement Area

- (a) All existing and proposed wastewater systems on a lot on which one or more of the following actions is proposed in an application shall have designated replacement areas:
- (1) the construction of a new building or structure or the creation of a campground;
 - (2) an increase in the design flow of the leachfield;
 - (3) the subdivision of the lot; or
 - (4) the construction of a wastewater system that is an innovative/alternative system with experimental approval.
- (b) Notwithstanding Subsection (a), a replacement area is not necessary for a wastewater system in any of the following circumstances:
- (1) The wastewater system:
 - (A) includes a leachfield or combination of leachfields sized to dispose of 150 percent or more of the design flow;
 - (B) is designed to use pressure distribution; and
 - (C) meets the other technical standards in this Subchapter and Subchapters 8 and 10.
 - (2) The wastewater system includes a mound that:
 - (A) includes a leachfield or combination of leachfields sized to dispose of 100 percent or more of the design flow; and
 - (B) meets the other technical standards in the September 10, 1982 version of these Rules, or a later version.
 - (3) The wastewater system includes a bottomless sand filter that:
 - (A) includes a leachfield or combination of leachfields sized to dispose of 100 percent or more of the design flow;
 - (B) a hydrogeological analysis which demonstrates a minimum of 12 inches of unsaturated naturally occurring soil exists beneath the bottomless sand filter fill material to the induced water table; and
 - (C) meets the other technical standards in this Subchapter and Subchapters 8 and 10.
- (c) A wastewater system that is required to have a designated replacement area can alternatively have a designated replacement system in lieu of the replacement area.
- (d) A replacement area shall be an area that is able to comply with:
- (1) the technical standards in this Subchapter to support the type of leachfield, required naturally occurring soil around the perimeter of the leachfield, and fill material for the particular type of leachfield that is intended to be placed in the replacement area;

- (2) if the wastewater system to be replaced is an innovative/alternative system with general use approval or pilot approval pursuant to Subchapter 4, the requirements of the approval to support a leachfield of the same type to be placed in the replacement area; or
- (3) if the wastewater system to be replaced is an innovative/alternative system with experimental approval, the technical standards in this Subchapter to support a type of leachfield, required naturally occurring soil around the perimeter of the leachfield, and fill material for a leachfield that complies with the technical standards in this Subchapter to be placed in the replacement area.

§ 1-903 General Requirements for Soil-Based Wastewater Systems

- (a) Except where otherwise specified in these Rules, a wastewater system shall include a leachfield, or combination of leachfields, that are sized to dispose of at least 100 percent of the design flow and that comply with all other technical standards in this Subchapter.
 - (1) The leachfields shall be in-ground leachfields, at-grade leachfields, leachfields in mounds, or leachfields in bottomless sand filters that comply with the technical standards in this Subchapter.
 - (2) Cesspools and dry wells (i.e., seepage pits) are prohibited from inclusion in a wastewater system.
- (b) A wastewater system shall include a septic tank that complies with § 1-908 unless this requirement is waived by the Secretary following determination by the Secretary that a septic tank is unnecessary for the separation of grease, scum, and solids associated with the wastewater, based on information provided by an applicant's or prospective applicant's designer.
- (c) When a hydrogeological analysis is performed to demonstrate compliance with a requirement in these Rules, the minimum length of the leachfield shall be the length determined from the hydrogeological analysis if this length is greater than that the minimum length required for the particular type of leachfield found in other provisions of these Rules.
- (d) Ground slope requirements for leachfields
 - (1) The average ground slope of the naturally occurring soil across the entire width and length of the area where an in-ground leachfield is proposed to be constructed, or where the limits of the mound fill material for a leachfield to be constructed in a mound is proposed, or where the infiltrative surface for an at-grade leachfield is proposed to be constructed, shall not exceed 20 percent.
 - (2) When the design of an in-ground leachfield is less than 10 feet in width or length, the average slope shall not exceed 20 percent in the area measured beginning at the upslope edge of the trench or bed and continuing 10 feet horizontal distance in the downslope direction.
 - (3) Notwithstanding Subsections (d)(1) and (2), when the lot on which the building or structure or campground to be served by a proposed wastewater system was created before June 14, 2002:
 - (A) the average ground slope of the naturally occurring soil across the entire width and length of the area where an in-ground leachfield is proposed to

- be constructed, or where the limits of the mound fill material for a leachfield to be constructed in a mound is proposed, or where the infiltrative surface for an at-grade leachfield is proposed to be constructed, shall not exceed 30 percent; and
- (B) when the design of an in-ground leachfield is less than 10 feet in width or length, the average slope shall not exceed 30 percent in the area measured beginning at the upslope edge of the trench or bed and continuing 10 feet horizontal distance in the downslope direction.
- (4) The average ground slope of the naturally occurring soil across the entire width and length of the area where a bottomless sand filter is proposed to be constructed shall not exceed 5 percent.
- (5) When the average ground slope of the naturally occurring soil across the entire width and length of the area where an in-ground leachfield is proposed to be constructed, or where the limits of the mound fill material for a leachfield to be constructed in a mound is proposed, or where the infiltrative surface for an at-grade leachfield is proposed to be constructed, exceeds 20 percent, the design shall include the following:
- (A) Methods for site stability in the area of the leachfield before, during, and after construction with specific attention to erosion prevention and sediment control.
- (B) Specifications for:
- (i) construction of the wastewater system;
 - (ii) stormwater diversions if needed to prevent stormwater from eroding soil in the area of the leachfield; and
 - (iii) re-vegetation to prevent soil erosion.
- (6) The long dimension of distribution piping in a leachfield shall be laid parallel to the ground slope or contours.
- (7) No leachfield shall be constructed in an area where the ground slope or contours create a depression that will act as a natural surface or groundwater collection area.
- (e) No portion of a wastewater system, except a sanitary sewer service line or sanitary sewer collection line, shall be located in a floodway.
- (f) A wastewater system shall be located, designed, and constructed in a manner that avoids impairment to the system and contamination from the system during flooding if the site is located in a mapped flood hazard area.
- (g) No portion of a wastewater system shall be located in a Zone 1 of a Public Community Water System Source Protection Area, except a replacement system that replaces an existing wastewater system located in the same Zone 1.
- (h) For wastewater systems located in a watershed that drains into a water classified as Class A in the Vermont Water Quality Standards, except a replacement system that is not proposed in lieu of a replacement area in the same application as the wastewater system it would replace, the following requirements apply:
- (1) No wastewater system with a design flow that exceeds 1000 gallons per day shall be approved.

- (2) The maximum cumulative design flow for multiple wastewater systems on the same lot shall not exceed 1000 gallons.
- (i) The following are the required depths of naturally occurring soil for in-ground leachfields and at-grade leachfields.
 - (1) Except where Subsection (i)(2) applies and where otherwise specified in these Rules, the minimum depth of naturally occurring soil below the bottom of the leachfield stone or other infiltrative surface of the leachfield shall be:
 - (A) 36 inches to the seasonal high-water table;
 - (B) 36 inches to a soil with a texture of silt loam, silt, sandy clay loam, clay loam, silty clay loam, sandy clay, silty clay, or clay;
 - (C) 36 inches to a soil with a consistence of firm or denser regardless of texture;
 - (D) 48 inches to bedrock; and
 - (E) for a leachfield disposing of 2000 gallons or more per day of effluent, 36 inches to the induced water table, as demonstrated through a hydrogeological analysis.
 - (2) When the leachfield disposes of filtrate effluent and is designed in accordance with § 1-904(a), the minimum depth of naturally occurring soil below the bottom of the leachfield stone or other infiltrative surface of the leachfield shall be:
 - (A) 18 inches to a soil with a texture of sandy clay, silty clay, or clay;
 - (B) 18 inches to a soil with a consistence of firm or denser, regardless of texture;
 - (C) 24 inches to bedrock; and
 - (D) 18 inches to the induced water table, as demonstrated through a hydrogeological analysis.
 - (3) For in-ground leachfields, the minimum depths of naturally occurring soil shall be met for a distance of 10 feet beyond the edge of the leachfield stone or other infiltrative surface.
 - (4) For at-grade leachfields, the minimum soil depths of naturally occurring soil shall be met for a distance of:
 - (A) 25 feet beyond the limits of the fill material in the downslope direction; and
 - (B) 10 feet beyond the limits of the fill material on all other sides.
- (j) The following are the required depths of naturally occurring soil and fill material for a leachfield in a mound.
 - (1) The minimum depth of naturally occurring soil below ground surface to site the leachfield, shall be:
 - (A) 24 inches to the seasonal high-water table;
 - (B) 24 inches to a soil with a texture of sandy clay, silty clay, or clay;
 - (C) 24 inches to a soil with a consistence of firm or denser, regardless of texture; and
 - (D) 24 inches to bedrock.
 - (2) The minimum depths of naturally occurring soil shall be met:
 - (A) for a distance of 25 feet beyond the limits of the fill material of the mound in the downslope direction;

- (B) for a distance of 10 feet beyond the limits of the fill material at each end of the mound; and
 - (C) at the limits of the fill material of the mound in the upslope direction.
 - (3) The depth of mound fill material below the bottom of the leachfield stone or other infiltrative surface of the leachfield shall be sufficient to obtain the following vertical separations:
 - (A) 36 inches to the seasonal high-water table;
 - (B) 36 inches to a soil with a texture of sandy clay, silty clay, or clay; and
 - (C) 48 inches to bedrock.
 - (4) The minimum depth of mound fill material between the bottom of the leachfield stone or other infiltrative surface of the leachfield and ground surface shall be 12 inches.

- (k) Notwithstanding Subsection (j), the following are the required depths of naturally occurring soil and mound fill material for a leachfield in a mound when a hydrogeological analysis is performed.
 - (1) The minimum depth of naturally occurring soil below ground surface to site the leachfield shall be 18 inches to bedrock.
 - (2) The minimum depth of naturally occurring soil beneath the mound fill material to site the leachfield shall be:
 - (A) 6 inches to the induced water table, as demonstrated through a hydrogeological analysis; or
 - (B) 6 inches to the induced water table at the limits of the fill material, as demonstrated through a hydrogeological analysis completed through a method identified in Subsection (r)(1)(B) or (C), regardless of whether the induced water table rises to less than 6 inches beneath the mound fill material or rises into the mound fill material beneath the leachfield.
 - (3) The minimum depths of naturally occurring soil shall be met:
 - (A) for a distance of 25 feet beyond the limits of the fill material of the mound in the downslope direction; and
 - (B) for a distance of 10 feet beyond the limits of the fill material of the mound at each end of the mound; and
 - (C) at the limits of the fill material of the mound in the upslope direction.
 - (4) The depth of mound fill material below the bottom of the leachfield stone or other infiltrative surface of the leachfield shall be sufficient to obtain the following vertical separations:
 - (A) 36 inches to the induced water table, as demonstrated through a hydrogeological analysis;
 - (B) 36 inches to a soil with a texture of sandy clay, silty clay, or clay; and
 - (C) 48 inches to bedrock.
 - (5) The minimum depth of mound fill material between the bottom of the leachfield stone or other infiltrative surface of the leachfield and ground surface shall be 12 inches.

- (l) Notwithstanding Subsection (j), the following are the required depths of naturally occurring soil and mound fill material for a leachfield in a mound that disposes of filtrate effluent and is designed in accordance with § 1-904(a).

- (1) The minimum depth of naturally occurring soil below ground surface to site the leachfield shall be 18 inches to bedrock.
 - (2) The minimum depth of naturally occurring soil beneath the mound fill material to site the leachfield shall be:
 - (A) 6 inches to the induced water table, as demonstrated through a hydrogeological analysis; or
 - (B) 6 inches to the induced water table at the limits of the mound fill material, as demonstrated through a hydrogeological analysis completed through a method identified in Subsection (r)(1)(B) or (C), regardless of whether the induced water table rises to less than 6 inches beneath the fill material or rises into the mound fill material beneath the leachfield.
 - (3) The minimum depths of naturally occurring soil shall be met:
 - (A) for a distance of 25 feet beyond the limits of the fill material of the mound in the downslope direction;
 - (B) for a distance of 10 feet beyond the limits of the fill material of the mound at each end of the mound; and
 - (C) at the limits of the fill material of the mound in the upslope direction.
 - (4) The depth of mound fill material below the bottom of the leachfield stone or other infiltrative surface of the leachfield shall be sufficient to obtain the following vertical separations:
 - (A) 18 inches to the induced water table, as demonstrated through a hydrogeological analysis;
 - (B) 18 inches to a soil with a texture of sandy clay, silty clay, or clay; and
 - (C) 24 inches to bedrock.
 - (5) The minimum depth of mound fill material between the bottom of the leachfield stone or other infiltrative surface of the leachfield and ground surface shall be 12 inches.
- (m) The following are the required depths of naturally occurring soil and bottomless sand filter fill material for a leachfield in a bottomless sand filter.
- (1) The minimum depth of naturally occurring soil below ground surface to site the leachfield shall be:
 - (A) 24 inches to a soil with a texture of silt loam, silt, sandy clay loam, clay loam, silty clay loam, sandy clay, silty clay, or clay;
 - (B) 24 inches to a soil with a consistence of firm or denser, regardless of texture; and
 - (C) 24 inches to bedrock.
 - (2) The minimum depth of naturally occurring soil beneath the bottom of the enclosure to site the leachfield shall be 6 inches to the induced water table, as demonstrated through a hydrogeological analysis.
 - (3) The minimum depths of naturally occurring soil shall be met for a distance of:
 - (A) 25 feet from the edge of the enclosure for the bottomless sand filter in the downslope direction; and
 - (B) 10 feet from the edge of the enclosure for the bottomless sand filter on all other sides.
 - (4) Except where Subsection (m)(5) applies, the depth of bottomless sand filter fill material below the bottom of the leachfield stone or other infiltrative surface of the leachfield shall be sufficient to obtain the following vertical separations:

- (A) 36 inches to the induced water table, as demonstrated through a hydrogeological analysis;
 - (B) 36 inches to a soil with a texture of silt loam, silt, sandy clay loam, clay loam, silty clay loam, sandy clay, silty clay, or clay;
 - (C) 36 inches to a soil with a consistence of firm or denser, regardless of texture; and
 - (D) 48 inches to bedrock.
- (5) When a leachfield in a bottomless sand filter disposes of filtrate effluent and is designed in accordance with § 1-904(a), the depth of bottomless sand filter fill material below the bottom of the leachfield stone or other infiltrative surface of the leachfield shall be sufficient to obtain the following vertical separations:
- (A) 18 inches to the induced water table, as demonstrated through a hydrogeological analysis;
 - (B) 18 inches to a soil with a texture of silt loam, silt, sandy clay loam, clay loam, silty clay loam, sandy clay, silty clay, or clay;
 - (C) 18 inches to a soil with a consistence of firm or denser, regardless of texture; and
 - (D) 24 inches to bedrock.
- (6) The minimum depth of bottomless sand filter fill material between the bottom of the leachfield stone or other infiltrative surface of the leachfield and ground surface shall be 12 inches.
- (n) Except as allowed by (p) or (q) of this Subsection, a hydrogeological analysis shall be completed in each of the following circumstances:
- (1) An in-ground leachfield, or at-grade leachfield, has a design flow of 2000 gallons per day or more.
 - (2) A leachfield in a mound with a design flow of 1000 gallons per day or more.
 - (3) The leachfield is constructed in a bottomless sand filter.
 - (4) There is a potential hydraulic connection between the leachfield or replacement area and a separate leachfield or replacement area because all of the following are true:
 - (A) the leachfield or replacement area is located 25 feet or closer upslope or downslope to another leachfield or another replacement area as measured from the following points:
 - (i) for in-ground leachfields, the limits of the leachfield stone or other infiltrative surface of the leachfield;
 - (ii) for at-grade leachfields, the limits of the fill material;
 - (iii) for leachfields in mounds, the limits of the fill material for the mound; and
 - (iv) for leachfields in bottomless sand filters, the edge of the enclosure.
 - (B) the downslope leachfield is located partially or entirely in the same flow path of the upslope leachfield as determined by ground slope or groundwater flow; and
 - (C) one of the following exist:
 - (i) the combined design flow for an in-ground leachfield, or at-grade leachfield, and any upslope leachfield is 2000 gallons per day or more;

- (ii) the combined design flow for a leachfield in a mound and any upslope leachfield is 1000 gallons per day or more;
 - (iii) the downslope leachfield is in a bottomless sand filter; or
 - (iv) the downslope leachfield is unable to comply with the depth of naturally occurring soil required pursuant to this Section, regardless of the design flow of the proposed leachfield.

- (o) The hydrogeological analysis required pursuant to Subsection (n) shall demonstrate that:
 - (1) the leachfield will maintain the depths of naturally occurring soil and fill material for the leachfield required by this Section; and
 - (2) any leachfield located downslope of a proposed wastewater system or replacement area will maintain the depths of naturally occurring soil and fill material for the leachfield required by this Section; or
 - (3) if the downslope leachfield is unable to comply with the depth of naturally occurring soil required pursuant to this Section, the induced water table does not rise closer to the bottom of the leachfield.

- (p) The Secretary may waive the hydrogeological analysis required pursuant to Subsection (n)(1) or (4) when an applicant or prospective applicant requests a waiver and provides information from a designer demonstrating that any hydraulic interference will not reduce the depths of naturally occurring soil and fill material for each leachfield to less than that required by this Section.

- (q) The Secretary may waive the hydrogeological analysis required under Subsection (n)(2), when an applicant or prospective applicant requests a waiver and provides information from a designer demonstrating that:
 - (1) the leachfield will dispose of filtrate effluent and is designed in accordance with § 1-904(a);
 - (2) the leachfield will be designed using a linear loading rate not exceeding 4.5 gallons per day per linear foot;
 - (3) there is a minimum of 24 inches of naturally occurring soil below ground surface to the seasonal high-water table, impermeable soil layer, and bedrock; and
 - (4) the limits of the fill material for the mound will be a minimum of 25 feet to an in-ground leachfield, a leachfield in a mound, and a leachfield in a bottomless sand filter.

- (r) When a hydrogeological analysis is performed to demonstrate compliance with a requirement in these Rules, the hydrogeological analysis shall:
 - (1) Be completed through one of following methods:
 - (A) the simplified method described in § 1-927, performed by a hydrogeologist or a designer authorized to design the wastewater system for which the hydrogeological analysis is performed, provided the soil does not have a consistence of firm or denser and the leachfield is one of the following:
 - (i) an in-ground leachfield or at-grade leachfield with a design flow of less than 2000 gallons per day;
 - (ii) a leachfield in a mound with a design flow of less than 1000 gallons per day; or

- (iii) a leachfield in a bottomless sand filter with a design flow of less than 1000 gallons per day;
 - (B) a method, performed by a hydrogeologist, approved by the Secretary based on using site specific soil descriptions and conservative hydraulic conductive assumptions; or
 - (C) a method, performed by a hydrogeologist, approved by the Secretary based on site specific hydraulic conductivity testing.
 - (2) Determine the minimum length of the leachfield based on the height of the induced water table.
- (s) When a 2-year time of travel is calculated to demonstrate compliance with a requirement in these Rules, the 2-year time of travel shall be determined by:
- (1) a hydrogeologist; and
 - (2) taking into consideration:
 - (A) the hydraulic gradient;
 - (B) porosity; and
 - (C) the saturated hydraulic conductivities in the materials with the largest saturated hydraulic conductivity.
- (t) The distances over which naturally occurring soil is required to be met pursuant to § 1-903(i), (j), (k), (l), and (m) may overlap for different wastewater systems, but no portions of a wastewater system shall be located within the distance over which naturally occurring soil is required for a different wastewater system.
- (u) When a wastewater system is designed to dispose only of food processing waste that does not contain pathogens and of wastewater from hand-washing fixtures located in the food processing area, the leachfield shall comply with the minimum depths of naturally occurring soil and fill material identified in Subsections (i)(2), (l), (m)(5) that are otherwise reserved only for leachfields that dispose of filtrate effluent designed in accordance with § 1-904(a).

§ 1-904 Filtrate Effluent

- (a) Wastewater systems designed to dispose of filtrate effluent shall:
 - (1) be designed using pressure distribution pursuant to § 1-914; and
 - (2) comply with all other technical standards in this Subchapter, except that a wastewater system designed to dispose of filtrate effluent may use up to twice the application rate of soil for sizing the leachfield required by § 1-911.
- (b) A Class 1, Class B, or Class BW designer is required to submit the installation certification for the installation of a wastewater system designed to dispose of filtrate effluent.

§ 1-905 Water Table Monitoring

- (a) Except for a leachfield designed in a mound using a curtain drain pursuant to § 1-921(c), monitoring of the water table shall be used to establish the seasonal high-water table for a site where a curtain drain is used to lower the seasonal high-water table.

- (b) Monitoring of the water table may be used to establish the seasonal high-water table in lieu of determining the seasonal high-water table using soil evaluation pursuant to § 1-910(g).
- (c) By March 1 of the year during which monitoring of the water table is to be conducted, the prospective applicant shall submit to the Secretary a proposal for water table monitoring prepared by a designer or hydrogeologist which meets the following requirements:
 - (1) Takes into account:
 - (A) the site-specific drainage area;
 - (B) regional drainage that may affect the area being monitored;
 - (C) soil evaluation; and
 - (D) spacing of monitoring wells to sufficiently establish the water table level to site a leachfield.
 - (2) Includes the following information:
 - (A) permit number if the project has a permit application submitted to the Secretary or the project has a permit;
 - (B) site location map;
 - (C) 911 address of the property on which monitoring wells will be located;
 - (D) landowner name, phone number, and mailing address;
 - (E) signed property access form; and
 - (F) calculations for sizing the leachfield if the proposed use is known.
 - (3) Includes a site plan showing, at a minimum:
 - (A) boundary lines and dimensions for the lot;
 - (B) anticipated footprint of any proposed wastewater systems if calculated;
 - (C) locations of all monitoring wells with corresponding identification number or letter;
 - (D) location of existing diversion ditches and curtain drains;
 - (E) location and construction details for proposed diversion ditches and curtain drains to be authorized by the Secretary;
 - (F) location and results of soil test pits; and
 - (G) any other existing or proposed features that may affect the leachfield area.
 - (4) Includes a detail sheet for the design of the monitor wells including:
 - (A) depth of the bottom of each well below ground surface;
 - (B) height of each well above ground surface;
 - (C) pipe material including:
 - (i) perforation spacing; and
 - (ii) filter fabric or method to prevent clogging or siltation of the monitoring pipes. The designer may propose to the Secretary alternatives to filter fabric when the designer concludes wells will not be subject to clogging or siltation.
 - (5) Includes a monitoring schedule and plan which meets the following requirements:
 - (A) A minimum of 4 water table monitoring wells shall be installed for each leachfield and replacement area, except in the following circumstances:
 - (i) The Secretary authorizes fewer monitoring wells to determine site suitability in the following situation:
 - (I) the area to be monitored is 75 feet or less in length;
 - (II) the area to be monitored is 75 feet or less in width;

- (III) the area to be monitored is for an in-ground leachfield; and
 - (IV) soil evaluations indicate consistent soil depths to the anticipated seasonal high-water table
 - (ii) The Secretary requires additional monitoring wells to determine site suitability in the following situations:
 - (I) the length or width of the area intended for a leachfield or downslope receiving soil to be monitored exceeds 75 feet; or
 - (II) soil evaluations indicate highly varied soil depths to the anticipated seasonal high-water table.
 - (B) Monitoring shall occur between March 1 and May 31.
 - (C) Water table readings shall be taken at each well at least once every 5 days during the monitoring period by a designer or hydrogeologist.
 - (D) Each water table reading shall represent the water elevation for the 2 ½ days before and the 2 ½ days after a particular reading, or 1 ½ days if readings occur more frequently than every 5 five days.
 - (E) The recorded water table shall be based on the elevation of the ground surface at each monitoring well to the water table.
- (d) Monitoring of the water table shall be completed in conformance with the water table monitoring proposal.
 - (1) Water table monitoring may begin prior to the Secretary's approval of the proposal, but the Secretary reserves the ability to ultimately determine that some or all of the monitoring does not meet the requirements of Subsection (a).
 - (2) The Secretary may conduct site visits and record the water table on a site undergoing monitoring.
- (e) Data collected from monitoring of the water table shall be analyzed to determine the seasonal high-water table.
 - (1) The analysis shall be completed by:
 - (A) a Class 1, Class B, or Class BW designer authorized to design the wastewater system for which the analysis is being completed; or
 - (B) a hydrogeologist.
 - (2) A perched water table shall be analyzed in the same manner as any other type of water table.
 - (3) Except where Subsection (e)(4) applies, the analysis shall demonstrate that the water table did not:
 - (A) For more than 30 total days during the monitoring period, rise above the depth of naturally occurring soil required pursuant to § 1-903 to the seasonal high-water table.
 - (B) For more than 20 total days during the monitoring period, rise more than 6 inches above the depth of naturally occurring soil required pursuant to § 1-903 to the seasonal high-water table.
 - (C) For more than 10 total days during the monitoring period, rise more than 12 inches above the depth of naturally occurring soil required pursuant to § 1-903 to the seasonal high-water table.

- (D) For any day during the monitoring period, rise more than 18 inches above the depth of naturally occurring soil required pursuant to § 1-903 to the seasonal high-water table.
- (4) When a hydrogeological analysis is or will be performed for calculating the induced water table, the following requirements shall be met:
 - (A) The hydrogeological analysis:
 - (i) shall calculate the induced water table using the shallowest water level reading measured in the monitoring wells within the area for the leachfield or replacement area; or
 - (ii) if completed by a hydrogeologist, may identify the interpreted form of the induced water table within the area of the leachfield or replacement area using data acquired from each monitoring well.
 - (B) The analysis of the water level monitoring data shall demonstrate that the induced water table will not:
 - (i) For in-ground leachfields or at-grade leachfields that do not comply with the requirements of § 1-904(a), rise to less than 36 inches below the bottom of the leachfield stone or other infiltrative surface.
 - (ii) For in-ground leachfields or at-grade leachfields that dispose of filtrate effluent and are designed in accordance with § 1-904(a), rise to less than 18 inches below the bottom of the leachfield stone or other infiltrative surface.
 - (iii) For all other leachfields, rise to less than 6 inches below ground surface.
- (f) Following completion of water table monitoring, all water table monitoring data collected shall be submitted to the Secretary.
- (g) For sites on which the water table is monitored for more than 1 year, the seasonal high-water table shall be based on the year that recorded the most restrictive water table monitoring readings.
- (h) The Secretary may allow sites on which the water table was previously monitored to be re-monitored when a physical change is planned for the site that is anticipated to affect the water table.
 - (1) Examples of physical changes the Secretary will consider include the installation of a curtain drain and the installation of a groundwater diversion that did not exist during the first monitoring of the site, provided these changes have Secretary approval if required by these Rules.
 - (2) When the Secretary has allowed re-monitoring, calculation of the seasonal high-water table shall be based on water table monitoring readings taken during the year of re-monitoring and shall not take into account prior years' readings.

Note: Appendix C, Figure C-2, depicts a detail of a typical groundwater monitoring well.

§ 1-906 Site Modifications

- (a) Requirements for curtain drains.

- (1) Except for a leachfield designed in a mound pursuant to § 1-921(c), if the area in which a leachfield is proposed to be located does not comply with depth of naturally occurring soil required pursuant to § 1-903 to the seasonal high-water table, the design of a wastewater system may, in the following circumstances only, rely on curtain drains to lower the seasonal high-water table in order to comply with § 1-903:
 - (A) The Secretary has pre-authorized the installation and use of such drains pursuant to Subsection (a)(3) and monitoring of the water table has been conducted pursuant to § 1-905 to demonstrate the drain's effectiveness.
 - (B) In conjunction with an application, the Secretary approves the installation of and use of such drains, provided the following requirements are met:
 - (i) The curtain drain is designed in compliance with a plan that conforms with the requirements in Subsection (a)(2)(C).
 - (ii) The bottom of the curtain drain is designed to be a minimum of 12 inches into a soil with a texture of silt loam, silt, sandy clay loam, clay loam, silty clay loam, sandy clay, silty clay, or clay.
 - (iii) The curtain drain is designed to lower the seasonal high-water table 6 inches or less.
 - (iv) The area in which the leachfield is proposed to be located and the area 100 feet upslope meet the following requirements:
 - (I) has permeable soil or soil that does not have soil with a texture of silt loam, silt, sandy clay loam, clay loam, silty clay loam, sandy clay, silty clay, or clay;
 - (II) is underlain by a low permeable soil with a texture of silt loam, silt, sandy clay loam, clay loam, silty clay loam, sandy clay, silty clay, or clay;
 - (III) has a slope of 5 percent or greater with a seasonal high-water table 24 inches or greater below ground surface where the low permeable soil layer is 12 inches or more below the seasonal high-water table; and
 - (IV) has a recharge area extending 100 feet or more upslope of the curtain drain.
 - (v) Unless the seasonal high-water table is determined by water table monitoring conducted pursuant to § 1-905, when a hydrogeological analysis is completed, the seasonal high-water table is determined by soil evaluation conducted pursuant to § 1-910(g).
- (2) To seek pre-authorization to install and use a curtain drain, a prospective applicant, prior to submitting an application, shall submit the following to the Secretary:
 - (A) A letter requesting authorization to install and use a curtain drain.
 - (B) A signed property access form.
 - (C) A plan prepared by a Class I, Class B, or Class BW designer or hydrogeologist that:
 - (i) shows the location and point of discharge of the drain;
 - (ii) depicts construction details for the drain including a profile and typical sections;

- (iii) specifies the type of construction material to be used that is sufficient to transmit the water from the site and to prevent clogging of the drain that will decrease its effectiveness. Acceptable material shall be:
 - (I) leachfield stone;
 - (II) perforated or other porous pipe; and
 - (III) filter fabric wrapped around the leachfield stone to prevent clogging;
 - (iv) depicts the design of the outlet of the drain to prevent erosion and clogging;
 - (v) depicts cleanouts to grade;
 - (vi) depicts rodent guards at the outlet of the drain; and
 - (vii) demonstrates compliance with all isolation distances required pursuant to § 1-912.
 - (D) Supporting information required by the Secretary, including permeability and sieve analysis of the soil at the site, when necessary to establish the effectiveness of the proposed drain.
 - (3) The Secretary, upon determining that the plan and any supporting information provided by the designer or hydrogeologist complies with Subsection (a)(2)(C) and (D), shall issue an authorization letter with conditions to install and use the drain.
- (b) Requirements for sites following re-grading.
 - (1) When a site is re-graded for the purpose of constructing a leachfield, the following requirements shall be met:
 - (A) Soil excavations required pursuant to § 1-910 shall be performed after re-grading.
 - (B) There shall be a minimum of 6 feet of naturally occurring soil between the downslope side of any area that has been re-graded and either the edge of a leachfield or limits of the fill material for the particular type of leachfield that is intended, whichever is larger.
 - (2) It is acceptable to add soil to an area in order to comply with the isolation distance required pursuant to § 1-912 between slopes greater than 30 percent and the edge of the leachfield or limits of the fill material for the particular type of leachfield that is intended.
 - (3) Cuts and fills of 1 foot or less do not constitute re-grading.

Note: Appendix C, Figure C-3, depicts a detail of a typical site that was re-graded.

§ 1-907 2-year Time of Travel Management Zone

- (a) A Class 1, Class B, or Class BW designer is required to submit the installation certification for the installation of a wastewater system designed using a 2-year time of travel management zone.
- (b) The required depths of naturally occurring soil and fill material between the bottom of a leachfield and the seasonal high-water table required pursuant to § 1-903 may be reduced or eliminated provided:

- (1) the permittee owns or controls all of the property that is located within the 2-year time of travel management zone;
 - (2) there are no public water system or potable water sources within the 2-year time of travel management zone;
 - (3) the design flow for the wastewater system is 700 gallons per day or less; and
 - (4) a hydrogeologist delineates the 2-year time of travel management zone pursuant to Subsection (c).
- (c) The 2-year time of travel management zone shall meet the following requirements:
- (1) The naturally occurring soil throughout the management zone shall be consistent and horizontally extensive.
 - (2) The naturally occurring soil shall be of sandy clay loam, clay loam, silty clay loam, sandy clay, silty clay, or clay texture.
 - (3) The management zone shall extend a minimum of 50 feet uphill and to the sides of the leachfield and a distance downslope of the leachfield equal to the 2-year time of travel.
 - (4) The 2-year time of travel calculation shall account for effluent movement in both shallow and more permeable layers and the deeper less permeable layers. The assumptions must include movement through the shallow layers when the induced water table formed by the combination of the effluent and the seasonal high-water table is present within the shallow layers.
- (d) A leachfield designed using a 2-year time of travel management zone shall demonstrate:
- (1) that the induced water table shall remain at least 6 inches below the surface of the naturally occurring soil throughout the management zone; and
 - (2) through site specific permeability testing and hydrogeological analysis, that includes any seasonal pathways such as drying cracks, that there will be at least a 2-year time of travel within the management zone from the bottom of the leachfield to bedrock.

§ 1-908 Septic Tanks

- (a) A septic tank shall be sized for the minimum capacity established in Table 9-1, except in the following circumstances:
- (1) Multiple tanks placed in series provide the minimum tank capacity established in Table 9-1.
 - (2) The Secretary determines that a smaller tank will retain the wastewater for a minimum of two days prior to discharge, based on information submitted by an applicant's or prospective applicant's designer.
 - (3) When a pump is installed within the septic tank, the capacity of the tank shall be increased above the capacities in Table 9-1 to provide required capacity for the dose volume and required emergency storage capacity.
 - (4) The septic tank capacity shall be increased by a minimum of 50 percent above the capacities in Table 9-1 if the building or structure to be served by the wastewater system will include a garbage disposal.
 - (5) If a pump station discharges wastewater to a septic tank, the capacity of the septic tank shall be increased above the capacities in Table 9-1 to provide adequate

retention time to retain settleable solids, and to allow the formation of the scum layer.

**Table 9-1
Minimum Capacities for Septic Tanks**

Design Flow, Gallons Per Day	Liquid Capacity Below the Bottom of the Outlet
560 or less	1000 gallons
Greater than 560 – less than 6500	2 times design flow

- (b) The design of each septic tank shall meet the following requirements:
- (1) Septic tanks shall be structurally sound and constructed of materials that are not subject to extensive corrosion or decay, such as the following:
 - (A) Reinforced precast concrete tanks that comply with ASTM standards and have a minimum wall thickness of 3 inches and adequate reinforcing to facilitate handling.
 - (B) Fiberglass and plastic tanks that have approval by the National Sanitation Foundation (NSF), the American Society of Testing and Materials (ASTM), International Association of Plumbing and Mechanical Officials (IAPMO), Canadian Standards Association (CSA), or the American Water Works Association (AWWA).
 - (2) There shall be access to each compartment of the septic tank for inspection and cleaning. Access to each compartment of a tank shall:
 - (A) be available by means of either a removable cover or a manhole of at least 18 inches in diameter; and
 - (B) allow access to both inlet and outlet devices.
 - (3) Septic tanks shall have at least one manhole access to grade. If only one access to grade is provided, it shall provide access to the effluent filter. The access riser shall:
 - (A) be of sufficient diameter to allow removal of any septic tank covers; and
 - (B) have covers that are tight fitting and designed to prevent entry by children.
 - (4) Inlets shall enter the tank at least 3 inches above the liquid level in the tank to allow for momentary rises in liquid level during discharges to the tank.
 - (5) Inlets consisting of a vented inlet tee or baffle to direct the incoming wastewater downward. The tee or baffle shall penetrate at least 6 inches below the liquid level but, in no case, shall the penetration be greater than that allowed for the outlet device.
 - (6) Outlet devices shall retain scum in the tank and limit the amount of sludge that can be accommodated without the scouring that causes sludge to discharge in the effluent from the tank. The outlet device should generally extend to a distance below the surface equal to:
 - (A) 40 percent of the liquid depth; or
 - (B) 35 percent of the liquid depth for horizontal cylindrical tanks.
 - (7) An effluent filter shall be placed on the outlet pipe that:
 - (A) prevents the passage of solids larger in size than 1/8th inch; and
 - (B) has NSF/ANSI 46 certification or has completed other similar third-party testing that is accepted by the Secretary on a case-by-case basis.

- (8) When multiple septic tanks are proposed in a series to provide the required tank capacity, the following requirements apply:
 - (A) If the tanks are of unequal capacity, the design shall place the largest capacity tank upstream of tanks of lesser capacity.
 - (B) Only the outlet pipe of the final tank is required to have an effluent filter although optional effluent filters, if provided, shall meet the requirements of Subsection (b)(7) and manhole access for each filter shall be provided and shall meet the requirements of Subsection (b)(3).
 - (9) When a septic tank is located in the seasonal high groundwater, the tank shall be provided proper anchors when necessary to prevent movement of the tank.
 - (10) No portion of a septic tank shall be placed under a porch, deck, or other type structure.
- (c) The septic tank shall be pumped to prevent settleable solids and scum from exiting the tank that may cause a downstream component of the wastewater system to improperly operate.
 - (d) Effluent filters shall be cleaned to prevent solids from clogging the filter.
 - (e) The excavation for installing a septic tank shall not be located within:
 - (1) 10 feet of the edge of the leachfield stone or other infiltrative surface for an in-ground trench or in-ground bed;
 - (2) 25 feet of the limits of the fill material in the downslope direction, and 10 feet of the limits of the fill material in all other directions, for an at-grade leachfield;
 - (3) 25 feet of the limits of the fill material in the downslope direction, and 10 feet of the limits of the fill material in all other directions for a mound; and
 - (4) 25 feet of the edge of the enclosure in the downslope direction, and 10 feet from the edge of the enclosure in all other directions for a bottomless sand filter.

§ 1-909 Grease Tanks

- (a) A grease tank shall be installed in the sanitary sewer service line serving only plumbing fixtures within a building or structure with non-residential uses where wastewater from the fixtures, such as kitchen sinks and dishwashers in restaurants, cafeterias, and school kitchens, may include grease.
 - (1) A grease tank shall not be installed in other sanitary sewer service lines.
 - (2) The installation of an interior grease trap or interceptor shall not substitute for the grease tank.
- (b) The grease tank shall discharge to a septic tank prior to discharging to a leachfield.
- (c) The grease tank shall have a minimum capacity of 1000 gallons and shall be sized based on the method described below derived from the 1997 Uniform Plumbing Code.
 - (1) $\text{Meals per peak hour (A) X Wastewater Flow Rate (B) X Retention Time (C) X Storage Factor (D) = Size Requirement in liquid capacity in gallons.}$
 - (A) $\text{Meals per peak hour = Number of meals served at peak operating hour (Seating Capacity) X Peak Factor or maximum number of seats, where Peak Factor is:}$

- (i) Peak Factor for fast food restaurants1.33
 - (ii) Peak Factor for all other food service types ...1.0
 - (B) Wastewater Flow Rates:
 - (i) With dishwasher 6-gallon flow
 - (ii) Without dishwasher 5-gallon flow
 - (iii) Single Service kitchen 2-gallon flow
 - (iv) Garbage Grinder (Food waste disposer) 1-gallon flow
 - (C) Retention Times:
 - (i) Commercial kitchen waste/dishwasher 2.5 hours
 - (ii) Single service kitchen 1.5 hours
 - (D) Storage Factors:
 - (i) Fully equipped commercial kitchen ...8 hour operation ...1
 - (ii) Fully equipped commercial kitchen ...16 hour operation ..2
 - (iii) Fully equipped commercial kitchen24 hour operation ..3
 - (iv) Single service kitchen1.5
 - (2) For the purposes of this Subsection, “single service kitchen” means a kitchen:
 - (A) where the food preparation consists of only heat and serve;
 - (B) that uses service items not expected to be used again on the premises; and
 - (C) where service items that are reused are not washed on the premises.

The operation of grills, frying machines, or cooking devices other than those used to heat food does not constitute a single service kitchen.
 - (3) The Secretary shall accept alternative designs when the applicant provides information from a designer demonstrating that the alternative design provides equal or greater grease removal. The information shall include consideration of grease removal when transported by ultra-hot water.
- (d) The design of the grease tank shall meet the following requirements:
- (1) Grease tanks shall be structurally sound and constructed of materials that are not subject to extensive corrosion or decay, such as the following materials:
 - (A) heavy gauge steel tanks with continuous welds;
 - (B) reinforced precast concrete tanks that comply with ASTM standards with a minimum wall thickness of 3 inches and adequate reinforcing to facilitate handling; and
 - (C) fiberglass and plastic tanks that have approval by the National Sanitation Foundation (NSF) , the American Society of Testing and Materials (ASTM), International Association of Plumbing and Mechanical Officials (IAPMO), Canadian Standards Association (CSA) or the American Water Works Association (AWWA).
 - (2) Tanks shall have the inlet and outlet baffles extend from 12 inches above the bottom of the tank and to well above the waterline to allow airflow back into the building plumbing system.
 - (3) There shall be access to each compartment of the grease tank for inspection and cleaning. Access to each compartment of a tank shall:
 - (A) be available by means of either a removable cover or a manhole of at least 18 inches in diameter;
 - (B) allow access to both inlet and outlet devices; and
 - (C) have covers that are tight fitting and designed to prevent entry by children.

- (4) When the grease tank is located in the seasonal high groundwater, the tank shall be provided proper anchors when necessary to prevent movement of the tank.
- (e) Grease tanks shall be pumped to prevent grease from exiting the tank that may cause a downstream component of the wastewater system to improperly operate.

§ 1-910 Soil Evaluation

- (a) For all wastewater systems, soil conditions within the area in which a leachfield or a replacement area is proposed to be located shall be evaluated to determine the design of the leachfield that may be used.
- (b) Soil conditions within the area in which a leachfield or a replacement area is proposed to be located shall be evaluated by completing the number of soil excavations necessary to demonstrate, and describing soil to a depth necessary to demonstrate, that the area complies with the depths of naturally occurring soil required pursuant to § 1-903.
- (c) The minimum number of soil excavations for specific leachfields.
 - (1) For in-ground leachfields and at-grade leachfields that dispose of 600 gallons of effluent per day or less, a minimum of 2 soil excavations shall be performed in the area in which each leachfield and replacement area is proposed to be located.
 - (2) For a leachfield in a mound or in a bottomless sand filter that dispose of 600 gallons of effluent per day or less, a minimum of 3 soil excavations shall be performed in the area in which each leachfield and replacement area is proposed to be located. The excavations shall be spaced to confirm the soil under the leachfield and 25 feet downslope of the limits of the fill material for the mound or filter.
 - (3) The Secretary may allow fewer soil excavations, upon an applicant's request, when the applicant's designer provides information demonstrating that soil is uniform throughout the area for the leachfield or replacement area.
 - (4) The Secretary may require additional soil excavations to confirm complying soil conditions within the area in which a leachfield or a replacement area is proposed to be located.
- (d) Soil excavations shall be conducted using a backhoe or similar equipment unless an alternative method to evaluate the soil is authorized by the Secretary.
- (e) Soil shall be described and recorded for each soil horizon from ground surface according to the U.S. Department of Agriculture (USDA), Natural Resources Conservation Service (NRCS) Field Book for Describing and Sampling Soil. The description shall include the following:
 - (1) color based on a description with Munsell® Soil Color notation, e.g. 10YR 4/3 (Brown);
 - (2) redoximorphic features and mottling;
 - (3) texture, as identified by the full name or the following acronyms:
 - (A) COS = coarse sand
 - (B) S = sand
 - (C) FS = fine sand

- (D) VFS = very fine sand
 - (E) LCOS = loamy coarse sand
 - (F) LS = loamy sand
 - (G) LFS = Loamy fine sand
 - (H) LVFS = loamy very fine sand
 - (I) COSL = coarse sandy loam
 - (J) SL = sandy loam
 - (K) FSL = fine sandy loam
 - (L) VFSL = very fine sandy loam
 - (M) L = loam
 - (N) SIL = silt loam
 - (O) SI = silt
 - (P) SC = sandy clay
 - (Q) SCL = sandy clay loam
 - (R) CL = clay loam
 - (S) SICL = silty clay loam
 - (T) SIC = silty clay
 - (U) C = clay;
- (4) structure according to the structure types identified on Table 9-2; and
 - (5) consistence determined by rupture resistance or excavation difficulty.
- (f) Notwithstanding Subsection (e), soil descriptions and recordings completed prior to the effective date of these Rules may be accepted by the Secretary when the descriptions and recordings identify:
- (1) the soil texture corresponding to the name or acronym in Subsection (e)(3); and
 - (2) soil structure corresponding to the structure types identified on Table 9-2 or, in the absence of identifying structure, the soil evaluation shall be based on the most limiting soil structure identified in Table 9-2 for the reported soil texture.
 - (3) For soil descriptions and recordings completed prior to January 1, 2007, the Secretary will require one or more soil excavations to confirm the accuracy of the recorded soil descriptions. When determining the number of confirming soil excavations, the Secretary shall consider the consistency of the soil texture, recorded depth to the seasonal high groundwater table, depth to bedrock, depth of soil over a soil with a consistence of firm or denser, and number of existing excavations.
- (g) The Secretary may require an applicant to submit the results of a sieve analysis using the USDA method of analysis to confirm the texture of the soil identified pursuant to Subsection (e).
- (h) Evidence of the seasonal high-water table and evidence of soil saturation below ground surface shall be determined by observation within each soil horizon of each soil excavations of:
- (1) sidewall seepage;
 - (2) standing water; and
 - (3) the presence of redoximorphic features or color patterns indicative of soil saturation.

§ 1-911 Maximum Application Rates for Leachfields

- (a) The maximum application rate for sizing a leachfield in a mound shall be 1.0 gallon per square foot per day.
- (b) The maximum application rate for sizing a leachfield in a bottomless sand filter system shall be determined based on Table 9-2, using the most limiting naturally occurring soil texture and structure identified within 0 to 3 feet below ground surface identified from soil excavations.
- (c) The maximum application rate for sizing an in-ground leachfield or an at-grade leachfield shall be determined based on Table 9-2 using the most limiting naturally occurring soil texture and structure identified within 0 to 3 feet below the bottom of the leachfield stone or other infiltrative surface of the leachfield identified from soil excavations.

**Table 9-2
Application Rates Established Using Soil Excavation**

Soil Characteristics		Application Rates (gallons per square foot per day)			
Texture	Structure Type ¹	In-Ground Trench	In-ground Bed	At-Grade Leachfield	Leachfield in a Bottomless Sand Filter
Very Coarse Sand or Coarser	SG	See § 1-919(b)	See § 1-919(b)	1.00	1.00
Coarse Sand, Sand	SG	1.50	1.20	1.00	1.00
Loamy Coarse Sand, Loamy Sand	SG	1.50	1.20	1.00	1.00
Fine Sand, Very Fine Sand, Loamy Fine Sand, Loamy Very Fine Sand	SG	1.00	0.80	0.80	0.80
	MA/PL	0.50	0.40	0.40	0.40
	PR/ABK/SBK/GR	0.70	0.60	0.60	0.60
Coarse Sandy Loam, Sandy Loam	MA/PL	0.50	0.40	0.40	0.40
	PR/ABK/SBK/GR	0.70	0.60	0.60	0.60
Fine Sandy Loam, Very Fine Sandy Loam	MA/PL	0.50	0.40	0.40	0.40
	PR/ABK/SBK/GR	0.60	0.50	0.50	0.50
Loam	MA/PL	0.50	0.40	0.40	0.40
	PR/ABK/SBK/GR	0.60	0.50	0.50	0.50
Silt Loam, Silt	MA/PL	0.30	0.20	0.20	N/A

Soil Characteristics		Application Rates (gallons per square foot per day)			
Texture	Structure Type ¹	In-Ground Trench	In-ground Bed	At-Grade Leachfield	Leachfield in a Bottomless Sand Filter
	PR/ABK/SBK/GR	0.40	0.30	0.30	N/A
Sandy Clay Loam, Clay Loam, Silty Clay Loam	MA/PL	0.25	0.20	0.20	N/A
	PR/SBK/GR	0.30	0.20	0.20	N/A
Sandy Clay, Clay, Silty Clay	N/A (See § 1-926)				

Adapted from J. Tyler, 2000.

¹ The abbreviations used for structure are: SG = single grain; GR = granular; MA = massive; PL = platy; PR = prismatic; ABK = angular blocky; SBK = subangular blocky.

§ 1-912 Horizontal Isolation Distances and Isolation Zones for Components of Wastewater Systems

- (a) Table 9-3 identifies the minimum horizontal isolation distance that each identified component of a wastewater system, and that each replacement area, shall be located from all portions of the identified features and objects, unless the Secretary has authorized a reduction to the isolation distance or increased the isolation distance pursuant to Subsections (e) or (f), or unless an isolation zone is required in lieu of an isolation distance for the particular feature or object.

**Table 9-3
Horizontal Isolation Distances, in Feet, for Features and Objects**

Features and Objects	Sanitary Sewer Collection Line, Sanitary Sewer Service Line and Manholes	Wastewater Tanks ¹	In-Ground Leachfields and Replacement Areas
	Closest Portion of the Collection Line, Service Line, or Manhole	Outside Edge of the Tanks	Edge of Leachfield Stone, Other Infiltrative Surface, or Replacement Areas
Curtain drains	N/A	10	75

Features and Objects	Sanitary Sewer Collection Line, Sanitary Sewer Service Line and Manholes	Wastewater Tanks¹	In-Ground Leachfields and Replacement Areas
	Closest Portion of the Collection Line, Service Line, or Manhole	Outside Edge of the Tanks	Edge of Leachfield Stone, Other Infiltrative Surface , or Replacement Areas
(located downslope of a leachfield)			
Curtain drains (located upslope of a leachfield)	N/A	10	35
Drainage swales and ditches with seeps, including seasonal seeps (located downslope of a leachfield)	N/A	25	75
Drainage swales and ditches with seeps, including seasonal seeps (located upslope of a leachfield)	N/A	25	35
Drainage swales and ditches without seeps	N/A	N/A	25
Foundation, footing, or perimeter of a building or structure with a drain (located downslope of a leachfield)	N/A	10	75
Foundation, footing, or perimeter of a building or structure with a drain (located upslope of a leachfield)	N/A	10	20
Foundation, footing, or perimeter of a building or structure without drains (located downslope of a leachfield)	N/A	10	20
Foundation, footing, or perimeter of a building or structure without a drain (located upslope of a leachfield)	N/A	10	20
Potable water sources in bedrock or confined surficial aquifer, (proposed, existing, or permitted)	50	Requires isolation zone (See Table 9-4)	
Potable water sources in an unconfined surficial aquifer (proposed, existing, or permitted)	75	Requires isolation zone (See Table 9-4)	
Property lines	10	10	25

Features and Objects	Sanitary Sewer Collection Line, Sanitary Sewer Service Line and Manholes	Wastewater Tanks ¹	In-Ground Leachfields and Replacement Areas
	Closest Portion of the Collection Line, Service Line, or Manhole	Outside Edge of the Tanks	Edge of Leachfield Stone, Other Infiltrative Surface, or Replacement Areas
Public water sources (proposed, existing, or permitted)	50	Requires isolation zone (See Table 9-4)	
Roadways, driveways, parking lots	N/A	5	10
Slopes exceeding 30 percent	N/A	10	25
Surface water, normal high-water elevation ²	10	25	50
Stormwater conveyance/treatment/control practice	10	25	50
Trees	10	10	10
Water mains (proposed, existing, or permitted)	Distances and requirements established in § 1-1007 apply in lieu of this Section	50	50
Water service lines and water service pipes (pressure) (proposed, existing, or permitted)	Distances and requirements established in § 1-1007 apply in lieu of this Section	25	25
Water service lines and water service pipes (suction) (proposed, existing, or permitted)	Distances and requirements established in § 1-1007 apply in lieu of this Section	50	100
Water sources that are not a potable water source or public water source	10	50	100

Features and Objects	Sanitary Sewer Collection Line, Sanitary Sewer Service Line and Manholes	Wastewater Tanks¹	In-Ground Leachfields and Replacement Areas
	Closest Portion of the Collection Line, Service Line, or Manhole	Outside Edge of the Tanks	Edge of Leachfield Stone, Other Infiltrative Surface, or Replacement Areas
Water storage tanks (atmospheric tank located below ground surface) (proposed, existing, or permitted)	50	50	50

**Table 9-3 (continued)
Horizontal Isolation Distances, in Feet, for Features and Objects**

Features and Objects	At-Grade Leachfields		Leachfields in Mounds			Leachfields in Bottomless Sand Filters
	Edge of Leachfield Stone	Limits of Fill Material	Leachfield	Effective Basal Area	Limits of Fill Material	Enclosure
Curtain drains (located upslope of a leachfield)	35	35	35	35	35	35
Drainage swales and ditches with seeps, including seasonal seeps (located downslope of a leachfield)	75	50	75	75	50	75
Drainage swales and ditches with seeps, including seasonal seeps (located upslope of a leachfield)	35	10	35	35	10	35

Features and Objects	At-Grade Leachfields		Leachfields in Mounds			Leachfields in Bottomless Sand Filters
	Edge of Leachfield Stone	Limits of Fill Material	Leach-field	Effective Basal Area	Limits of Fill Material	Enclosure
Drainage swales and ditches without seeps	25	10	25	25	10	25
Curtain drain, foundation, footing, or perimeter of a building or structure with a drain (located downslope of a leachfield)	75	50	75	75	50	75
Foundation, footing, or perimeter of a building or structure with a drain (located upslope of a leachfield)	20	20	20	20	20	20
Foundation, footing, or perimeter of a building or structure without drains (located downslope of a leachfield)	35	35	35	35	35	35
Foundation, footing, or perimeter of a building or structure without a drain (located upslope of a leachfield)	20	10	20	20	10	20
Potable water sources in bedrock or confined surficial aquifer, (proposed, existing, or permitted)	Requires isolation zone (See Table 9-4)					
Potable water sources in an unconfined surficial aquifer (proposed, existing, or permitted)	Requires isolation zone (See Table 9-4)					

Features and Objects	At-Grade Leachfields		Leachfields in Mounds			Leachfields in Bottomless Sand Filters
	Edge of Leachfield Stone	Limits of Fill Material	Leach-field	Effective Basal Area	Limits of Fill Material	Enclosure
Property lines	25	10 for upslope and sides, 25 for downslope	25	25	10 for upslope and sides, 25 for downslope	25
Public water sources (proposed, existing, or permitted)	Requires isolation zone (See Table 9-4)					
Roadways, driveways, parking lots	10	10 for upslope and sides, 25 for downslope	10	10	10 for upslope and sides, 25 for downslope	10 for upslope and sides, 25 for downslope
Slopes exceeding 30 percent	25	25	25	25	25	25
Stormwater conveyance/treatment/control practice	50	50	50	50	50	50
Surface water, normal high-water elevation ²	50	50	50	50	50	50
Trees	10	0	10	10	0	10
Water mains (proposed, existing, or permitted)	50	10 for upslope and sides, 25 for downslope	50	50	10 for upslope and sides, 25 for downslope	50
Water service lines or water service pipes (pressure) (proposed, existing, or permitted)	25	10 for upslope and sides, 25 for downslope	25	25	10 for upslope and sides, 25 for downslope	25
Water service lines or water service pipes (suction) (proposed, existing, or permitted)	100	25	100	100	10 for upslope and sides, 25 for downslope	100
Water sources that are not potable	100	10 for upslope and	100	100	10 for upslope	100

Features and Objects	At-Grade Leachfields		Leachfields in Mounds			Leachfields in Bottomless Sand Filters
	Edge of Leachfield Stone	Limits of Fill Material	Leach-field	Effective Basal Area	Limits of Fill Material	Enclosure
water sources or public water sources		sides, 25 for downslope			and sides 25 for downslope	
Water storage tanks (atmospheric tank located below ground surface) (proposed, existing, or permitted)	50	25	50	50	25	50

¹ Wastewater Tanks include septic tanks, pump stations, dosing siphons, holding tanks, wastewater storage tanks, wastewater treatment tanks, sand filters, constructed wetlands, and grease tanks.

² The horizontal location to surface water shall allow for possible future widening of the surface water due to bank erosion.

- (b) Subsections (c) and (d), in conjunction with Table 9-4, identify the size and shape of the isolation zone around the identified proposed, existing, or permitted drinking water sources in which no portion of each identified component of a wastewater system, and of each replacement area, shall be located, unless the Secretary has authorized a reduction to the isolation zone or required a larger isolation zone pursuant to Subsections (e) or (f).

**Table 9-4
Distances, in Feet, Used to Create Isolation Zones Around Drinking Water Sources**

Proposed, Existing, or Permitted Drinking Water Sources (by gallons per minutes design rate)		Leachfields ¹ and Replacement Areas (< 2000 gallons per day design flow)	Leachfields ¹ and Replacement Areas (≥ 2000 to < 6500 gallons per day design flow)	Wastewater Tanks ²
Potable water sources or Public water sources for community water systems, non-community non-transient water systems, and transient non-community water systems	≤ 2.0	X = 100 Y = 200	X = 150 Y = 300	X = 50 Y = 50
	> 2.0 and ≤ 5.0	X = 150 Y = 300	X = 150 Y = 300	
	> 5.0 and ≤ 8.0	X = 200 Y = 400	X = 200 Y = 400	

Proposed, Existing, or Permitted Drinking Water Sources (by gallons per minutes design rate)		Leachfields ¹ and Replacement Areas (< 2000 gallons per day design flow)	Leachfields ¹ and Replacement Areas (≥ 2000 to < 6500 gallons per day design flow)	Wastewater Tanks ²
(in bedrock or confined surficial aquifer)	> 8.0	X = 200 Y = 1000		
Potable water sources or Public water sources for community water systems, non-community non-transient water systems, and transient non-community water systems (in an unconfined surficial aquifer)	≤ 8.0	X = 150 Y = 500	X = 150 Y = 1000	X = 75 Y = 75
	> 8.0	X = 200 Y = 1000		

¹ For the purposes of this table, the term “leachfields” includes the edge of the leachfield stone or other infiltrative surface for in-ground leachfields; the edge of leachfield stone for at-grade leachfields; the leachfield and effective basal area for leachfields in mounds; and the enclosure for leachfields in bottomless sand filters. It does not include the limits of fill material for in-ground leachfields, at-grade leachfields, or a leachfields in mounds.

² Wastewater Tanks include septic tanks, pump stations, dosing siphons, holding tanks, wastewater storage tanks, wastewater treatment tanks, sand filters, constructed wetlands, and grease tanks.

Note: See § 1-903(g) for additional restrictions concerning the location of a wastewater system components in proximity of a Public Community Water System.

- (c) One of the following methods shall be used to determine the size and shape of the required isolation zone around proposed, existing, or permitted drinking water sources, with X and Y equaling the numbers identified in Table 9-4:
- (1) When drawing a size and shape around a source and detailed topographical data is not available, the shape around the source shall be Y from the source.
 - (2) When drawing the size and shape around a source, and all points of the shape are at the same or lower elevation than the elevation of the source, the shape around the source shall be X from the source.
 - (3) When drawing the size and shape around a source, and all points of the shape are at a higher elevation than the elevation of the source, the shape around the source shall be Y from the source.
 - (4) When drawing the size and shape around a source, and not all points of the shape are at a higher elevation than the elevation of the source, the shape around the source shall be:
 - (A) a circle with a radius of Y from the source;

- (B) when Y is variable, a shape around the source so that all points in the shape are Y from the source;
 - (C) a circle around the source so that all points are X from the source and, from the points on either side of the source where the circle intersects the contour elevation that the source is on, draw lines beginning at these intersections extending upslope and perpendicular to the contours until these lines intersect an arc with a radius equal to Y; or
 - (D) when drawing the shape in (c)(4)(C), the lines continuing upslope and perpendicular to the contours reach a crest less than Y from the source and, from the crest, the contours continue to decrease a distance Y from the source, the distance upslope of the source shall be Y and the points along the crest, or X if the crest is less than X, where those points intersect with Y.
- (d) Notwithstanding Subsection (c), when a 2-year time of travel management zone is determined for a leachfield, the size and shape of the required isolation zone around proposed, existing, or permitted drinking water sources to be isolated from the leachfield shall be identified pursuant to Subsection (c) except that the portion of the isolation zone overlapping the leachfield's 2-year time of travel management zone shall be replaced with the leachfield's 2-year time of travel management zone, provided:
- (1) When the drinking water source is grouted, in no case shall any point along the isolation zone be less than 50 feet from the drinking water source.
 - (2) When the drinking water source is not grouted, in no case shall any point along the isolation zone be less than 100 feet from the drinking water source.
- (e) An applicant or prospective applicant may submit a written request to the Secretary for a reduction in the required isolation distance or isolation zone for a particular feature or object.
- (1) The Secretary shall authorize the use of a reduced isolation distance or isolation zone for a particular feature or object when the Secretary determines that the isolation distance specified in Table 9-4 or isolation zone identified pursuant to Subsection (c) is unnecessary to protect human health and the environment because the specific site conditions, or the construction techniques and pipe materials, will prevent the potential subsurface flow of effluent from impacting the feature or object and will prevent the performance of the wastewater system from being impacted by the feature or object.
 - (2) In determining whether to authorize the use of a reduced isolation distance or isolation zone, the Secretary shall consider the following factors:
 - (A) the ground slope;
 - (B) groundwater flow;
 - (C) depth to the seasonal high groundwater and the induced water table;
 - (D) depth of the impeding soil layer;
 - (E) soil texture and structure;
 - (F) travel time for effluent from a component of a wastewater system to reach a feature or object; and
 - (G) construction techniques or pipe materials that provides equal or greater protection to the wastewater system or feature or object than afforded by the isolation distance or isolation zone.

- (3) The Secretary shall not authorize a reduction to the distances used to create an isolation zone around a drinking water source pursuant to Subsection (c) to less than the following:
 - (A) When there is a continuous impeding soil layer from the leachfield to the source, and it is demonstrated the source is grouted, has no annular space, or soil sealed the source casing to prevent contaminant migration along the casing, X and Y shall not be less than 100 feet.
 - (B) When groundwater flow from beneath the leachfield is not towards a drinking water source, X and Y shall not be less than 100 feet.
 - (C) When a hydrogeological investigation is completed that reveals that groundwater flow from beneath the leachfield does not flow toward a drinking water source under pumping conditions, X and Y shall not be less than 100 feet.
 - (D) When a 2-year time of travel management zone is determined, X and Y shall not be less than 50 feet when the drinking water source is grouted.
 - (E) When a 2-year time of travel management zone is determined, X and Y shall not be less than 100 feet when the drinking water source is not grouted.
- (4) The burden shall be on the applicant or prospective applicant to provide information from a designer that addresses the factors in Subsection (e)(2) and enables the Secretary to reach a determination.
- (5) The Secretary's determination shall be in writing and indicate the reduced isolation distance or isolation zone.
- (f) The Secretary shall require a greater isolation distance or larger isolation zone for a particular feature or object when the Secretary determines that, based on the specific site conditions described in an application, a greater isolation distance or larger isolation zone is necessary to prevent the potential subsurface flow of effluent from impacting the feature or object or to prevent the feature or object from impacting the performance of the wastewater system.

Note: Appendix C, Figure C-4, depicts an example for drawing an isolation zone around a drinking water source.

§ 1-913 Wastewater System Presumptive Isolation Zone

- (a) A presumptive isolation zone shall be identified, using the methods identified in § 1-1104, around proposed leachfields, replacement areas, and wastewater tanks in which a potable water source with a design rate of less than or equal to 2.0 gallons per minute, assuming it would be located in bedrock or confined surficial aquifer, cannot be located.
- (b) Each wastewater system presumptive isolation zone identified pursuant to Subsection (a) shall be considered in conjunction with the requirements of § 1-307 to determine if notification to adjacent landowners is required pursuant to § 1-307 and considered in conjunction with the requirements of Appendix A to determine if the wastewater system presumptive isolation zone is required to be shown on the site plan.

§ 1-914 Dosing and Pressure Distribution

- (a) A wastewater system is required to use dosing when:
 - (1) the design proposes more than 500 linear feet of distribution piping within a leachfield or combination of leachfields; or
 - (2) the wastewater system uses pressure distribution.
- (b) The use of dosing, including pressure distribution, in the design of a wastewater system is otherwise optional, but it is recommended for all wastewater systems.
- (c) Dosing shall be accomplished by pumps, dosing siphons, or other devices that can provide sufficient flow and pressure to meet the design requirements of the distribution system.
- (d) Requirements for pressure distribution
 - (1) Except where otherwise specified in these Rules, wastewater systems using pressure distribution shall meet the following additional requirements:
 - (A) maintain a minimum pressure of 1 pound per square inch (or 2.3 feet of head) at the end of each distribution line;
 - (B) maintain a maximum of a 10 percent difference in the per-square foot application rate between any 2 trenches or beds within a system;
 - (C) prevent any trench or bed from being loaded at a rate exceeding that allowed based on the application rate for the soil and factors associated with advanced treatment except when approved as an innovative/alternative system;
 - (D) maintain a maximum 10 percent difference in the discharge rate between any 2 orifices in a single trench or bed;
 - (E) maintain a minimum dose volume 5 times the volume of the distribution network that must be filled during each dose cycle;
 - (F) maintain a minimum of 4 dosing cycles per day based on the design flow of the wastewater system, although the Secretary may allow a lower number of dosing cycles when the design flow is low and 4 doses per day are impractical for pump sizing and operation (examples include when the dose volume, based on 4 doses per day, for a low design flow, cannot fill the laterals and maintain proper pressure at each orifice or the pump run time is less than the recommended run time); and
 - (G) maintain at least one orifice for each 25 square feet of leachfield area unless there is a specific requirement in these Rules for additional orifices.
 - (2) Pressure distribution pipe shall:
 - (A) be smooth, rigid pipe;
 - (B) have the ends of each lateral within the piping network designed with a flushing cleanout to allow for periodic cleaning;
 - (C) be constructed so that there is access to the piping system for flushing of the piping system;
 - (D) be designed so the distribution pipe within a trench or bed is laid level;
 - (E) be designed so that pipes serving separate trenches or beds that are at different elevations have even distribution; and
 - (F) have orifices that:
 - (i) have a minimum diameter of 1/8 inch;

- (ii) may face up when the orifices are protected by orifice shields; and
 - (iii) may face down without an orifice shield.
- (e) Notwithstanding Subsection (d), the Secretary may approve alternative designs of pressure distribution provided the design achieves distribution of the effluent in a leachfield that equals the distribution of effluent in a leachfield that would be obtained by the application of Subsection (d).
- (f) During operation, settled solids shall be periodically removed from pump stations, dosing siphons, or other devices used to pressurize a leachfield to prevent passage of solids to downstream components.

§ 1-915 Time Dosing

- (a) A Class 1, Class A, Class B, or Class BW designer is required to submit the installation certification for the installation of wastewater systems using time dosing.
- (b) A wastewater system is required to use time dosing where specified in these Rules. The use of time dosing in the design of a wastewater system is otherwise optional.
- (c) General requirements for time dosing.
 - (1) Wastewater systems that are time dosed:
 - (A) shall distribute the design flow to a leachfield in small equal doses distributed evenly over 24 hours.
 - (B) shall be designed using pressure distribution that uses a pump and complies with § 1-914(d)(1)(A)-(E) and (G) and § 1-914(d)(2).
 - (2) Unless otherwise authorized by the Secretary, the dose volume shall not exceed 10 percent of the design flow.
 - (3) A leachfield shall not be dosed more than once in a 30-minute period.
- (d) Pump stations shall:
 - (1) be sized to achieve storage equal to 150 percent of the design flow;
 - (2) have an adjustable timer to control the pump run/rest times/dose volume;
 - (3) have an alarm float;
 - (4) have a cycle counter; and
 - (5) have the following additional floats:
 - (A) a redundant off float (the redundant off float can be controlled by the same float used for the timer enabler); and
 - (B) a peak enabler float between the timer enabler float and the high-water alarm float (the peak enabler float and the high-water alarm can be controlled by the same float).
- (e) When a wastewater system using time dosing includes a pretreatment unit with a discharge pump that is designed using time dosing and discharges to a pump station or dosing siphon, the discharge pump shall either:
 - (1) discharge to a pump station that has the pump on level set to discharge an equal quantity of effluent as being pumped from the pretreatment unit; or

- (2) discharge to a dosing siphon that discharges an equal quantity of effluent as being pumped from the pretreatment unit.

Note: Appendix C, Figure C-5, depicts a detail of a typical time dosing pump station.

§ 1-916 Flow Equalization

- (a) A Class 1, Class A, Class B, or Class BW designer is required to submit the installation certification for the installation of a wastewater system using flow equalization.
- (b) The use of flow equalization in the design of a wastewater system is optional.
- (c) General requirements for flow equalization
 - (1) Notwithstanding § 1-803(h), the use of flow equalization allows a leachfield serving a building or structure or campground with multiple uses to be sized to dispose of the quantity of wastewater calculated by adding together the sum of the design flows for each use of the building or structure or campground in each 24-hour period for a week and dividing by the number of days when effluent will be distributed to the leachfield, provided:
 - (A) The leachfield can be expanded to dispose of the design flow calculated pursuant to § 1-803(h); and
 - (B) If a replacement area is required by §1-902, the replacement area can accommodate the design flow calculated pursuant to § 1-803(h).
 - (2) Wastewater systems that use flow equalization shall:
 - (A) Distribute the wastewater to a leachfield over 7 days when the flows vary greatly by the day of the week (examples include marinas, campgrounds, day use facilities, and places of worship when there are no other uses or activities of the building or facility during the off-peak days such as a daycare or preschool).
 - (B) Be designed using pressure distribution pursuant to § 1-914.
 - (C) Include pump stations that comply with § 1-915(d) to time dose the leachfield except when a treatment unit uses a pump designed to comply with §-915(e) to discharge to a pump station or dosing siphon that discharges to the leachfield.
 - (D) Include storage tanks for flow equalization (also referred to as surge tanks) that are sized to enable the wastewater system to meet the following requirements:
 - (i) when the flow into the system on a particular day exceeds the flow pumped to the leachfield, the remaining volume must be stored in flow equalization storage tanks;
 - (ii) when a following day also results in more flow into the system than is discharged, the remaining volume is added to that from the previous day or days;
 - (iii) based on an analysis of the weekly cycle, the maximum volume that must be stored at any point in time is calculated; and
 - (iv) the storage capacity of the flow equalization storage tanks is 150 percent of the calculated volume with no reduction allowed based on the required storage provided in the pump station.

- (E) Include water meters to record the daily total quantity of water entering the building or structure or campground served by the wastewater system.
- (3) When the design for a wastewater system using flow equalization includes a pretreatment unit, the pretreatment unit shall:
 - (A) be located between the flow equalization storage tanks and the pump station that discharges to the leachfield; and
 - (B) be sized based on the amount of effluent derived in Subsection (c)(1).
- (4) A flow equalization storage tank shall:
 - (A) have a high-water alarm set at an elevation that equals 1.1 times the calculated storage volume; and
 - (B) include a cycle counter to record the number of times the alarm float in the flow equalization tank is activated.
- (d) An annual inspection shall be performed by a designer during April or May of each year; and a report from the annual inspection shall be submitted to the Secretary by July 1 of the year of the inspection, which includes:
 - (1) the recorded daily meter readings and an analysis of the daily water meters to determine if any adjustment to the sizing of the wastewater system is needed; and
 - (2) a description of whether there is a need for changes to the pump station float settings based on the daily flow and dose cycle for the wastewater system.

Note: Examples for designing a flow equalization tank are included in Appendix B, Examples B-1.

§ 1-917 In-ground Trenches and Trenches in Mounds

- (a) An in-ground trench or a trench in a mound shall be sized according to the following requirements:
 - (1) Trenches shall have a maximum width of 48 inches.
 - (2) The minimum required square footage shall be calculated using the formula $TA = DF \div AR$ where:
 - (A) TA is the minimum required bottom trench area in square feet;
 - (B) DF is the design flow in gallons per day; and
 - (C) AR is the application rate in gallons per day per square foot identified in § 1-911.
 - (3) When the minimum linear loading rate is calculated, the minimum length of a trench shall equal the length derived by dividing the DF by the linear loading rate.
 - (4) Where the depth of leachfield stone exceeds 12 inches below the distribution pipe, the size of a trench calculated pursuant to Subsection (a)(2) may be reduced to the percentage indicated in Table 9-5, except for:
 - (A) trenches that do not use leachfield stone;
 - (B) trenches in leachfields disposing of filtrate effluent that are designed in accordance with § 1-904(a);
 - (C) trenches in mounds;
 - (D) innovative and alternative dispersal systems; and
 - (E) systems designed to dispose of high strength wastewater that do not include pre-treatment to reduce the BOD₅ and TSS to low strength.

**Table 9-5
Percentage of Standard Trench Leachfield Area Required**

Depth of Leachfield Stone Below Distribution Pipe	Trench Width 12 inches	Trench Width 18 inches	Trench Width 24 inches	Trench Width 36 inches	Trench Width 48 inches
18 inches	60%	64%	66%	71%	75%
24 inches (max)	50%	54%	57%	62%	66%

- (b) The design of an in-ground trench or a trench in a mound shall meet the following additional requirements:
- (1) Trenches shall not be constructed in fill material except when trenches are constructed in mounds or constructed pursuant to the requirements in § 1-919.
 - (2) Trenches in mounds shall be horizontally separated by at least 4 feet of fill material.
 - (3) In-ground trenches shall be horizontally separated by at least 4 feet of naturally occurring soil.
 - (4) The bottom of each trench shall be level.
 - (5) Trenches shall have one of the following designs:
 - (A) Leachfield stone that complies with the following requirements:
 - (i) Leachfield stone shall extend a minimum of 2 inches above the distribution pipe and either:
 - (I) 12 inches below the distribution pipe; or
 - (II) 6 inches below the distribution pipe if the trench design uses the application rate for beds.
 - (ii) A layer of filter fabric shall be placed over the top of the leachfield stone.
 - (B) Prefabricated chambers that have a minimum H-10 structural loading rating and are laid level in the trench.
 - (C) Subsurface drip distribution that complies with § 1-923.
- (c) The design of an in-ground trench shall meet the following additional requirements:
- (1) A primary in-ground leachfield with trenches shall be at least 10 feet from a replacement in-ground leachfield with trenches, unless the trenches of the primary in-ground leachfield are interfingered with the trenches of the replacement in-ground leachfield.
 - (2) When the number of primary trenches does not equal the number of replacement trenches, the design shall maximize the number of primary and replacement trenches that are interfingered.
 - (3) In-ground trenches shall not be constructed in soil that have a soil texture of sandy clay, silty clay, or clay.
 - (4) The design of an in-ground trench shall comply with § 1-919(b) when the soil has a soil texture of very coarse sand or coarser.
 - (5) The bottom of any portion of the leachfield or other infiltrative surface shall be no greater than 36 inches below ground surface.
 - (6) The distribution piping shall be:

- (A) 4-inch rigid perforated pipe that is laid level;
 - (B) when chambers are used, 4-inch rigid perforated pipe; or
 - (C) when the wastewater system is designed to use pressure distribution, piping sized appropriately to achieve the requirements § 1-914.
- (7) The ends of all pipes must be capped except pipes that are laid at the same elevation may be connected.
 - (8) When the design of the in-ground trench does not use pressure distribution and the design includes multiple trenches, a distribution box shall be part of the design and shall be:
 - (A) equipped with flow equalization devices for each distribution pipe that can be adjusted to maintain equal distribution;
 - (B) designed with an at-grade access; and
 - (C) protected against freezing.
 - (9) Any length of pipe within an in-ground trench that exceeds 100 feet in length shall be dosed pursuant to the requirements of § 1-914.
 - (10) In-ground trenches shall extend a minimum of 6 inches, or the required depth of the leachfield stone below the distribution pipe, whichever is greater, below ground surface on the downslope edge of the trench when constructed in naturally occurring soil.
 - (11) The bottom of an in-ground trench shall extend no deeper than 36 inches below ground surface. When the trench is constructed in naturally occurring soil and on a sloping site, the vertical measurements shall be taken from the deepest portion of the trench below the surface of the naturally occurring soil.
 - (12) Each in-ground trench shall be covered with a minimum of 6 inches and a maximum of 12 inches of permeable soil, the top 2 to 4 inches of which shall be topsoil.
- (d) The construction of an in-ground trench or a trench in a mound shall meet the following requirements:
 - (1) Construction shall not occur if a sample of soil obtained from approximately 8 inches below the surface can be easily rolled into a wire. This indicates the soil moisture content is too high for construction purposes.
 - (2) After excavation of each trench, any smeared surface of the trench area including sidewalls shall be scarified with a rake.
 - (3) To prevent undesirable compaction of the scarified soil, construction equipment not needed to construct the leachfield shall be kept off the leachfield area.
 - (e) During operation of distribution boxes:
 - (1) Flow equalization devices shall periodically be adjusted to maintain equal distribution.
 - (2) Settled solids shall periodically be removed to prevent passage of solids to downstream components.

§ 1-918 In-ground Beds and Beds in Mounds and Beds in Bottomless Sand Filters

- (a) An in-ground bed, a bed in a mound, or a bed in a bottomless sand filter shall be sized according to the following requirements:

- (1) The minimum required square footage shall be calculated using the formula $BA = DF \div AR$ where:
 - (A) BA is the minimum required bed area in square feet;
 - (B) DF is the design flow in gallons per day; and
 - (C) AR is the application rate in gallons per day per square foot identified in § 1-911.
 - (2) When the minimum linear loading rate is calculated, the minimum length of a bed shall equal the length derived by dividing the DF by the linear loading rate.
- (b) The design of an in-ground bed, a bed in a mound, or a bed in a bottomless sand filter shall meet the following additional requirements:
- (1) Beds shall not be constructed in fill material except when beds are constructed in mounds or bottomless sand filters.
 - (2) The bottom of a bed shall be level.
 - (3) Beds in mounds shall be horizontally separated by at least 10 feet of fill material.
 - (4) In-ground beds shall be horizontally separated by at least 10 feet of naturally occurring soil.
 - (5) All distribution pipes within the bed shall be uniformly spaced no more than 6 feet apart.
 - (6) The maximum distance from a distribution pipe and the edge of the bed shall be 3 feet.
 - (7) Beds shall have one of the following designs:
 - (A) Leachfield stone that complies with the following requirements:
 - (i) Leachfield stone shall extend a minimum of 2 inches above the distribution pipe and 6 inches below the distribution pipe.
 - (ii) A layer of filter fabric shall be placed over the top of the leachfield stone.
 - (B) Prefabricated chambers that have a minimum H-10 structural loading rating that are laid level in the bed.
 - (C) Subsurface drip distribution that complies with § 1-923.
 - (8) The maximum capacity for any single bed is 2000 gallons per day.
- (c) In-ground beds shall meet the following additional requirements:
- (1) In-ground beds shall not be constructed in soil that have a soil texture of sandy clay, silty clay or clay.
 - (2) The design of an in-ground bed shall comply with § 1-919(b) when the soil has a soil texture of very coarse sand or coarser.
 - (3) The bottom of any portion of the leachfield or other infiltrative surface shall be no greater than 36 inches below ground surface.
 - (4) When the design of the in-ground bed does not use pressure distribution, a distribution box shall be part of the design and shall be:
 - (A) equipped with flow equalization devices for each distribution pipe that can be adjusted to maintain equal distribution;
 - (B) designed with an at-grade access; and
 - (C) protected against freezing.
 - (5) When the design of the in-ground bed does not use pressure distribution and the design includes multiple beds, a distribution box that complies with Subsection

- (c)(4) shall be part of the design to equally distribute effluent to each distribution box serving each bed.
- (6) The distribution piping shall be:
 - (A) 4-inch rigid perforated pipe that is laid level;
 - (B) when chambers are used, 4-inch rigid perforated pipe; or
 - (C) when the wastewater system is designed to use pressure distribution, piping sized appropriately to achieve the requirements § 1-914.
 - (7) The ends of all pipes must be capped except pipes that are laid at the same elevation may be connected.
 - (8) Any length of pipe within an in-ground bed that exceeds 100 feet in length shall be dosed pursuant to the requirements of § 1-914.
 - (9) In-ground beds shall extend a minimum of 6 inches, or the required depth of the leachfield stone below the distribution piping, whichever is greater, below ground surface.
 - (10) The bottom of a portion of an in-ground bed shall extend no deeper than 36 inches below ground surface. On a site that has a slope, the vertical measurements shall be taken from the deepest portion of the bed below the surface of the naturally occurring soil.
 - (11) Each in-ground bed shall be covered with a minimum of 6 inches and a maximum of 12 inches of permeable soil, the top 2 to 4 inches of which shall be topsoil.
- (d) The construction of an in-ground bed, bed in a mound, and bed in a bottomless sand filter shall meet the following requirements:
- (1) Construction shall not occur if a sample of soil obtained from approximately 8 inches below the surface can be easily rolled into a wire. This indicates the soil moisture content is too high for construction purposes.
 - (2) After excavation of the bed, any smeared surfaces of the bed area, including sidewalls, shall be scarified with a rake.
 - (3) To prevent undesirable compaction of the scarified soil, construction equipment not needed to construct the leachfield shall be kept off the leachfield area.
- (e) During operation of distribution boxes:
- (1) Flow equalization devices shall periodically be adjusted to maintain equal distribution.
 - (2) Settled solids shall periodically be removed to prevent passage of solids to downstream components.

§ 1-919 Additional Design Requirements for In-Ground Leachfields

- (a) Except as provided in Subsection (d), in-ground leachfields shall be located on sites that comply with the depths of naturally occurring soil required pursuant to § 1-903(i) and any additional requirements in this Section.
- (b) For sites where the soil that will be directly beneath the proposed infiltrative surface of an in-ground leachfield has a soil texture of very coarse sand or coarser, and there is no soil with a thickness of 1 foot or greater with a soil texture of coarse sand or finer between the bottom of the proposed infiltrative surface of the leachfield and the seasonal high groundwater table or bedrock:

- (1) The in-ground leachfield shall be a trench or bed with a minimum of 12 inches and a maximum of 18 inches of fill material meeting the specifications in § 1-921(g) placed below the bottom of the leachfield stone, piping for subsurface drip distribution, or other infiltrative surface.
- (2) Notwithstanding § 1-911(c), the maximum application rate for sizing the in-ground leachfield shall be 1.0 gallon per square foot per day.

Note: An alternative to constructing an in-ground leachfield in conformance with Subsection (b) is to construct the leachfield in a mound in compliance with these Rules.

- (c) For sites with 42 inches or greater depths of soil required pursuant to § 1-903 (i.e., complying soil), over a soil with redoximorphic features, with indicators of seasonal high-water table, with a texture of silt loam, silt, sandy clay loam, clay loam, silty clay loam, sandy clay, silty clay, or clay (i.e., limiting soil), and 54 inches or greater depths of soil required pursuant to § 1-903 over bedrock, an in-ground leachfield shall meet the following requirements.
 - (1) The required depth of leachfield stone below the distribution pipe as required for an in-ground trench or bed shall be located entirely in naturally occurring soil that complies with § 1-903.
 - (2) If the design of the leachfield uses subsurface drip distribution that is in a trench or bed that does not use leachfield stone below the bottom of the drip distribution pipe, the drip distribution pipe shall be located entirely on naturally occurring soil that complies with § 1-903.
 - (3) The maximum application rate for sizing the in-ground leachfield that uses leachfield stone shall be based on the complying soil above the limiting soil.
 - (4) Naturally occurring soil from the site is suitable to cover the leachfield stone, but the top 2 to 4 inches of the cover shall be topsoil.

Note: Appendix C, Figure C-6, depicts a detail of a typical shallow trench wastewater system.

- (d) For sites with soil with redoximorphic features, with indicators of seasonal high-water table, with a texture of silt loam, silt, sandy clay loam, clay loam, silty clay loam, sandy clay, silty clay, or clay (i.e., limiting soil), and where the limiting soil terminates 24 inches or less below ground surface, provided the soil below the limiting soil comply with the depths of naturally occurring soil required pursuant to § 1-903 (i.e., complying soil), the in-ground leachfield shall meet the following requirements.
 - (1) The required depth of leachfield stone below the distribution pipe as required for an in-ground trench or bed shall be located entirely in naturally occurring soil that complies with § 1-903.
 - (2) If the design of the leachfield uses subsurface drip distribution that is in a trench or bed that does not use leachfield stone below the bottom of the drip distribution pipe, the drip distribution pipe shall be located entirely on naturally occurring soil that complies with § 1-903.
 - (3) The maximum application rate for sizing the in-ground leachfield that uses leachfield stone shall be based on the complying soil below the limiting soil.
 - (4) For sites where there is a soil directly beneath the infiltrative surface of an in-ground leachfield with a soil texture of coarse sand or sand, and the design of the leachfield uses leachfield stone below the distribution pipes, or the design is a

subsurface drip distribution with less than 1 foot of fill below the distribution line, the design shall comply with Subsection (b)(1).

- (5) A stormwater diversion swale to divert stormwater away from the leachfield shall be located upslope of the leachfield with the bottom of the drain or swale cut into, but not through, the soil with redoximorphic features.

Note: Appendix C, Figure C-7, depicts a detail of a typical trench wastewater system with 24 inches of limiting soil.

- (e) For sites with soil with redoximorphic features, with indicators of seasonal high-water table, with a texture of silt loam, silt, sandy clay loam, clay loam, silty clay loam, sandy clay, silty clay, or clay (i.e., limiting soil), and where the limiting soil terminates 5 feet or less below ground surface, the in-ground leachfield shall meet the following requirements:
 - (1) The in-ground leachfield shall be designed using pressure distribution.
 - (2) Notwithstanding § 1-911(c), the maximum application rate for sizing the in-ground leachfield shall be 1.0 gallon per square foot per day.
 - (3) Except as provided in Subsection (e)(5), the required depths of naturally occurring soil for the in-ground leachfield shall be:
 - (A) The minimum depth of naturally occurring soil (i.e., complying soil) below the limiting soil shall be:
 - (i) 24 inches to the seasonal high-water table;
 - (ii) 24 inches to a soil with a texture of silt loam, silt, sandy clay loam, clay loam, silty clay loam, sandy clay, silty clay, or clay; and
 - (iii) 24 inches to bedrock.
 - (B) The minimum depth of the naturally occurring soil below the limiting soil shall be met for a distance of:
 - (i) 25 feet in the downslope direction beyond the limits of the excavation for the leachfield; and
 - (ii) 10 feet on all other sides, beyond the limits of the excavation for the leachfield.
 - (C) The depth of fill material below the bottom of the leachfield stone or other infiltrative surface of the leachfield shall be sufficient to obtain the following vertical separations:
 - (i) 36 inches to the seasonal high-water table;
 - (ii) 36 inches to a soil with a texture of sandy clay, silty clay, or clay; and
 - (iii) 48 inches to bedrock.
 - (4) For an in-ground leachfield with a design flow of 1000 gallons per day or more, a hydrogeological analysis shall be completed that demonstrates the induced water table is a minimum of:
 - (A) 6 inches below the bottom of the limiting soil; and
 - (B) 36 inches below the bottom of the leachfield stone or other infiltrative surface of the leachfield.
 - (5) Notwithstanding Subsection (e)(3), when the in-ground leachfield disposes of filtrate effluent and is designed in accordance with § 1-904(a):
 - (A) The minimum depth of naturally occurring soil (i.e., complying soil) below the limiting soil shall be:

- (i) 18 inches to a soil that has a texture of sandy clay, silty clay, or clay; and
 - (ii) 18 inches to bedrock.
 - (B) The depth of fill material below the bottom of the leachfield stone or other infiltrative surface of the leachfield shall be sufficient to obtain the following vertical separations:
 - (i) 18 inches to the induced water table, as demonstrated through a hydrogeological analysis;
 - (ii) 18 inches to a soil with a texture of sandy clay, silty clay, or clay; and
 - (iii) 24 inches to bedrock.
- (2) The limiting soil shall be removed to the depth of the complying soil and replaced with fill material that meets the specifications in § 1-921(g) and:
 - (A) The complying soil shall be scarified prior to placement of the fill material.
 - (B) The fill material shall extend a minimum of 1 foot beyond the outside edge of the leachfield stone or other infiltrative surface of the in-ground trench or bed.
 - (C) The fill material shall extend at least 1 foot beyond the outside area of the calculated actual wetted area around the emitters when the design of the leachfield uses subsurface drip distribution that is not in a trench or bed and does not use leachfield stone as the infiltrative surface.
- (3) A curtain drain or drainage swale to divert groundwater and stormwater away from the leachfield area shall be installed up-slope of the leachfield. The bottom of the drain or swale shall cut into the limiting soil but shall be no deeper than 80 percent of the limiting soil.

Note: Appendix C, Figure C-8, depicts a detail of a typical trench wastewater system with 24 inches to 5 feet of limiting soil.

§ 1-920 At-grade Leachfields

- (a) For the purposes of this Section, “effective infiltration area” means the area of naturally occurring soil upon which at least 6 inches of leachfield stone is placed. It does not include:
 - (1) the downslope area of the leachfield stone that is less than 6 inches thick;
 - (2) the side slope fill areas; or
 - (3) the portion of the leachfield stone that is upslope of the distribution pipe on sites with a slope of greater than 3 percent.
- (b) A Class 1, Class B, or Class BW designer is required to submit the installation certification required pursuant to § 1-311(b) for the installation of an at-grade leachfield.
- (c) At-grade leachfields shall be located on sites that comply with the following requirements:
 - (1) At-grade leachfields shall be located on sites that comply with the depths of naturally occurring soil required pursuant to § 1-903(i).

- (2) At-grade leachfields shall not be constructed on soil with a soil texture of very coarse sand or coarser, unless there is soil with a thickness of 1 foot or greater with a soil texture of coarse sand or finer between the bottom of the proposed infiltrative surface of the leachfield and the seasonal high groundwater table or bedrock.
- (d) An at-grade leachfield shall be sized according to the following requirements:
- (1) The minimum required square footage shall be calculated using the formula $BA = DF \div AR$ where:
 - (A) BA is the minimum required stone area in square feet;
 - (B) DF is the design flow in gallons per day; and
 - (C) AR is the application rate in gallons per day per square foot identified in § 1-911 or Subsection (e)(2).
 - (2) When the minimum linear loading rate is calculated, the minimum length of a leachfield shall equal the length derived by dividing the DF by the linear loading rate.
 - (3) When tree stumps or boulders are left in place within the area for the leachfield, the size of the leachfield and replacement area shall be increased approximately equal to the percentage of soil surface lost due to tree stumps or boulders.
- (e) At-grade leachfields can be located on an area that has non-naturally occurring soil over naturally occurring soil, provided the site complies with Subsection (c) and the following:
- (1) The non-naturally occurring soil:
 - (A) is clean mineral soil free of wood, leaves, and other debris;
 - (B) does not have a soil texture of silt loam, silt, sandy clay loam, clay loam, silty clay loam, sandy clay, silty clay, or clay;
 - (C) will not cause horizontal flows that could lead to surfacing of the effluent; and
 - (D) is of sufficient size and consistency to place an at-grade leachfield.
 - (2) The maximum application rate for sizing the at-grade leachfield shall be determined based on Table 9-2 using the texture and structure of the non-naturally occurring soil, or the most limiting naturally occurring soil texture and structure identified within 0 to 3 feet below the non-naturally occurring soil, identified from soil excavations, whichever results in the lower application rate. ~~;~~
- (f) The design of an at-grade leachfield shall meet the following requirements:
- (1) When an at-grade leachfield has two or more infiltrative surfaces placed end to end, the infiltrative areas shall be separated a minimum of 10 feet as measured from the edge of the leachfield stone.
 - (2) When an at-grade leachfield has two or more infiltrative areas placed in the same flow path, the infiltrative areas shall:
 - (A) be separated a minimum of 6 feet as measured from the edge of the leachfield stone; and
 - (B) comply with § 1-903(i)(4)(A) from the most downslope infiltrative area.
 - (3) The infiltrative areas of a primary at-grade leachfield and a replacement at-grade leachfield may interfinger provided:

- (A) there is maintained a minimum of 6 feet of naturally occurring soil between infiltrative areas as measured from the edge of the fill material over each infiltrative area; and
 - (B) the infiltrative areas comply with § 1-903(i)(4)(A) from the most downslope infiltrative area.
- (4) When a primary at-grade leachfield and a replacement at-grade leachfield are placed in the same flow path but the infiltrative areas of the primary at-grade leachfield and the replacement at-grade leachfield are not interfingered, the primary at-grade leachfield and replacement at-grade leachfield shall be separated by 10 feet of naturally occurring soil measured from the edge of the fill material for the primary and replacement at-grade leachfields.
- (5) Notwithstanding Subsection (f)(1), (2), (3) and (4), when the primary and replacement at-grade leachfields are designed on an area that has non-naturally occurring soil over naturally occurring soil pursuant to Subsection (e), there shall be an equal distance of undisturbed non-naturally occurring soil between infiltrative areas as would be required for naturally occurring soil pursuant to § 1-903(i)(4).
- (6) At-grade leachfields shall utilize pressure distribution pursuant to § 1-914.
- (7) At-grade leachfields receiving 3000 gallons per day or more of design flow shall consist of dual alternating at-grade leachfields.
- (8) The maximum width of the effective infiltration area shall be 6 feet.
- (9) The minimum width of the effective infiltration area shall be 3 feet.
- (10) A minimum length to width ratio of 2 to 1 shall be provided for at-grade leachfields.
- (A) The system length and width shall be determined by measuring from the outer edges from the 6-inch depth of the leachfield stone.
 - (B) The width dimension includes the separation distance (6 feet minimum) between individual infiltration areas for at-grade leachfields having more than one infiltration area.
 - (C) The width does not include the 2 feet of leachfield stone upslope from the distribution pipe for at-grade leachfields on a slope of greater than 3 percent.
- (11) Force mains shall connect to the distribution pipe from:
- (A) the ends of the leachfield; or
 - (B) from the upslope side of the leachfield.
- (12) The distribution pipe shall:
- (A) be placed in the center of the effective infiltration area on sites with less than or equal to a 3 percent slope; and
 - (B) placed at the upper side of the effective infiltration area on sites with a slope that is greater than 3 percent.
- (13) A minimum of 6 inches of leachfield stone shall be placed under the distribution pipe and at least 2 inches of leachfield stone shall be placed above the top of the distribution pipe.
- (14) Filter fabric shall be placed over the top of the leachfield stone. The leachfield stone shall be covered with a minimum of 12 inches of permeable fill material, with a maximum of 18 inches of soil, the top 2 to 4 inches of which shall be topsoil and the remainder a fine sandy loam to medium sand texture.

- (15) All four sides of the fill material shall be designed to slope away at a pitch that is not steeper than 1-foot rise for every 3-foot run.
 - (16) The design shall indicate that a vegetated cover shall be maintained over all portions of the system.
 - (17) A swale shall be designed, or the area surrounding the at-grade leachfield shall be graded, to divert stormwater away from the at-grade.
- (g) The construction of an at-grade leachfield shall meet the following requirements:
- (1) The stormwater diversion swale, if part of the design, shall be installed prior to constructing the at-grade leachfield to keep stormwater away from the system while it is under construction.
 - (2) Construction shall not occur if a sample of soil obtained from approximately 8 inches below the surface can be easily rolled into a wire. This indicates the soil moisture content is too high for construction purposes.
 - (3) To prevent compaction, construction equipment shall not move across the plowed or tilled surface or the effluent dispersal area for a distance of 25 feet downslope of the fill material except for equipment required for placing the leachfield stone or fill material.
 - (4) Vegetation shall be cut close to the ground and removed from the area to be plowed or tilled.
 - (5) Tree stumps shall be cut flush with the ground and the roots left in place.
 - (6) On wooded sites, the forest litter shall be raked off the infiltrative area if more than an inch thick.
 - (7) The infiltrative area for an at-grade leachfield and the area beneath the non-naturally occurring soil shall be plowed, preferably by mold board or chisel plow, to a depth of 6 to 8 inches, parallel to the ground contour. If the site cannot be plowed, a backhoe bucket fitted with chisel teeth may be used to “till” the site by creating furrows that are parallel to the ground contours.
 - (8) During plowing, the soil shall be thrown downslope to provide a proper interface between the soil and the leachfield stone.
 - (9) The force main may be installed before or after plowing or tilling.
 - (10) Construction shall begin immediately after the plowing or tilling by placing the leachfield stone.
 - (11) Upon completion of the distribution piping, pressure test the system with clean water.
 - (12) After successful testing of the distribution piping, the distribution pipe shall be covered with at least 2 inches of clean leachfield stone.
 - (13) The leachfield stone shall be covered completely with filter fabric.
 - (14) The filter fabric shall be covered with a minimum of 12 inches but not more than 18 inches of soil, the top 2 to 4 inches of which must be topsoil and the remainder a fine sandy loam to medium sand texture.
 - (15) The entire at-grade leachfield shall be seeded and mulched or sodded to assure stability of the installation.
 - (16) The area surrounding the at-grade leachfield shall be graded to divert stormwater away from the at-grade leachfield.

Note: Appendix C, Figure C-9, depicts a detail of a typical at-grade leachfield with one infiltration area (0-3 % site slope). Figure C-10, depicts a detail of a typical at-grade leachfield

with two infiltration areas (> 3 % site slope). Appendix C, Figure C-11, depicts a detail of a typical at-grade leachfield with interfingering infiltration areas (> 3 % site slope).

§ 1-921 Leachfields in Mounds

- (a) A Class 1, Class B, or Class BW designer is required to submit the installation certification required pursuant to § 1-311(b) for the installation of a leachfield in a mound.
- (b) Leachfields in mounds shall be located on sites that comply with the depths of naturally occurring soil required pursuant to § 1-903.
- (c) The design of a leachfield in a mound may rely on curtain drains to lower the seasonal high-water table to 24 inches or more in order to comply with § 1-903(j) without complying with the requirements of § 1-906(a) when:
 - (1) the leachfield disposes of 600 gallons or less per day of effluent;
 - (2) the leachfield is sited on ground which has a slope;
 - (3) the leachfield consists of a maximum of either 2 trenches or a bed that has a maximum width of 10 feet;
 - (4) the seasonal high-water table is 18 inches or more below the naturally occurring soil prior to use of the curtain drain;
 - (5) the bottom of the curtain drain is designed to be a minimum of 12 inches into the soil with a texture of silt loam, silt, sandy clay loam, clay loam, silty clay loam, sandy clay, clay, and silty clay;
 - (6) any hydrogeological analysis performed for the leachfield is based on an assumed seasonal high-water table of 18 inches below the ground surface; and
 - (7) the Secretary agrees the curtain drain will lower the seasonal high-water table to 24 inches or more.
- (d) A leachfield in a mound shall be one of the following:
 - (1) a trench provided, when there are 2 or more trenches:
 - (A) for designs not including a hydrogeological analysis, the minimum trench length shall be twice the width across the top of the mound as measured from the outside to outside of the trenches; or
 - (B) for designs including a hydrogeological analysis, the trench length equals or exceeds the combined width of the trenches; or
 - (2) a bed, provided the bed has a maximum width of 10 feet and the bed length equals or exceeds the bed width.
- (e) Leachfields in mounds shall be sized according to the following requirements:
 - (1) Trenches shall be sized according to the requirements of § 1-917(a).
 - (2) Beds shall be sized according to the requirements of § 1-918(a).
 - (3) When tree stumps or boulders are left in place within the area for the leachfield, the size of the leachfield shall be increased approximately equal to the percentage of soil surface lost due to tree stumps or boulders.
- (f) Leachfields in mounds can be located on an area that has non-naturally occurring soil over naturally occurring soil, provided:

- (1) The non-naturally occurring soil:
 - (A) is clean mineral soil free of wood, leaves, and other debris;
 - (B) does not have a soil texture of sandy clay, silty clay, or clay;
 - (C) will not cause horizontal flows that could lead to surfacing of the effluent; and
 - (D) is of sufficient size and consistency to place a mound;
 - (2) The maximum application rate for sizing the effective basal area shall be 1 gallon per square foot or determined using Table 9-2, using the texture and structure of the non-naturally occurring soil, or the most limiting naturally occurring soil texture and structure identified within 0 to 2 feet below the non-naturally occurring soil identified from soil excavations, whichever results in the lower application rate.
 - (3) The design includes a minimum of 12 inches of mound fill above the non-naturally occurring soil.
- (g) The fill material to be used in a mound shall meet the following requirements:
- (1) The mound fill material from the plowed ground surface, or the top of the non-naturally occurring soil identified in Subsection (f), to the top of the trench or bed in the mound fill material shall be clean silica sand meeting the sieve requirements in Table 9-6, Table 9-7, or Table 9-8. Interpolation of any fill analyses is not permitted.

**Table 9-6
Mound Fill Material #1**

Sieve Number	Opening (mm)	Percent Passing, by Weight
3/8	9.500	85 - 100
40	0.420	25 - 75
60	0.240	0 - 30
100	0.149	0 - 10
200	0.074	0 - 5

**Table 9-7
Mound Fill Material #2¹**

Sieve Number	Opening (mm)	Percent Passing, by Weight
4	4.750	95 - 100
8	2.380	80 - 100
16	1.190	50 - 85
30	0.590	25 - 60
50	0.297	10 - 30
100	0.149	2 - 10

¹ Mound Fill Material #2 is ASTM Specification C 33 and is intended for manufactured material.

**Table 9-8
Mound Fill Material #3**

Sieve Number	Opening (mm)	Percent Passing, by Weight
3/8	9.500	85 - 100
40	0.420	30 - 50
200	0.074	0 - 5

- (2) The Secretary may approve other fill material that is proposed by the designer when the designer submits information demonstrating that the fill material will provide the same treatment of effluent as using the mound fill material identified in Subsection (g)(1) and will provide the same life expectancy for a mound as using the mound fill material identified in Subsection (g)(1).
 - (3) Notwithstanding any condition in a permit issued under the September 10, 1982 Environmental Protection Rules authorizing a leachfield in a mound requiring the use of fill material that differs from the mound fill material identified in Subsection (g)(1), a wastewater system not yet constructed pursuant to the permit may use the mound fill material identified in Subsection (g)(1).
- (h) The effective basal area for a mound shall be sized according to one of the following methods:
- (1) The minimum required square footage calculated using the formula $EBA = DF \div AR$ where:
 - (A) EBA is the minimum required square footage of effective basal area in square feet;
 - (B) DF is the design flow in gallons per day; and
 - (C) AR is the maximum application rate in gallons per day per square foot identified in Subsection (i) or (f)(2).
 - (2) The minimum required square footage determined through a hydrogeological analysis, but in no case less than that equal to the length and width required for the leachfield pursuant to these Rules.
- (i) Except where Subsection (f)(2) applies, the maximum application rate for sizing the effective basal area shall be:
- (1) 0.74 gallons per day per square foot when it is determined through soil excavations that the most limiting naturally occurring soil texture and structure identified within 0 to 2 feet below the ground surface has soil textures of coarse sand, sand, fine sand, very fine sand, sand, loamy coarse sand, loamy sand, loamy fine sand, loamy very fine sand, coarse sandy loam, sandy loam, fine sandy loam, very fine sandy loam, and loam.
 - (2) 0.24 gallons per day per square foot when it is determined through soil excavations that the most limiting naturally occurring soil texture and structure identified within 0 to 2 feet below the ground surface has soil textures of silt loam, silt, sandy clay loam, clay loam, silty clay loam.
- (j) The design of a mound shall meet the following requirements:
- (1) There shall be a minimum of 1 foot of mound fill material between the bottom elevation of the leachfield and the naturally occurring soil.
 - (2) The mound fill material shall extend a minimum of 1 foot beyond the effective basal area.

- (3) Mounds shall utilize pressure distribution pursuant to § 1-914.
 - (4) Mounds shall be designed with the long dimension of the system parallel to the land contour.
 - (5) Force mains shall connect to the distribution pipe in the leachfield from:
 - (A) the ends of the leachfield in the mound; or
 - (B) from the upslope side of the leachfield in the mound.
 - (6) The area of mound fill material shall be sufficient to extend 1 foot beyond the edge of the required trenches or the bed before the sides are shaped to the acceptable slope.
 - (7) The maximum acceptable side slope for mounds shall be:
 - (A) 1-foot rise for every 3-foot run; or
 - (B) 1-foot rise for every 2-foot run when the design:
 - (i) includes instructions for construction; and
 - (ii) includes one of the following erosion prevention design measures to protect side slope stability following seeding or sodding:
 - (I) placing rolled erosion control product along the entire side slopes; or
 - (II) other erosion prevention measures acceptable to the Secretary.
 - (8) A swale shall be designed, or the area surrounding the mound shall be graded, to divert stormwater away from the mound.
 - (9) The area 25 feet downgradient of the mound, as measured from the edge of the mound fill material, is the effluent dispersal area and shall not be disturbed by removal of soil or any development, including building construction, swimming pools, roadways, and parking areas.
- (k) The construction of a mound shall meet the following requirements:
- (1) Vegetation shall be closely cut and removed from the ground surface throughout the area to be used for the placement of the mound fill material. Tree stumps shall be cut flush with the surface of the ground and roots shall not be pulled.
 - (2) Construction shall not occur if a sample of soil obtained from approximately 8 inches below the surface can be easily rolled into a wire. This indicates the soil moisture content is too high for construction purposes.
 - (3) The area shall be plowed to a depth of 7 to 8 inches.
 - (4) If the site cannot be plowed, a backhoe bucket fitted with chisel teeth may be used to “till” the site by creating furrows that are parallel to the ground contours.
 - (5) To prevent compaction, construction equipment shall not move across the plowed or tilled surface or the effluent dispersal area for a distance of 25 feet downslope of the mound fill material except for equipment required for placing the mound fill material.
 - (6) Construction shall commence immediately after preparation of the soil interface by placing the mound fill material in a minimum of 6-inch lifts at which point construction equipment may drive over the mound fill material.
 - (7) After construction of the distribution system, but prior to covering the distribution system, the distribution system shall be pressure tested.
 - (8) After successful testing of the distribution system, any necessary additional leachfield stone and the filter fabric shall be installed and the system completed.

- (9) The entire mound shall be covered with topsoil native to the site, or of similar characteristics, to support vegetation found in the area.
- (10) The entire mound shall be covered with 12 inches of soil that is less permeable than the mound fill material with the top of the mound being covered. Naturally occurring soil from the site is normally suitable for cover material but the top 2 to 4 inches of the cover shall be topsoil.
- (11) The entire mound shall be seeded and mulched or sodded to assure stability of the installation.
- (12) Install the swale, or the area surrounding the mound shall be graded, to divert stormwater away from the mound.

Note: Appendix C, Figure C-12, depicts a detail of a typical bed in a mound.

§ 1-922 Leachfields in Bottomless Sand Filters

- (a) A Class 1, Class B, or Class BW designer is required to submit the installation certification for the installation of a leachfield in a bottomless sand filter and the results of all sieve analysis completed pursuant to Subsection (d).
- (b) Bottomless sand filters shall be located on sites that comply with the following requirements:
 - (1) Bottomless sand filters shall only be located on sites that comply with the depths of naturally occurring soil required pursuant to § 1-903.
 - (2) Bottomless sand filters shall not be located on sites with tree stumps or boulders.
- (c) A leachfield in a bottomless sand filter shall be a bed and shall be sized according to the requirements of § 1-918(a).
- (d) The fill material to be used in a bottomless sand filter shall meet the following requirements:
 - (1) The bottomless sand filter fill material from the plowed ground surface to the bottom of the cover stone in the filter shall be clean silica sand meeting the sieve requirements in Table 9-9.

**Table 9-9
Bottomless Sand Filter Fill Material**

Sieve Number	Opening (mm)	Percent Passing, by Weight
4	4.750	95 - 100
8	2.380	80 - 100
16	1.190	50 - 85
30	0.590	25 - 60
50	0.297	10 - 30
100	0.149	2 - 10
200	0.074	0 - 1

- (2) All bottomless sand filter fill material within the enclosure below the cover stone shall have:

- (A) an effective size (D₁₀) of 0.33 mm (+/-); and
 - (B) uniformity coefficient (D₆₀ ÷ D₁₀) of 3.0 to 4.0.
 - (i) Uniformity coefficient (U.C.) is a numeric quantity which is calculated by dividing the size of a sieve opening which will pass 60 percent by weight of a sand media sample by the size of the sieve opening which will pass 10 percent by weight of the same sand media sample. Note that 50 percent of the sample is retained between the two. The uniformity coefficient is a measure of the degree of size uniformity of the sand particles in a sand media sample. As the U.C. value approaches 1, the more uniform in particle size the sand media is. The larger the U.C., the less uniform the particle size.
 - (ii) U.C. = Particle Diameter 60 percent divided by Particle Diameter 10 percent (D₆₀ ÷ D₁₀).
 - (3) The designer shall complete at least one sieve analysis of the bottomless sand filter fill material as it is being installed to demonstrate compliance with the requirements of Subsections (d)(1) and (2). When the bottomless sand filter is designed to dispose of 1000 gallons per day or more, the Secretary may require additional sieve analyses to be taken from different sections of the bottomless sand filter.
- (e) The design of a leachfield in a bottomless sand filter shall meet the following requirements:
- (1) The design of a bottomless sand filter shall use time dosing that complies with § 1-915.
 - (2) When the design uses a subsurface drip distribution system:
 - (A) the laterals shall be placed on the stone or bottomless sand filter fill material; and
 - (B) the laterals shall have a maximum of 2 inches of sand that extends above the top of the lateral with stone to the required height above the lateral above the sand.
 - (3) The stone to be used in a bottomless sand filter shall meet the following requirements:
 - (A) Stone shall be 3/8-inch round or sub-rounded, screened or crushed, uniform in size so that no more than 5 percent of the sample is greater than ½ inch and no more than 5 percent shall pass a 3/8-inch sieve, not to be shale or other soft stone.
 - (B) Stone shall be double washed prior to placement on the bottomless sand filter fill material so it contains little or no fines.
 - (C) Total depth of the stone shall be 8 to 9 inches depending on the size of the lateral.
 - (4) Laterals within the bottomless sand filter shall provide lateral spacing and orifice spacing that:
 - (A) is as square as possible;
 - (B) has the liner approximately one half the lateral spacing to the closest lateral; and
 - (C) has a space between the ends of the laterals to the liner approximately equal to one half the orifice spacing that is able to accommodate the

fittings (i.e.: 45-degree elbow, threaded end adapter and cap). Regardless of the lateral spacing, there shall be sufficient space between the end of the lateral and liner for maintenance activities.

- (5) Orifices shall comply with § 1-914(d) except:
 - (A) there must be 2 orifices facing up spaced 1/3 and 2/3 respectively along each lateral;
 - (B) all other orifices must face down; and
 - (C) there must be a shield for all orifices. Shields for down facing holes shall contain slots or holes to provide free draining.

- (f) Pump stations used with a bottomless sand filter shall include pumps that meet one of the following requirements unless they are following an approved treatment unit:
 - (1) Pumps shall be housed in a screened basket and have an in-line effluent filter on the pump's discharge piping that is located accessible within the pump station.
 - (2) Pumps shall be designed in a manner that the Secretary concludes provides equal or greater protection as Subsection (f)(1) in preventing the passage of suspended solids to the leachfield.

- (g) Force mains used with a bottomless sand filter shall meet the following requirements:
 - (1) Force mains shall drain back to the pump station unless:
 - (A) the design provides insulation of the force main; or
 - (B) the force main is sufficiently deep to prevent freezing.
 - (2) Force mains shall connect to the distribution pipe in the leachfield from:
 - (A) the ends of the bottomless sand filter; or
 - (B) from the upslope side of the bottomless sand filter.

- (h) The design of the bottomless sand filter shall meet the following requirements:
 - (1) The maximum inside width of a bottomless sand filter shall be 10 feet.
 - (2) The area 25 feet downgradient of the bottomless sand filter, as measured from the edge of the enclosure, is the effluent dispersal area and shall not be disturbed by removal of soil or any development, including building construction, swimming pools, roadways, and parking areas.
 - (3) The effluent dispersal area may be plowed and covered with a maximum of 6 inches of soil, the top 2 to 4 inches of which shall be topsoil.
 - (4) Sod, vegetation, or dead or decaying organic litter or any organic soil horizon shall be removed from inside the footprint of the enclosure for the bottomless sand filter. Stripping of the topsoil layer under or outside the footprint for the bottomless sand filter is prohibited except as needed to lay the bottom of the enclosure level.
 - (5) The walls of bottomless sand filters must be lined with a 30-mil flexible PVC liner with all boots, patches, repairs, and seams having the same physical properties as the liner material. The designer shall inspect the liner as part of the installation certification to ensure all seams or tears of the liner were properly repaired and all boots are properly installed to prevent leakage of effluent through the side wall structure.
 - (6) The designer shall determine if the design needs to include insulation, such as foam board, inside the enclosure to prevent freezing within the enclosure.

- (7) The design shall identify the location and type of cross bracing to ensure structural integrity and prevent bowing of the sides of the enclosure. The Secretary may request a designer provide calculations to show where there needs to be cross bracing particularly when the total height of the bottomless sand filter exceeds 24 inches above finished grade.
 - (8) Stainless steel or galvanized rods may be used for cross bracing inside the bottomless sand filter to minimize bowing of the sides of the structure. The bolt heads and nuts holding the rods in place shall be recessed into the bottomless sand filter exterior structure to minimize risks of injury from sharp edges.
 - (9) Penetration through the PVC liner shall be done with a PVC boot attachment glued to the liner with appropriate resilient sealer.
 - (10) A permanent top frame structure (such as pressure treated 6 inch by 6-inch timbers, or other suitable structural support) must be provided on any portion of the above grade bottomless sand filter.
 - (11) The perimeter of the bottomless sand filter below the required minimal structural support may be bermed with naturally occurring soil or other material such as landscape stone or other non-degrading material. In areas where slope is a consideration, a concrete structure may be considered by the designer to minimize damage to the bottomless sand filter.
 - (12) A swale shall be designed, or the area surrounding the bottomless sand filter shall be graded, to divert stormwater away from the bottomless sand filter.
 - (13) One inspection well shall be installed in the approximate center of the filter that extends through the bottomless sand filter fill material terminating at the interface with the naturally occurring soil.
 - (14) Bottomless sand filters that have multiple zones shall have at least one inspection well per zone.
 - (15) The inspection well shall be PVC pipe (SDR 35 minimum) with a minimum diameter of 2 inches that is perforated or slotted, wrapped in filter fabric, and topped with a removable cap positioned slightly below the finished elevation of the cover stone.
 - (16) The area around the enclosure of the bottomless sand filter shall:
 - (A) extend level for a minimum horizontal isolation distance of 5 feet from the enclosure; and
 - (B) from each point 5 feet from the enclosure, be graded a minimum of 1-foot rise for every 3-foot run until the slope intersects the naturally occurring soil.
- (i) The construction of a bottomless sand filter shall meet the following requirements:
- (1) Construction shall not occur if a sample of soil obtained from approximately 8 inches below the surface can be easily rolled into a wire. This indicates the soil moisture content is too high for construction purposes.
 - (2) Excavation of naturally occurring soil beneath the bottomless sand filter is prohibited, except as required by Subsection (h)(3).
 - (3) Once the proper elevation for the base of the bottomless sand filter is reached, construct the enclosure of the bottomless sand filter.
 - (4) Upon completion of the enclosure, place 3 inches of the approved bottomless sand filter fill material in the enclosure and thoroughly mix with the upper 3 inches of the naturally occurring soil.

- (5) Placement of the remaining bottomless sand filter fill material to the necessary elevation shall be completed by:
 - (A) an excavator/backhoe bucket that is thoroughly washed prior to placement of the bottomless sand filter fill material to remove any soil in or on the bucket;
 - (B) placing the bottomless sand filter fill material in 8-inch lifts with the fill material wetted during installation to promote even settling (do not over wet the fill material as particle stratification may occur);
 - (C) using a hand rake or equivalent, to spread each 8-inch lift of bottomless sand filter fill material within the enclosure;
 - (D) “walking down” each 8-inch lift using only foot pressure by a person or persons wearing clean shoes free of soil with a texture of loam, silt loam, silt, sandy clay loam, clay loam, silty clay loam, sandy clay, silty clay, or clay (no compaction equipment shall be used); and
 - (E) inspecting each placement, wetting, and “walk down” of the fill material, by the installer or designer to be certain the filter liner is not stretched or punctured during the filling of the enclosure.
- (6) Placement of the stone over the bottomless sand filter fill material shall be as follows:
 - (A) place 3 inches of 3/8-inch stone over the fill material;
 - (B) place the laterals on the stone and pressure test the laterals;
 - (C) after successful testing of the distribution system, cover the laterals with stone or ¼ inch mesh plastic fabric;
 - (D) add a maximum of 6 inches of 3/8-inch stone over the lateral. If desired, place 1 to 2 inches of stone over the laterals, place a ¼ inch mesh plastic fabric over the top of the stone, and add the remaining stone over the fabric;
 - (E) maintain the top of the stone to prevent plants with roots that can penetrate more than 2 inches; and
 - (F) if desired, place bark mulch pellets to cover the stone or other material acceptable to the Secretary that will not limit the air movement into and out of the filter. Do not place topsoil over the stone.

Note: Appendix C, Figure C-13, depicts a detail of a typical leachfield in a bottomless sand filter.

§ 1-923 Leachfields Using Subsurface Drip Distribution

- (a) A Class 1, Class B, or Class BW designer is required to submit the installation certification for the installation of a wastewater system with subsurface drip distribution.
- (b) The use of subsurface drip distribution in the design of a wastewater system is optional.
- (c) General requirements for subsurface drip distribution
 - (1) A wastewater system using subsurface drip distribution shall be designed to dispose of filtrate effluent in accordance with § 1-904(a).
 - (2) The bottom of the drip line shall be:
 - (A) a minimum of 6 inches below finished ground surface when placed on naturally occurring soil;

- (B) a minimum of 6 inches into naturally occurring soil below ground surface or O soil horizon;
 - (C) a minimum of 6 inches below finished ground surface when used in place of leachfield stone and pipe for mounds; or
 - (D) placed on leachfield stone when used with designs using leachfield stone as the infiltrative area.
- (3) The required length of the subsurface drip distribution line shall be determined by:
- (A) the linear loading rate determined by a hydrogeological analysis;
 - (B) the soil application rate; and
 - (C) the actual wetted area around the drip emitters.
- (4) Designs of subsurface drip distribution shall:
- (A) use time dosing that complies with § 1-915;
 - (B) ensure that the system will function in all weather conditions;
 - (C) ensure that the transport and distribution piping within the systems be designed to “drain-back” to the pump station between dose cycles;
 - (D) specify the manufacturer of the piping, emitter, and pumping system (only one manufacturer may be specified per design);
 - (E) include the design, installation and maintenance instructions of the manufacturer; and
 - (F) include design calculations and details that demonstrate compliance with the manufacturer’s requirements and these Rules.
- (d) Subsurface drip distribution shall be constructed according to the following:
- (1) Subsurface drip distribution shall be installed, operated, and maintained in accordance with the current design, installation, and maintenance instruction of the manufacturer.
 - (2) Drip line, when placed in naturally occurring soil, shall be trenched by hand or with a trenching machine into narrow, shallow trenches or plowed (with a vibratory plow or other insertion tool) directly into the soil and backfilled without gravel or leachfield stone.
 - (3) After construction of the subsurface drip distribution, but prior to covering the distribution piping, a designer shall direct the testing of the distribution system.
 - (4) After successful testing of the distribution system, the distribution piping shall be covered.

Note: Appendix C, Figure C-14, depicts a detail of a typical leachfield using subsurface drip distribution.

§ 1-924 Intermittent and Recirculating Sand Filters

- (a) A Class 1, Class B, or Class BW designer is required to submit the installation certification required for the installation of wastewater system that includes an intermittent or recirculating sand filter.
- (b) The use of intermittent and recirculating sand filters in the design of a wastewater system is optional and may be proposed as a treatment component of a wastewater system.

- (1) The wastewater existing after filtration by an intermittent sand filter shall be presumed to be filtrate effluent when the septic tank effluent being discharged to the sand filter is low strength prior to filtration.
 - (2) The wastewater existing after filtration by a recirculating sand filter shall be presumed to be filtrate effluent when the septic tank effluent being discharged to the sand filter is low strength prior to filtration.
- (c) General requirements for intermittent and recirculating sand filters
- (1) Container Design & Construction
 - (A) The filter container shall be watertight to prevent groundwater from infiltrating into the filter container and to prevent wastewater exfiltration from the sand filter container. The container material shall be:
 - (i) reinforced concrete;
 - (ii) flexible membrane liner materials, provided they comply with the following requirements:
 - (I) they have properties that are at least equivalent to 30-mil un-reinforced polyvinyl chloride;
 - (II) they have field repair instructions and extra liner material that are provided to the purchaser with the liner;
 - (III) they have factory fabricated “boots” suitable for field bonding onto the liner to facilitate the passage of piping through the liner in a waterproof manner; and
 - (IV) they are compatible with the wastewater being treated; or
 - (iii) other materials having equivalent function, workmanship, watertightness and at least a 20-year service life.
 - (B) All tanks associated with a sand filter, including septic and dosing tanks and any pumping vaults, shall:
 - (i) be watertight;
 - (ii) have an at-grade access provided by a watertight manhole or riser not less than 18 inches in diameter, unless otherwise approved by the Secretary; and
 - (iii) be designed to prevent entry by children.
 - (C) Upon completion of installation of a sand filter, the recirculation tank and sand filter container shall be tested for watertightness by filling the recirculation tank and sand filter to a point at least 2 inches but not more than 3 inches above the point of riser connection to the top of the tank, chamber, or container. During the test, there shall not be a measurable leakage over a 24-hour period.
 - (D) Notwithstanding Subsection (c)(1)(C), the Secretary may approve other leakage testing methods.
 - (2) Siting Requirements
 - (A) The sand filters shall be protected from both groundwater and stormwater infiltration.
 - (B) For the purpose of determining the minimum isolation distance to other site features, the sand filter container shall comply with the isolation distances set forth in § 1-912 for septic tanks.
 - (3) Monitoring

- (A) The sand filter shall be designed for wastewater sample collection before and after the sand filter.
 - (B) The sand filter shall have the capability of measuring and recording the wastewater flow from buildings or structures or campgrounds to the sand filter.
- (4) Annual inspections of each sand filter by a Class 1, Class B, or Class BW designer are required. A written report shall be submitted to the Secretary within 30 days of the inspection. At a minimum, the following items shall be addressed in the inspection report:
- (A) use and age of system including the average daily flows;
 - (B) the recirculation ratio for recirculating sand filters;
 - (C) mechanical or electrical malfunctions;
 - (D) neglect or improper use; and
 - (E) flushing of the laterals.
- (5) Operation & Maintenance Manuals
- (A) A user's manual for the sand filter shall be developed or provided along with record drawing(s) at the time that the sand filter installation is complete. These manuals, at a minimum, shall contain the following information:
 - (i) diagrams of the components and their location;
 - (ii) an explanation of how the sand filter functions, operational expectations, and owner responsibility;
 - (iii) specifications of the electrical and mechanical components installed (occasionally components other than those specified on the plan and detail sheets are used);
 - (iv) names and telephone numbers of the designer, the local health authority, the supplier/installer, or the management entity to be contacted in the event of a failure;
 - (v) information on the periodic maintenance requirements of the sand filter, including the septic tank, the dosing and recirculating/mixing tanks, the sand filter unit, the pumps, the switches, the alarms, the leachfield, and other information as appropriate;
 - (vi) information on "trouble shooting" common operational problems that might occur. This information should be detailed and complete as needed to assist the system owner to make accurate decisions about when and how to attempt corrections of operational problems and when to call for professional assistance;
 - (vii) information on the disposal of discarded sand filter media in accord with state and local requirements; and
 - (viii) for proprietary sand filter units, a complete operation and maintenance document shall be developed and provided by the manufacturer. This document shall include all the appropriate items mentioned above plus any additional general and site-specific information useful to the system owner or the service provider.
- (d) Additional requirements for the design and construction of intermittent sand filters.
- (1) Underdrain System

- (A) The base of the sand filter container shall be level or constructed at a grade of 1 percent or less towards the underdrain piping.
 - (B) The underdrain piping shall be installed in the interior of the sand filter container at the lowest elevation. The piping shall be on a grade of 1 percent or less to the point of passage through the sand filter container.
 - (C) The underdrain piping and sand filter container bottom shall be covered with a minimum of 6 inches of clean washed ¾ inch to 1½ inch stone.
 - (D) Other types of underdrain systems may be proposed and approved after review by the Secretary.
- (2) Sand Filter Media
- (A) A minimum of 24 inches of approved sand filter soil media shall be placed over the underdrain system.
 - (B) The sand filter media shall be soil material meeting the sieve requirements in Table 9-10.

**Table 9-10
Intermittent Sand Filter Media**

Sieve Number	Opening (mm)	Percent Passing, by Weight
3/8	9.500	100
4	4.750	95 - 100
8	2.380	80 - 100
16	1.190	45 - 85
30	0.590	15 - 60
50	0.297	3 - 15
100	0.149	0 - 4

- (C) Other sand filter media may be proposed, provided a designer submits to the Secretary technical justification for the substitution of materials. The Secretary shall review and may approve the proposed substitution.
 - (D) The size of the sand filter shall be based on a maximum application rate of 1.25 gallons per day per square foot.
- (3) Distribution System
- (A) A pressurized distribution system shall be constructed in accord with the following requirements:
 - (i) above the sand filter media there shall be a minimum of 3 inches of washed, clean ¾ inch to 1½ inch stone below the distribution laterals, and sufficient stone above the laterals equal to or covering the orifice shields to provide a smooth even cover;
 - (ii) distribution laterals shall be spaced on maximum 30-inch centers. Orifices shall be placed such that there is at least one orifice for each 6 square feet of sand surface area;
 - (iii) the ends of the distribution laterals shall be designed and constructed with a means to perform flushing of the piping, collectively or individually, through the operation of a non-corroding and accessible valve. The flushed wastewater must be discharged to the septic tank or into the sand filter;

- (iv) the diameters of the distribution manifold and laterals shall not be less than ½ inch diameter and shall be constructed of schedule 40 or 80 (or equivalent) piping;
 - (v) the orifices shall not be less than 1/8-inch in diameter. All orifices shall be covered by a removable, protective, durable, non-corroding shield; and
 - (vi) other types of distribution systems may be proposed by a designer and used upon approval by the Secretary.
- (4) Sand Filter Dosing
- (A) The dose volume shall not exceed 10 percent of the daily design flow.
 - (B) The system shall not dose more than once in a 30-minute period.
 - (C) Head calculation shall include maximum static lift, pipe friction and a residual head of 5 feet at the furthest orifice.
 - (D) There shall be no more than a 10 percent flow variation between any 2 orifices.
 - (E) The pumping system shall be protected from solids by a filter apparatus that will not allow the passage of solids larger in size than 1/8 inch.
 - (F) The pump station designed to dose the sand filter shall be designed with storage equal to the 1-day design flow above the high-water alarm.
- (5) Internal Pump Option
- (A) Where the effluent from a sand filter is to be discharged by means of a pump to another treatment unit, a distribution unit, or to a leachfield, the design and construction of the sand filter may include provisions for an internal pump station, providing the following conditions are met:
 - (i) the location, design, and construction of the pump station do not conflict with the requirements of these Rules for the design, construction, and operation of a sand filter system;
 - (ii) the pump and related apparatus shall be housed in a corrosion resistant vault designed to withstand the stresses placed upon it so that it will not allow the migration of drain media, sand, or underdrain media to its interior. The vault shall:
 - (I) have a durable, attached floor; and
 - (II) provide watertight access to finished grade with a diameter large enough to remove, replace, or service any equipment in the vault and be designed to receive treated effluent from an elevation equal to that of a gravity discharging sand filter;
 - (iii) the depth of underdrain media and the operating level of the pump cycle and alarm shall not allow effluent to come within 2 inches of the bottom of the sand filter media. The pump off level shall not be lower than the bottom of the perforations of the underdrain piping; and
 - (iv) an internal sand filter pump shall be electronically linked to the sand filter dosing apparatus in such a manner as to prevent wastewater from entering the sand filter in the event the internal sand filter pump fails.
- (e) Additional requirements for the design and construction of recirculating sand filters.

- (1) Recirculating sand filters are not recommended for seasonal residences or projects designed for periodic use. Projects that will experience periodic shut downs should take into consideration the cooling effect on the recirculating effluent and the effect of the sand filters going anaerobic and becoming odoriferous.
- (2) Underdrain System
 - (A) The base of the sand filter container shall be level or constructed at a grade of 1 percent or less towards the underdrain piping.
 - (B) The underdrain piping shall be installed in the interior of the sand filter container at the lowest elevation. The piping shall be on a grade of 1 percent or less to the point of passage through the sand filter container.
 - (C) The underdrain piping and sand filter container bottom shall be covered with a minimum of 6 inches of clean washed ¾ inch to 1½ inch stone.
 - (D) Other types of underdrain systems may be proposed and approved after review by the Secretary.
- (3) Sand Filter Media
 - (A) A minimum of 36 inches of approved sand filter media shall be placed above the underdrain system.
 - (B) The sand filter media shall be soil material meeting the sieve requirements in Table 9-11.

**Table 9-11
Recirculating Sand Filter Media**

Sieve Number	Opening (mm)	Percent Passing, by Weight
3/8	9.500	100
4	4.750	60 - 100
8	2.380	7 - 75
16	1.190	0 - 5
30	0.590	0 - 3
50	0.297	0 - 2

- (C) The Secretary shall review and may approve other sand filter media when a designer submits technical justification for substitution.
- (D) The maximum application rate to size the recirculating sand filter shall be the lesser of:
 - (i) 5 gallons per day per square foot; and
 - (ii) the waste strength, expressed as gallons per square foot per day, using the formula:

$$AR = 5 \text{ gallons per square foot per day} \times 230 \text{ milligrams per liter} \div BOD_5$$
 where:
 - (I) AR is the application rate in gallons per day per square foot
 - (II) BOD₅ is the wastewater strength of the septic tank effluent in milligrams per liter.
- (4) Distribution System
 - (A) A pressurized distribution system shall be constructed in accordance with the following requirements:

- (i) there shall be a minimum of 3 inches of clean washed $\frac{3}{4}$ inch to $1\frac{1}{2}$ inch stone that is below the distribution laterals and above the sand filter media, and sufficient stone covering the orifice shields to provide a smooth even cover;
 - (ii) distribution laterals shall be spaced on maximum 24-inch centers. Orifices shall be placed such that there is at least 1 orifice for each 4 square feet of sand surface area;
 - (iii) the ends of the distribution laterals shall be designed and constructed with a means to perform flushing of the piping, collectively or individually, through the operation of a non-corroding and accessible valve. The flushed wastewater must be discharged to the septic tank, recirculating tank or into the sand filter;
 - (iv) the diameters of the distribution manifold and laterals shall not be less than $\frac{1}{2}$ inch diameter and shall be constructed of schedule 40 or 80 (or equivalent) piping;
 - (v) the orifices shall not be less than $\frac{1}{8}$ inch in diameter. All orifices shall be covered by a removable, protective, durable, non-corroding shield; and
 - (vi) other types of distribution systems proposed by a designer may be approved by the Secretary.
- (B) Recirculation/Dilution Tank and Dosing
- (i) The recirculation tank receives septic tank effluent and overflow from the sand filter. The recirculation tank shall have sufficient capacity to provide 1 day's emergency storage above a high-water alarm level. The recirculation tank and dosing system shall comply with the following requirements:
 - (I) The system shall be designed with a minimum recirculation ratio of not less than 4. The recirculation ratio is the daily volume of recycled effluent divided by the design flow.
 - (II) The sand filter shall be wetted 48 times per day. The minimum resting period between doses shall be 20 minutes.
 - (III) The minimum wet volume in the recirculation tank shall be at least 80 percent of the design flow.
 - (IV) The system shall be designed so that 100 percent of the sand filter effluent returns to the recirculation tank when the liquid volume of the tank is less than 80 percent of the project design flow.
 - (V) There shall be a high-water alarm, and a low water alarm designed and installed to shut down the pump and notify the owner of the system when the liquid level of the recirculation tank is less than 50 percent of the project design flow.
 - (VI) Head calculations shall include maximum static lift, pipe friction and a residual head of 5 feet at the furthest orifice.
 - (VII) There shall be no more than a 10 percent flow variation between any 2 orifices.

- (VIII) The pumping system shall be protected from solids by a filter apparatus that will not allow the passage of solids larger than 1/8 inch in diameter.

§ 1-925 Constructed Wetlands

- (a) A Class 1, Class B, or Class BW designer is required to submit the installation certification required for the installation of a wastewater system that includes a constructed wetland.
- (b) The use of constructed wetlands in the design of a wastewater system is optional and may be proposed as a treatment component of a wastewater system.
- (c) General requirements for constructed wetlands
- (1) A constructed wetland shall include a wetland container that is watertight to prevent wastewater from exfiltrating the filter container and be made of one of the following materials:
- (A) reinforced concrete;
- (B) flexible membrane liner materials, provided they comply with the following requirements:
- (i) they have properties that are at least equivalent to 30-mil unreinforced polyvinyl chloride;
- (ii) they have field repair instructions and extra liner material that are provided to the purchaser with the liner;
- (iii) they have factory fabricated “boots” suitable for field bonding onto the liner to facilitate the passage of piping through the liner in a waterproof manner; and
- (iv) they are compatible with the wastewater being treated; or
- (C) other materials having equivalent function and watertightness for the life of the wetland.
- (2) The design of a constructed wetland shall be based on an industry accepted publication that identifies construction requirements, test requirements, and wastewater strength sampling results. Publications shall include wetlands constructed and monitored for wastewater strength in a climate like Vermont.
- (3) The design of a wetland shall include plant species that are demonstrated by the applicant’s designer to treat septic tank effluent.
- (4) Constructed wetlands shall include only plant species that are native to Vermont and plants that will not adversely impact existing wetland species.
- (d) Prior to submitting an application for a wastewater system that includes a constructed wetland, the prospective applicant shall have their designer contact the Secretary to review the basic principles on which the design will be based.

Note: The effluent resulting from a constructed wetland may be filtrate effluent.

§ 1-926 Storage and Dose Approach to Wastewater Systems

- (a) A Class 1 designer is required to submit the installation certification required for the installation of a wastewater system that uses a storage and dose approach.
- (b) Notwithstanding the depths of naturally occurring soil required pursuant to § 1-903 to site a leachfield on sites where the height of the seasonal high-water table would otherwise preclude the construction of a wastewater system, wastewater systems with a design flow of 700 gallons per day or less that use a storage and dose approach can be permitted.
- (c) Minimum requirements for a wastewater system using a storage and dose approach:
 - (1) Wastewater may be stored without discharging to the leachfield for a maximum of 3 months.
 - (2) The wastewater system shall be designed so that the induced water table will remain at least 6 inches below ground surface when wastewater, including that which was stored, is discharged to the leachfield.
 - (3) The wastewater system shall be designed using the 2-year time of travel management zone specified in § 1-907.
 - (4) The wastewater system shall include storage tanks that are sized to store the average water use of the building or structure or campground to be served by the wastewater system, taking into account the expected occupancy of the building or structure or campground, for the expected duration of the storage period.
 - (A) If the wastewater system will serve a building or structure with a residential use, the storage tanks shall be sized to store, for a 30-day storage period, a minimum of 150 gallons per day per living unit plus an additional 50 gallons per day per person above three for a living unit with a proposed maximum residential occupancy over three persons.
 - (B) The wastewater system shall provide space for additional storage tanks to be added to accommodate the design flow identified in § 1-803.
 - (C) The storage tanks shall include a high-water alarm system and space for 5 days of storage shall be provided above the alarm level.
 - (5) The design of the wastewater system shall incorporate a groundwater monitoring control system that allows discharge of wastewater to the leachfield only when the induced water table remains at least 6 inches below ground surface.

§ 1-927 Simplified Method of Completing a Hydrogeological Analysis

The simplified method for calculating the minimum length of a leachfield.

- (1) The linear loading rate shall be calculated using the formula $LLR = (h) \times (f)$ where:
 - (A) LLR = linear loading rate, in gallons per day per linear foot of leachfield, measured parallel to the natural ground contours;
 - (B) h = the soil thickness available for groundwater mounding, measured in feet; and
 - (C) f = the LLR factor from Table 9-12, based on soil texture and ground slope.
 - (i) Unless Subsection (1)(C)(ii) or (iii) apply, the value of the f-factor from Table 9-12 shall be determined using the finest textured soil within the thickness available for groundwater mounding.

- (ii) When any overlying soil layer that is within the thickness available for groundwater mounding has an f-factor that is less than the f-factor of any underlying soil layer that is within the thickness available for groundwater mounding, the lowest f-factor shall be used to calculate the total LLR of all soil layers.
 - (iii) When the f-factor of each overlying soil layer that is within the thickness available for groundwater mounding is greater than the f-factor of any underlying soil layer that is within the thickness available for groundwater mounding, the LLR may be calculated for the overlying soil layer and underlying soil layer separately for each thickness and the two numbers shall be added together to obtain the allowable LLR for the wastewaters system.
- (2) The minimum leachfield length shall be calculated using the formula $SL = DF \div LLR$ where:
- (A) SL is the system length; and
 - (B) DF is the design flow.

**Table 9-12
Linear Loading Rate Factors Based on Soil Texture and Ground Slope**

Soil Texture	LINEAR LOADING RATE FACTORS (f)						
	Ground Slope						
	0 - 2%	> 2 - 4%	> 4 - 6%	> 6 - 8%	> 8 - 10%	> 10 - 15%	> 15 - 20%
Coarse Sand, Sand, Loamy Coarse Sand, Loamy Sand	7.5	22.4	37.4	52.4	52.4	52.4	52.4
Coarse Sandy Loam, Sandy Loam, Fine Sand, Very Fine Sand, Loamy Fine Sand, Loamy Very Fine Sand	3.7	11.2	18.7	26.2	33.7	33.7	33.7
Fine Sandy Loam, Very Fine Sandy Loam	1.5	4.4	7.5	10.5	13.5	18.7	26.2
Loam	1.1	3.4	5.6	7.9	10.1	14.0	19.6
Silt Loam	0.7	2.2	3.7	5.2	6.7	9.4	13.1
Sandy Clay Loam, Silty Clay Loam, Clay Loam	0.4	1.1	1.9	2.6	3.4	4.7	6.5
Sandy Clay, Silty Clay, Clay	0.2	0.7	1.1	1.6	2.0	2.8	3.9

Note: Completion of the simplified method does not preclude the design of a wastewater system from being based on the use of a different method for completing the hydrogeological analysis which may result in a lower linear loading rate.

Note: Examples for calculating the induced water table using the simplified method are included in Appendix B, Examples B-2.

§ 1-928 Holding Tanks

- (a) The Secretary shall approve the use of holding and pump out tanks as a wastewater system serving a building or structure in lieu of a soil-based wastewater system or sanitary sewer service line that conveys wastewater to a wastewater treatment facility or indirect discharge system when all of the following requirements are met:
 - (1) The building or structure:
 - (A) is existing or proposed and is publicly owned; or
 - (B) is existing or proposed and owned by a charitable, religious, or nonprofit organization.
 - (2) The plan for construction and operation of the holding and pump out tank shall not result in a public health hazard or environmental damage.
 - (3) A designer demonstrates that an economically feasible means of meeting current standards is significantly costlier than wastewater holding and pump out tanks, based on a projected 20-year life of the project.
 - (4) The design flows do not exceed 600 gallons per day or the existing or proposed building or structure shall not be used to host events on more than 28 days in any calendar year.
- (b) ~~The~~ Secretary may approve the use of holding and pump out tanks as a wastewater system serving a building or structure or campground in lieu of a soil-based wastewater system or sanitary sewer service line that conveys wastewater to a wastewater treatment facility or indirect discharge system when all of the wastewater to be treated does not, and is unlikely in the future to, contain pathogens. In reaching this determination the Secretary shall consider:
 - (1) the nature of the wastewater;
 - (2) the ultimate point of disposal of the wastewater; and
 - (3) the risks associated with the failure of the system to operate, or to be operated, as permitted.
- (c) The Secretary may approve a holding and pump out tank as a wastewater system serving a building or structure in lieu of a soil-based wastewater system or sanitary sewer service line that conveys wastewater to a wastewater treatment facility or indirect discharge system, whether or not the building or structure is publicly owned, when:
 - (1) the building or structure is served by an existing wastewater system that has failed, or is expected to fail;
 - (2) there is no other cost feasible alternative; and
 - (3) a variance is sought and granted pursuant to § 1-802 from all technical standards in this Subchapter and Subchapter 10 that would otherwise apply.
- (d) The Secretary shall approve the use of a marine holding and pump out tank as a wastewater system, where it is not feasible to discharge the contents of marine wastewater holding and pump out tanks to a soil-based wastewater system or to a sanitary sewer service line that conveys wastewater to a wastewater treatment facility or indirect discharge system.

- (e) A holding and pump out tank shall:
 - (1) be capable of holding at least 14 days of the expected flow from the building or structure or campground;
 - (2) be constructed of durable materials that are appropriate for the site conditions and the nature of the wastewater to be stored;
 - (3) be watertight, and any piping connected to the tank, and all access structures connected to the tank shall be watertight;
 - (4) prior to being placed in service, be tested for watertightness using the same method as identified in § 1-1010;
 - (5) be designed to protect against floatation when the tank is empty, such as when it is pumped;
 - (6) be equipped with audio and visual alarms that are triggered when the tank is filled to 75 percent of its design capacity; and
 - (7) be located so that it can be reached by tank pumping vehicles at all times when the building or structure or campground is occupied.

- (f) Any building or structure or campground served by a holding and pump out tank, other than a marine holding and pump out tank, shall have a water meter, or meters, installed that measures all water that will be discharged as wastewater from the building or structure or campground.

- (g) A permit issued for the use of a holding and pump out tank shall require a designer to periodically inspect the tank, visible piping, and alarms and meet the following requirements:
 - (1) A designer shall submit a written report to the Secretary detailing the results of the inspection and any repairs or changes in operation that are required.
 - (2) The report shall also detail the pumping history since the previous report, giving the dates of pumping and the volume of wastewater removed.
 - (3) The frequency of inspections and reports shall be stated in the permit issued for the use of the tank, but shall be no less frequent than once per year.
 - (4) Unless permitting a marine holding and pump out tank, the designer shall also inspect the water meter or meters and verify that they are installed, calibrated, and measuring all water that is discharged as wastewater.
 - (5) Unless permitting a marine holding and pump out tank, the designer shall read the meters and compare the metered flow to the pumping records.
 - (6) Any significant deviation shall be noted in the report and explained to the extent possible.

- (h) A permit authorizing a holding and pump out tank as a wastewater system pursuant to Section (a) shall not run with the land, unless it is issued to a charitable, religious, or non-profit organization.
 - (1) When a permit is issued to a charitable, religious, or non-profit organization it shall apply to all subsequent owners of the property being served by the holding tank for the duration of the permit regardless of whether the owner is a charitable, religious, or non-profit organization.
 - (A) A subsequent owner shall not increase the design flow of the holding and pump out tank system, or, take any other action which requires the

issuance of a permit or permit amendment without seeking a permit or permit amendment.

(B) All permit conditions, including the financial surety requirement of Subsection (a)(5), shall apply to a subsequent owner.

- (i) A permit authorizing a holding and pump out tank as a wastewater system under a provision of this Section shall require the owner of a holding and pump out tank to maintain a valid contract with a licensed wastewater hauler at all times.
 - (1) The contract shall require the licensed wastewater hauler to provide written notice of dates of pumping and volume of wastewater pumped.
 - (2) Copies of all such notices shall be submitted with the written inspection reports.

§ 1-929 Disposal of Contents of Composting or Incinerating Toilets

- (a) The contents of a composting or incinerating toilet, provided the toilet does not yield a liquid, may be disposed of as directed in Subsection (c).
- (b) The installation and use of composting or incinerating toilets does not create an exemption from any requirement of these Rules, including the requirement that all buildings or structures have wastewater systems that comply with the technical standards in this Subchapter and Subchapters 8 and 10, for the disposal of all other wastewater from the building or structure.
- (c) The contents removed from a composting or incinerating toilet shall be disposed of in the following manner:
 - (1) If disposed of on the same lot on which the toilet is located, the contents shall be disposed of by shallow burial at a location approved by the Secretary in a permit, provided the location meets the following requirements:
 - (A) complies with the isolation distances and isolation zones required pursuant to § 1-912 for locating an in-ground leachfield; and
 - (B) maintains a 3-foot separation between the bottom of the excavation for the contents to the seasonal high-water table and a 4-foot separation between the bottom of excavation for the contents to bedrock.
 - (2) If not disposed of on the same lot on which the toilet is located, the contents shall be disposed of:
 - (A) at a certified landfill; or
 - (B) in accordance with the Vermont Solid Waste Management Rules.

§ 1-930 Discontinuing Use and Removal of a Wastewater System

- (a) A wastewater system that is no longer serving a building or structure or campground, may remain in place, provided all tanks, including the septic tanks, pump stations, and dosing siphons, are:
 - (1) pumped; and
 - (2) broken in-place or filled with soil.
- (b) When a leachfield is removed, the stone, fill material, and soil removed from in and around the components, shall be disposed of in the following manner:

- (1) If disposed of on the same lot on which the wastewater system is located, the material shall be disposed of in a location approved by the Secretary in a permit, provided the location meets the following requirements:
 - (A) complies with the isolation distances and isolation zones required pursuant to § 1-912 for locating an in-ground leachfield; and
 - (B) maintains a 3-foot separation between the bottom of the burial to the seasonal high-water table and 4-foot separation between the bottom of the burial to bedrock.
- (2) If not disposed of on the same lot on which the wastewater system is located, the material shall be disposed of:
 - (A) at a certified landfill; or
 - (B) in accordance with the Vermont Solid Waste Management Rules.

Subchapter 10 – Flexible Specific Technical Standards for Wastewater Systems

§ 1-1001 Request for Alternative Technical Standard

- (a) The Secretary may accept, in an application for a permit or permit amendment, the use of an alternative technical standard to a technical standard included in this Subchapter when the Secretary concludes that the alternative technical standard:
 - (1) will meet the purpose served by the technical standard in this Subchapter;
 - (2) has been adopted and published by one of the following organizations:
 - (A) American Association of the State Highway and Transportation Officials (AASHTO);
 - (B) National Science Foundation (NSF);
 - (C) American National Standards Institute, Inc. (ANSI);
 - (D) American Society of Civil Engineers (ASCE);
 - (E) American Public Works Association (APWA);
 - (F) American Society for Testing and Materials (ASTM);
 - (G) American Water Works Association (AWWA);
 - (H) Cast Iron Soil Pipe Institute (CISPI);
 - (I) Ductile Iron Pipe Research Association;
 - (J) New England Interstate Water Pollution Control Commission (NEIWPCC); and
 - (K) 10 States Standards – Recommended Standards for Wastewater Facilities;
 - (3) incorporates more current technology than included in the technical standard in this Subchapter; and
 - (4) will not adversely affect the maintainability, operation, or safety of the wastewater system; and
 - (5) where specified, meets any additional criteria required by these Rules for a Secretary approved alternative technical standard.

- (b) An application that seeks to use an alternative technical standard shall include a written request that includes:
 - (1) the specific technical standard in this Subchapter for which approval of an alternative technical standard is sought; and
 - (2) supporting documentation demonstrating each of the findings included in Subsection (a).

§ 1-1002 General Requirements for Sanitary Sewer Service Lines

- (a) Groundwater or stormwater drains including roof drains, area drains, foundation drains, and cellar drains shall not connect to sanitary sewer service lines.

- (b) Sanitary sewer service lines shall be sized for the design flow and, for gravity sewers, shall be a minimum of 4 inches in diameter.

- (c) Sanitary sewer service lines shall comply with the following requirements.
 - (1) Pipes from a building or structure to a septic tank, from a septic tank to a distribution box or leachfield, and from a septic tank to a pump or siphon chamber:

- (A) shall be non-perforated rigid pipe; and
 - (B) shall have all pipe penetrations to tanks, chambers, or boxes sealed to prevent leakage.
- (d) Sanitary sewer service lines shall be constructed of one of the following materials:
- (1) rubber ring jointed or solvent welded polyvinyl chloride SDR 35 with oil-resistant gasket joints complying with standard ASTM D-1869;
 - (2) cast iron (CI) or other sewer pipe that complies with the Vermont Plumbing Rules or ASTM standards;
 - (3) Ductile iron gravity sewer pipe, ASTM A746; or
 - (4) extra heavy cast iron where sanitary sewer service lines are designed or anticipated to be installed at a depth of less than 3 feet under driveways.
- (e) Sanitary sewer service lines carrying raw or untreated wastewater shall maintain a minimum slope of 1/4 inch per foot.
- (f) Sanitary sewer service lines carrying septic tank effluent shall maintain a minimum slope of 1/8 inch per foot.
- (g) Sanitary sewer service lines shall:
- (1) be buried sufficiently deep to prevent freezing; and
 - (2) have a minimum bury depth of:
 - (A) 4 feet;
 - (B) in areas subject to plowing or snow removal, 5 feet; or
 - (C) a number approved by the Secretary when a designer demonstrates that a shallower bury depth will protect the sanitary sewer service line from frost and other superimposed loads.
- (h) Connection of a sanitary sewer service line to a sanitary sewer collection line shall be:
- (1) through a manhole; or
 - (2) with a wye fitting so as to direct flow and minimize in line turbulence.
- (i) Cleanouts or manholes shall be provided on a sanitary sewer service line carrying raw or untreated wastewater at:
- (1) each horizontal change in direction greater than 45 degrees and at intervals of not more than 100 feet; or
 - (2) at intervals of 40 feet of length where more than one change of direction of less than 45 degrees occurs in a run of piping.
- (j) Sanitary sewer service lines with changes in direction that exceed 45 degrees shall be made with two 45-degree ells or long sweep fittings or made with a manhole.
- (k) A sanitary sewer collection line that conveys wastewater from two or more buildings or structures may be considered a sanitary sewer service line under these Rules and comply with the requirements for a sanitary sewer service line in lieu of the requirements for a sanitary sewer collection line when:
- (1) the total length of the sanitary sewer collection line and each sanitary sewer service line is less than 300 feet;

- (2) cleanouts, not manholes, are provided where the sanitary sewer service lines join; and
 - (3) the distance between cleanouts does not exceed 100 feet.
- (l) When a design for a sanitary sewer service line or sanitary sewer collection line contains a septic tank or a grease tank, the design of the septic tank or the grease tank shall comply with the requirements in § 1-908 and § 1-909(c) and (d).

§ 1-1003 General Requirements for Sanitary Sewer Collection Lines

- (a) Groundwater or stormwater drains, including roof drains, area drains, foundation drains, and cellar drains, shall not connect to sanitary sewer collection lines.
- (b) Sanitary sewer collection lines shall be sized for the design flow even when the diameter of the receiving collection line is less than the diameter of the proposed line. The Agency may require a schedule for future downstream sewer relief.
- (c) Sanitary sewer collection lines carrying raw or untreated wastewater shall:
 - (1) be a minimum of 6 inches in diameter for gravity sewers;
 - (2) be sized to transport the peak hourly flow rate, calculated using the design flows listed in § 1-803 for buildings or structures or campgrounds multiplied by the peaking factors listed in Table 10-1, in order to provide:
 - (A) a minimum velocity of 2.0 feet per second when flowing full using the Manning equation and roughness coefficients appropriate for the pipe materials proposed considering surface deterioration over the expected useful life of the pipe; or
 - (B) have the pipe diameter and slope selected to obtain the greatest practical velocities to minimize settling problems when maintaining 2.0 feet per second is not attainable. Oversize sewers will not be approved to justify using flatter slopes. If the proposed slope is less than the minimum slope of the smallest pipe which can accommodate the peak hourly flow rate, the designer shall provide calculations to justify solids deposition will not be an issue using the smallest pipe; and
 - (3) where velocities greater than 15 feet per second are attained, have special provisions made to protect against displacement by erosion and shock.

**Table 10-1
Peaking Factors**

Design Flow in gallons per day	Peaking Factor
less than 10,000	5.0
10,000 to less than 100,000	4.2
100,000 to less than 500,000	3.8
500,000 to less than 1,000,000	3.2
1,000,000 or greater	3.0

- (d) Sanitary sewer collection lines shall be designed:

- (1) with the minimum slopes shown in Table 10-2 regardless of the formula used or friction factors used in the design of the lines; and
- (2) when a smaller sanitary sewer collection line joins a larger sanitary sewer collection line, the bottom of the larger sanitary sewer collection line shall be lowered sufficiently to maintain the same energy gradient. A method for securing these results is to place the 0.8 depth point of both sewers at the same elevation.

**Table 10-2
Minimum Slopes**

Size (inches Pipe)	Slope (feet/100 feet)
6	0.60
8	0.40
10	0.28
12	0.22
15	0.15
18	0.12

- (e) Sanitary sewer collection lines shall:
 - (1) be sufficiently deep to prevent freezing; and
 - (2) have a bury depth:
 - (A) of at least 4 feet; or
 - (B) at least 5 feet in areas subject to plowing or snow removal that allows for deeper frost penetration, unless Subsection (f) applies.

- (f) When the depths in Subsection (e)(2)(B) cannot be maintained without significant expense and when the design demonstrates the collection line will be protected from frost or other superimposed loads, the Secretary may approve a sanitary sewer collection line placed at shallower depths.

- (g) Sanitary sewer collection lines shall be laid with uniform slope and straight alignment between manholes.

- (h) Sanitary sewer collection lines on 20 percent slopes or greater shall be anchored securely with concrete anchors or equal spaced as follows:
 - (1) not over 36 feet center to center on grades 20 percent and less than 35 percent;
 - (2) not over 24 feet center to center on grades 35 percent and less than 50 percent; and
 - (3) not over 16 feet center to center on grades 50 percent and over.

- (i) Sanitary sewer collection lines and fittings shall be constructed of one of the following materials:
 - (1) rubber ring jointed polyvinyl chloride pipe, meeting the requirements of ASTM 3034 for SDR 35 or heavier;
 - (2) fused HDPE;
 - (3) ductile iron (DI) gravity sewer pipe of the proper class; or
 - (4) other materials approved by the Secretary.

- (A) In determining if the pipe material is appropriate for the specific use, the Secretary shall consider:
 - (i) the character of the waste (domestic, commercial or industrial);
 - (ii) soil characteristics;
 - (iii) exceptionally heavy external loadings;
 - (iv) abrasion; and
 - (v) corrosion.
 - (B) The Secretary may require the designer to submit information from the pipe manufacturer certifying that the materials are acceptable for the specific use.
- (j) Sanitary sewer collection line joints shall:
- (1) have couplings complying with ASTM specifications, including oil resistant joints that comply with ASTM D-1869;
 - (2) be designed to minimize infiltration and to prevent the entrance of roots throughout the life of the system; and
 - (3) be of similar materials as the collection line.
- (k) Sanitary sewer collection lines shall be designed to prevent damage from superimposed, live, dead, and frost induced loads.
- (1) Proper allowance loads on the sewer shall be made based on the soil characteristics and potential groundwater conditions as well as the width and depth of trench.
 - (2) Where necessary, special bedding, haunching and initial backfill, concrete cradle, or special construction shall be used to withstand the anticipated potential superimposed loading or loss of trench wall stability.
- (l) Sanitary sewer collection line trenching shall comply with the following requirements:
- (1) Ledge, rock, boulders, and large stones shall be removed to provide a minimum clearance of four inches below and on each side of all pipes.
 - (2) All water entering the excavations or other parts of the work shall be removed until all the work is complete.
- (m) Sanitary sewer collection line bedding shall comply with the following requirements:
- (1) Bedding Class A, B, C, or crushed stone as described in ASTM C 12 or bedding that complies with the Vermont Agency of Transportation's 2011 Standard Specifications for Construction shall be used and carefully compacted for all rigid pipe provided the proper strength pipe is used with the specified bedding to support the anticipated load based on the soil type encountered and potential water table.
 - (2) Embedment materials for bedding, haunching and initial backfill shall be Classes I, II, or III as described in ASTM D 2321 and shall be carefully compacted for all flexible pipe provided the proper strength pipe is used with the specified bedding to support the anticipated load based on the soil type encountered and potential water table.
 - (3) Backfill shall be of a suitable material removed from the excavation except where other material is specified. Debris, frozen material, large clods or stones, organic

matter, or other unstable materials shall not be used for backfill within 2 feet of the top of the pipe.

- (4) Final backfill shall be placed in such a manner as not to disturb the alignment of the pipe.

- (n) Trenchless technologies that may be used in lieu of open-trenching include:
 - (1) jack and bore and pipe jacking;
 - (2) micro-tunneling; and
 - (3) horizontal directional drilling.

- (o) Upon completion of construction of a sanitary sewer collection line and prior to backfilling over the collection line, leakage testing shall be performed in accordance with one of the following procedures:
 - (1) Water (Hydrostatic) Leakage Testing
 - (A) Plug or cap all service laterals, stubs, and fittings. Place adequate bracing to withstand thrust forces.
 - (B) A tapped plumber's plug shall be inserted in the downstream manhole inlet sewer. The water supply connection is made at this point, but never directly from a water main, including the fire hydrant, unless a backflow preventer is used.
 - (C) A stand pipe is tightly connected at the upstream end of the sanitary sewer service line or sanitary sewer collection line. The height of the stand pipe shall be at least 2 feet higher than any point in the line or 2 feet higher than the highest known water table, whichever is higher. A manhole may be used as a stand pipe.
 - (D) Water is added at the downstream connection in order to avoid trapping air bubbles or pockets. The line shall be filled to the elevation designated in the stand pipe.
 - (E) Allow the line to stand with water for at least a 2-hour stabilization period or such shorter period as may be required to achieve stabilized readings of water loss over three consecutive 15-minute periods. This allows air to escape and absorption to take place.
 - (F) Fill the sanitary sewer service line or sanitary sewer collection line to the reference mark and continue the test for at least 1 hour. Maintain the minimum head throughout the test, adding any volume of water required and including that volume in the leakage.
 - (G) Convert the calculated leakage to gallons per inch of pipe diameter per mile per day.
 - (H) Gravity sanitary sewer collection lines including manholes shall not exceed leakage of 200 gallons per inch of pipe diameter per mile per day.
 - (2) Air Testing
 - (A) Procedures
 - (i) Determine the test time for the section of line to be tested using Table 10-3 or Table 10-4 or the formulas in Chart 10-1.
 - (ii) Plug all openings in the test section.
 - (iii) Add air until the internal pressure of the line is raised to approximately 4.0 pounds per square inch (psi) greater than the average pressure of any groundwater. After this pressure is

reached, allow the pressure to stabilize. The pressure will normally drop as the air temperature stabilizes. This usually takes 2 to 5 minutes depending on the pipe size. The pressure may be reduced to 3.5 psi before starting the test.

- (iv) When the pressure has stabilized and is at or above the starting test pressure of 3.5 psi above the pipe start the test. If the pressure drops more than 1.0 psi during the test time, the line is presumed to have failed the test. If a 1.0 psi drop does not occur within the test time, the line has passed the test.

(B) Test Time

- (i) Table 10-3 shows the required test time, T, in minutes per 100 feet of pipe for each nominal pipe size. Test times are for a 1.0 psi pressure drop from 3.5 to 2.5 psi. Table 10-3 has been established using the formulas contained in Chart 10-1.
- (ii) If the section of line to be tested includes more than 1 pipe size, calculate the test time for each size and add the test times to arrive at the total test time for the section.
- (iii) It is not necessary to hold the test for the whole period when it is clearly evident that the rate of air loss is less than the allowable.

**Table 10-3
Minimum Test Time for Various Pipe Sizes**

Nominal Pipe Size in inches	T (time) minutes per 100 feet	Nominal Pipe Size in inches	T (time) minutes per 100 feet
3	0.2	21	3.0
4	0.3	24	3.6
6	0.7	27	4.2
8	1.2	30	4.8
10	1.5	33	5.4
12	1.8	36	6.0
15	2.1	39	6.6
18	2.4	42	7.3

**Chart 10-1
Formulas and Allowable Air Loss Standards**

Calculate the required test time at a given allowable air loss as follows:

$$T = (K)[(D^2)(L) \div (Q)]$$

Calculate air loss with a timed pressure drop as follows:

$$Q = (K)[(D^2)(L) \div T]$$

Where:

D = nominal size in inches;

L = length of line of 1 pipe size in feet;

$K = 0.534 \times 10^6$ for S.I. units (International Standard of Units) or
 0.371×10^3 for inch pound units;
 Q = air loss in cubic feet per minute; and
 T = time for pressure to drop 1.0 pound per square inch in minutes

- (C) An appropriate allowable air loss, Q , in cubic feet per minute, has been established for each nominal pipe size. Based on field experience, the Q value that has been selected will enable detection of any significant leak. Table 10-4 lists the Q established for each pipe size.

Table 10-4
Allowable Air Loss for Various Pipe Sizes

Nominal Pipe Size in Inches	Q ft ³ /min	Nominal Pipe Size in Inches	Q ft ³ /min
3	2.0	21	5.5
4	2.0	24	6.0
6	2.0	27	6.5
8	2.0	30	7.0
10	2.5	33	7.5
12	3.0	36	8.0
15	4.0	39	8.5
18	5.0	42	9.0

- (D) The air test shall, at a minimum, conform to the test procedure described in ASTM C 828-86 for clay pipe, ASTM C 924 for concrete pipe, and ASTM F 1417 for plastic pipe.
- (3) A designer may present other methods for conducting leakage testing to the Secretary for approval prior to conducting the test.
- (p) Thirty or more days following final backfill of the sanitary sewer collection line, the following tests shall be performed:
- (1) Deflection tests shall be performed on all flexible sanitary sewer collection lines to verify the following requirements are met:
- (A) No pipe shall exceed a deflection of 5 percent. If deflection exceeds 5 percent, the pipe shall be excavated. Replacement or correction shall be accomplished in accordance with requirements in the approved specifications.
- (B) The rigid ball or mandrel used for the deflection test shall have a diameter not less than 95 percent of the base inside diameter or average inside diameter of the pipe depending on which diameter is specified in the ASTM Specification, including the appendix, to which the pipe is manufactured. The test shall be performed without mechanical pulling devices.
- (2) The sanitary sewer collection line shall be tested for alignment to verify the following requirements are met:

- (A) Each segment of pipe between manholes shall pass a lamp test for correctness of horizontal and vertical alignment.
- (B) Water shall be introduced into each pipe segment with no standing water observed during the test.
- (C) If the collection line fails the alignment test, the pipe shall be excavated. Replacement or correction shall be accomplished in accordance with requirements in the approved specifications.

§ 1-1004 Requirements for Sanitary Sewer Manholes

- (a) Required locations for manholes in sanitary sewer collection lines
 - (1) Manholes shall be installed:
 - (A) at the end of each sanitary sewer collection line;
 - (B) at all changes in grade, size or alignment;
 - (C) at all intersections; and
 - (D) at distances not greater than 400 feet except manholes may be spaced at distances of 600 feet:
 - (i) for municipal sanitary sewer collection lines, when the municipality has the equipment capable of cleaning the sewer for 600 feet and submits a letter to the Secretary verifying ownership of the equipment: or
 - (ii) for a privately owned sanitary sewer collection line, if a municipality submits a letter to the Secretary indicating its intent to take over ownership or control of the line upon completion of construction and verifying that it has the equipment capable of cleaning the sewer for 600 feet.
 - (2) Notwithstanding Subsection (a)(1), when the sanitary sewer service line or sanitary sewer collection line is carrying only effluent, the Secretary may approve greater distances between manholes than that specified in Subsection (a)(1). In determining whether to authorize greater distances the Secretary shall consider the following factors:
 - (A) the diameter of the sanitary sewer collection line; and
 - (B) availability of cleaning equipment.
- (b) Required diameter of manholes:
 - (1) The minimum diameter of manholes shall be 48 inches; large diameters are preferred for connection to large diameter sewers.
 - (2) A minimum access diameter of 24 inches shall be provided.
 - (3) Larger access diameters may be required by VOSHA to meet confined space entry procedures.
- (c) Requirements for drop manholes:
 - (1) A drop pipe shall be provided for a sewer entering a manhole at an elevation of 24 inches or more above the manhole bottom.
 - (2) Where the difference in elevation between the incoming sanitary sewer collection line or sanitary sewer service line and the manhole bottom is less than 24 inches, the bottom shall be filleted to prevent deposition of solids.

- (3) Outside drop connections, due to the unequal earth pressures that would result from the backfilling operation in the vicinity of the manhole, shall have the entire outside drop connection encased in concrete.
 - (4) Inside drop connections, when necessary, shall be secured to the interior wall of the manhole. Where inside drops are used, the manhole diameter shall be increased to 60 inches to allow adequate access for cleaning and maintenance except when a municipality requests an inside drop to an existing manhole that has a minimum diameter of 4 feet.
- (d) Flow channels shall be provided in the base of all manholes. The flow channel through manholes shall:
- (1) conform in shape and slope to that of the sanitary sewer collection line or sanitary sewer service line entering and exiting the manhole;
 - (2) be constructed so that the flow at peak conditions will remain in the flow channel; and
 - (3) for curved flow channels, slope through the manhole shall be increased to maintain the necessary velocities.
- (e) Manholes shall include a bench that meets the following requirements:
- (1) A bench shall be provided on each side of a manhole flow channel.
 - (2) The bench shall have a slope of:
 - (A) no less than 0.5 inch per foot; and
 - (B) no greater than 1.0 inch per foot.
 - (3) No sewer shall discharge onto the surface of the bench.
- (f) Manholes shall be constructed using the following material:
- (1) Manholes shall be of the precast concrete or poured in place concrete type.
 - (2) Manholes shall be waterproofed on the exterior.
 - (3) Inlet and outlet pipes shall be joined to the manhole with a flexible watertight gasket that allows differential settlement of the pipe and manhole wall to take place.
 - (4) A watertight connection using non-shrink mortar that allows differential settlement of the pipe and manhole wall to take place is acceptable when connecting a new sanitary sewer service line or sanitary sewer collection line to an existing manhole when it is impractical to make the connection using a gasketed flexible watertight connection.
 - (5) Watertight manhole covers shall be used wherever the manhole tops may be flooded by street runoff or high-water.
 - (6) After the manhole has been assembled in place, all lifting holes, whether or not the holes penetrate through the manhole, depressions and exterior joints shall be filled and pointed with non-shrinking mortar or other comparable material.
- (g) Where groundwater may affect the buoyancy of a manhole, appropriate construction specifications to prevent movement of the manhole shall be provided.
- (h) Upon completion of construction of a manhole, leakage testing of manholes shall be performed in accordance with one of the following procedures:
- (1) Water (Hydrostatic) Leakage Testing

- (A) All pipes and other openings into the manhole shall be suitably plugged to prevent blowout.
 - (B) Each manhole shall be checked for exfiltration by filling with water to the top of the cone section.
 - (i) A stabilization period of 1 hour shall be provided to allow for absorption.
 - (ii) At the end of this period, the manhole shall be refilled to the top of the cone, if necessary, and the measuring time of at least 6 hours begins.
 - (iii) At the end of the test period, the manhole shall be refilled to the top of the cone measuring the volume of water added.
 - (C) The volume of water in (B) needed to refill the manhole shall be converted to a 24-hour rate and the leakage determined on the basis of depth.
 - (D) The leakage for each manhole shall not exceed 1 gallon per vertical foot for a 24-hour period for exfiltration and there shall be no visible infiltration.
 - (E) If more than 1 gallon per vertical foot for a 24-hour period for exfiltration occurs or there is visible infiltration within the test period, the manhole failed the test and shall be repaired or reconstructed and retested.
- (2) Vacuum Leakage Testing
- (A) Manholes that have been backfilled shall be excavated to expose the entire exterior prior to vacuum testing.
 - (B) All pipes and other openings in the manhole shall be plugged in a manner to prevent displacement.
 - (C) A plate with an inflatable rubber ring the size of the top of the manhole shall be installed by inflating the ring with air to a pressure adequate to prevent leakage of air between the rubber ring and the manhole wall.
 - (D) Air shall then be pumped out of the manhole through an opening in the plate until a vacuum is created inside of the manhole equal to 10 inches of mercury on an approved vacuum gauge. The removal of the air shall then be stopped and the test time begun. The vacuum drop shall not exceed 1 inch of mercury over the period of time as follows:
 - (i) 0 to 10-foot deep manholes – 2 minutes;
 - (ii) greater than 10 feet to 15-foot deep manholes – 2.5 minutes; or
 - (iii) greater than 15-foot deep manholes – 3 minutes.
 - (E) If more than 1 inch of drop in vacuum occurs within the test period, the manhole failed the test and shall be repaired or reconstructed and retested.
 - (F) Air testing of concrete sewer manholes may conform to the test procedures described in ASTM C 1244.
- (3) Following satisfactory test results, the manhole may be backfilled.

§ 1-1005 Requirements for Inverted Siphons

Inverted siphons shall:

- (1) Have not less than 2 barrels with a minimum pipe size of 6 inches.
- (2) Have inlet and discharge structures
 - (A) with adequate clearances for cleaning equipment, inspection, and flushing (vented manholes are recommended); and

- (B) that are arranged so that the design flow is diverted to 1 barrel and so that either barrel may be cut out of service for cleaning.
- (3) Provide sufficient head and appropriate pipe sizes to secure re-suspension velocities of at least 3.0 feet per second for design average flows to prevent settling in pipes.
- (4) Have a vertical alignment that allows cleaning and maintenance.

§ 1-1006 Design Standards for Sanitary Sewer Collection Lines and Sanitary Sewer Service Lines Under and Over Surface Waters

- (a) Sanitary sewer collection lines and sanitary sewer service lines shall:
 - (1) be designed to avoid stream crossings when possible;
 - (2) minimize the number of stream crossings when stream crossings are needed; and
 - (3) when crossing a stream, be designed to cross under the stream as nearly perpendicular to the stream flow as possible.
- (b) The horizontal location of sanitary sewer collection lines and sanitary sewer service lines along streams shall be sufficiently far from the stream to:
 - (1) allow for meander belt of the stream as required by the Watershed Management Division;
 - (2) allow for possible future widening of the stream due to bank erosion;
 - (3) prevent discharges into the stream of dirt, silt or other substances during construction; and
 - (4) allow future access for repair and maintenance of the line without entering the stream.
- (c) Sanitary sewer collection lines and sanitary sewer service lines crossing under streams shall meet the following requirements:
 - (1) Sanitary sewer collection lines and sanitary sewer service lines shall be at a sufficient depth below the natural bottom of the stream bed to protect the lines.
 - (2) When the line is located in bedrock beneath a stream, a minimum of 1 foot of cover is required.
 - (3) When the line is not located in bedrock beneath a stream a minimum of 3 feet of cover is required.
 - (4) When the line is under a paved stream channel, the top of the line shall be placed below the bottom of the channel pavement.
- (d) Construction materials for sanitary sewer collection lines and sanitary sewer service lines crossing under streams shall be:
 - (1) ductile iron pipe with restrained joints constructed so the line will remain watertight and free from changes in alignment or grade; and
 - (2) stone, coarse aggregate, washed gravel, or other materials for the backfill of the sewer trench that will not readily erode, cause discharges of dirt, silt or other materials, damage pipe during placement, or corrode the line.
- (e) Manholes for sanitary sewer service lines or sanitary sewer collection lines crossing under or over streams shall:
 - (1) not be located within the stream channel; and

- (2) be located so they do not interfere with the free discharge of flood flows of the stream.
- (f) Sanitary sewer service lines or sanitary sewer collection lines crossing aerially over streams shall meet the following requirements.
- (1) Ductile iron pipe with restrained mechanical joints is required for all aerial sanitary sewer collection line crossings.
 - (2) Support shall be provided for all joints in pipes utilized for aerial crossings. The supports shall be designed to prevent thermal expansion, vibration, frost heave, overturning, settlement or loads that may adversely affect the structural integrity of the support.
 - (3) Precautions against freezing, such as insulation and increased slope, shall be included with the design of an aerial crossing.
 - (4) Expansion jointing shall be used between above ground and below ground sanitary sewer collection lines.
 - (5) The impact of flood waters and debris shall be considered.
 - (A) When the line is not attached to a road, highway, or railroad bridge, the bottom of the pipe shall be placed no lower than the elevation of the 100-year flood.
 - (B) When the line is attached to a road, highway, or railroad bridge:
 - (i) the bottom of the pipe shall be placed above the required bottom elevation of the bridge; and
 - (ii) the pipe shall be attached to a support beam that is the least exposed to the flow of the flood waters.

§ 1-1007 Separation of Sanitary Sewer Service Lines and Sanitary Sewer Collection Lines from Water Mains, Water Service Lines and Water Service Pipes

- (a) Horizontal Isolation Distances from Water Mains, Water Service Lines, and Water Service Pipes
- (1) All portions of a sanitary sewer collection line and sanitary sewer service line shall be at least 10 feet horizontally from all portions of a proposed, existing, or permitted water mains, except where site conditions prevent obtaining the 10-foot separation and one of the following requirements is met:
 - (A) The sanitary sewer collection line or sanitary sewer service line shall be water main pipe or equivalent and, to ensure water tightness:
 - (i) shall be pressure tested at 50 pounds per square inch; or
 - (ii) all joints not meeting the 10 feet horizontal separation shall be further improved to prevent leakage using mechanically jointed non-flexible pipe couplings, concrete encasement, or other equivalent methods as approved by the Secretary.
 - (B) The bottom of the water main shall be at least 18 inches above the top of the sanitary sewer collection line or sanitary sewer service line and the water main is in a separate trench or on an undisturbed soil shelf in the sewer trench.
 - (2) All portions of a sanitary sewer collection line and sanitary sewer service line shall be at least 10 feet horizontally from all portions of a proposed, existing, or

permitted water service line or water service pipe, except when one of the following requirements is met:

- (A) The water service line or water service pipe shall be sleeved with pipe materials approved by the Vermont Plumbing Rules, and:
 - (i) if the sleeves terminate below ground, the ends of the sleeve are sealed to be watertight; or
 - (ii) if the sleeves terminate above finished slab or in a basement, the ends of the sleeve are sealed to be watertight or left open.
- (B) The water service line or water service pipe shall be in a separate trench or an undisturbed soil shelf in the sewer trench and one of the following requirements is met:
 - (i) the bottom of the water service line or water service pipe shall be at least 18 inches above the top of the sanitary sewer collection line or sanitary sewer service line; or
 - (ii) the sanitary sewer collection line or sanitary sewer service line shall be water main pipe or equivalent and, to ensure water tightness:
 - (I) shall be pressure tested at 50 pounds per square inch; or
 - (II) all joints not meeting the 10 feet horizontal separation are to be further improved to prevent leakage using mechanically jointed non-flexible pipe couplings, concrete encasement, or other equivalent methods as approved by the Secretary.

(b) Vertical Separation and Crossings for Water Mains, Water Service Lines, and Water Service Pipes

- (1) Sanitary sewer collection lines and sanitary sewer service lines crossing above proposed, existing, or permitted water mains shall be laid so the bottom of the collection line or service line is 18 inches above the top of the water main with the joints of the collection line or service line equal distance from the crossing, except where site conditions prevent obtaining the 18-inch separation and one of the following requirements is met:
 - (A) The sanitary sewer collection line or sanitary sewer service line shall be sleeved to a point 10 horizontal feet from the center line of the crossing.
 - (B) The sanitary sewer collection lines and sanitary sewer service lines shall:
 - (i) be water main pipe or equivalent and, to ensure water tightness:
 - (I) shall be pressure tested at 50 pounds per square inch; or
 - (II) all joints not meeting the 10 feet horizontal separation are to be further improved to prevent leakage using mechanically jointed non-flexible pipe couplings, concrete encasement, or other equivalent methods as approved by the Secretary; and
 - (ii) the sanitary sewer collection line shall be provided structural support, such as sleeving of the sanitary sewer, that will extend beyond the trench excavation for the water service line or water service pipe.

- (C) The sanitary sewer collection line is water main pipe or equivalent with the pipe centered over the water main and the joints of the pipe are 10 feet from the crossing.
- (2) Sanitary sewer collection lines and sanitary sewer service lines crossing below proposed, existing, or permitted water mains shall be laid so the top of the collection line or service line is 18 inches below the bottom of the water main, except when one of the following requirements are met:
 - (A) The sanitary sewer collection lines and sanitary sewer service lines shall be water works grade 150 pounds per square inch pressure rated pipe meeting water main pipe or equivalent and, to ensure water tightness:
 - (i) shall be pressure tested at 50 pounds per square inch; or
 - (ii) all joints not meeting the 10 feet horizontal separation are to be further improved to prevent leakage using mechanically jointed non-flexible pipe couplings, concrete encasement, or other equivalent methods as approved by the Secretary.
 - (B) The sanitary sewer collection line or sanitary sewer service line shall be sleeved to a point 10 horizontal feet from the center line of the crossing.
 - (C) The sanitary sewer collection line is water main pipe or equivalent with the pipe centered over the water main and the joints of the pipe are 10 feet from the crossing.

§ 1-1008 Requirements for Wastewater Pump Stations

- (a) General requirements for wastewater pump stations:
 - (1) There shall be no physical connection between any potable water supply and a wastewater pump station.
 - (2) Pump stations with a design flow of 2000 gallons per day or larger shall be readily accessible by maintenance vehicles during all weather conditions.
 - (3) Pump station structures and electrical and mechanical equipment shall be protected from physical damage from a 100-year flood.
 - (4) Pump stations shall remain fully operational and accessible during a 25-year flood.
 - (5) Exterior access hatches shall be provided with locks.
 - (6) Where it is necessary to pump wastewater prior to grit removal, the wet well and pump station piping shall be designed to avoid operational problems from the accumulation of grit.
 - (7) Pump stations shall not be located within a building or structure except when the pump station is considered interior plumbing by the Vermont Plumbing Rules.
- (b) The design of a combination wet and dry well pump station, a submersible pump station, and a suction lift wastewater pump station shall meet the following additional requirements:
 - (1) Wastewater Pump Station Construction Materials
 - (A) Materials shall be selected that are appropriate under conditions of exposure to hydrogen sulfide and other corrosive gases, greases, oils, and other constituents frequently present in wastewater. This is particularly important in the selection of metals and paints.

- (B) Contact between dissimilar metals should be avoided. If contact cannot be avoided the design shall include provisions to minimize galvanic action.
- (C) Pump stations shall be watertight. All inlet and outlet pipes penetrations shall:
 - (i) for concrete tanks, be made with flexible rubber boots; or
 - (ii) for plastic or fiberglass tanks, be made with watertight rubber grommets.
- (2) The designer is responsible for ensuring the pump station, when it is located in the seasonal high groundwater, is provided proper anchors to prevent movement of the station.
- (3) Dry wells
 - (A) Dry wells, including their superstructure, shall:
 - (i) be completely separate from the wet well;
 - (ii) have all common walls with the wet well be water and gas tight;
 - (iii) not provide access to the wet well; and
 - (iv) for the pump equipment compartment dry well, be above grade or offset to the wet well.
 - (B) Dry wells shall have a sump with a sump pump to remove leakage or drainage. Dry wells shall be designed so that the sump pump:
 - (i) is equipped with dual check valves;
 - (ii) discharges the contents of the sump to the wet well;
 - (iii) has a pump discharge pipe terminating above the maximum high-water elevation of the wet well;
 - (iv) discharges all seal leakage via a pipe or channel directly to the sump; and
 - (v) is sized to remove the maximum pump seal water discharge that would occur in the event of a pump seal failure.
- (4) Wet Wells
 - (A) Size
 - (i) The design fill time and minimum pump cycle time shall be taken into account when sizing the wet well.
 - (ii) The effective volume of the wet well shall be based on design flow and a filling time not to exceed 30 minutes unless the facility uses flow equalization.
 - (iii) The pump manufacturer's duty cycle recommendations shall be used to determine the minimum cycle time.
 - (B) Access openings to the wet well:
 - (i) shall be at least 24 inches in diameter; and
 - (ii) shall have gasketed replacement plates maintained on site to cover the access opening to the wet well in the event that the existing cover plate needs replacing after its removal.
 - (C) Floor Slope
 - (i) The wet well floor shall have a minimum slope of 1 to 1 to the hopper bottom.
 - (ii) The horizontal area of the hopper bottom shall be not greater than necessary for proper installation and function of the inlet.
 - (D) Air Displacement (Venting)

- (i) Covered wet wells shall have provisions for air displacement to the atmosphere such as an inverted "j" tube or similar means.
- (5) Ventilation
- (A) General
 - (i) Adequate ventilation shall be provided for all pump stations. Where the dry well is below ground surface, mechanical ventilation is required.
 - (ii) If screens or mechanical equipment requiring maintenance or inspection are located in the wet well, permanently installed ventilation is required.
 - (iii) There shall be no interconnection between the wet well and dry well ventilation systems.
 - (B) Air Inlets and Outlets
 - (i) In dry wells over 15 feet deep, multiple inlets and outlets are desirable.
 - (ii) Dampers shall not be used on exhaust or fresh air ducts.
 - (iii) Fine screens or other obstructions in air ducts shall be avoided to prevent clogging.
 - (C) Electrical Controls
 - (i) All intermittently operated ventilation equipment shall be interconnected with the respective pit lighting system.
 - (ii) The manual lighting/ventilation switch shall override the automatic controls.
 - (D) Fans, Heating, and Dehumidification
 - (i) The fan wheel shall be fabricated from non-sparking material.
 - (ii) Automatic heating and dehumidification equipment shall be provided in all dry wells.
 - (iii) The electrical equipment and components shall meet the requirements in Subsection (f)(1) and (2).
 - (E) Dry Well Ventilation
 - (i) Ventilation may be either continuous or intermittent.
 - (I) If continuous, there shall be at least 6 complete air changes per hour.
 - (II) If intermittent, there shall be at least 30 complete air changes per hour.
 - (ii) A system of 2 speed ventilation with an initial ventilation rate of 30 changes per hour for 10 minutes.
 - (iii) The air change requirements shall be based on 100 percent fresh air.
 - (F) Wet Well Ventilation
 - (i) Ventilation may be either continuous or intermittent.
 - (I) If continuous, it shall provide at least 12 complete air changes per hour.
 - (II) If intermittent, it shall provide at least 30 complete air changes per hour.
 - (ii) Air shall be forced into the wet well by mechanical means rather than solely exhausted from the wet well.

- (iii) The air change requirements shall be based on 100 percent fresh air.
 - (iv) Portable ventilation equipment shall be provided for use at submersible pump stations and wet wells with no permanently installed ventilation equipment.
 - (v) For submersible pump stations receiving less than 20,000 gallons per day design flow, gravity ventilation is acceptable.
 - (vi) All wet wells shall have provisions for air displacement to the atmosphere such as an inverted "j" tube or similar means. Vents shall:
 - (I) open downward;
 - (II) terminate 24 inches above ground surface; and
 - (III) have a 24 mesh non-corrodible screen covering the vent opening.
- (c) The design of pumps shall meet the following requirements:
- (1) Protection Against Clogging
 - (A) Sanitary sewer collection lines that accept wastewater and stormwater shall have:
 - (i) pumps capable of handling the combined wastewater and stormwater;
 - (ii) pump screening;
 - (iii) trash racks;
 - (iv) grinders; or
 - (v) a combination of the components described in Subsection (c)(1)(A)(ii), (iii) and (iv) to protect the pumps.
 - (B) Sanitary sewer collection lines that are 30-inch or larger in diameter that accept only wastewater shall include the components identified in Subsection (1)(A)(ii), (iii), (iv) or (v).
 - (2) Wastewater pump stations receiving a design flow of less than 2000 gallons per day:
 - (A) may be equipped with a single pump provided that replacement pumps are readily available; and
 - (B) shall have one day's emergency storage above the high-water alarm level in the wet well.
 - (3) Multiple Pumps
 - (A) Wastewater pump stations receiving an average design flow of 2000 gallons per day or more shall have multiple pumping units.
 - (B) Multiple pumping units shall have the capacity so that, if any single unit is out of service, the remaining units will have the capacity to handle the peak hourly flow rate.
 - (4) For pumps handling raw or untreated wastewater, except where grinder pumps are used:
 - (A) the pumps shall be solid handling capable of passing spheres of at least 3 inches in diameter; and
 - (B) pump suction and discharge piping shall be at least 4 inches in diameter.
 - (5) Pumps handling only settled wastewater shall be capable of passing 1½ inch spheres.

- (6) The pump shall be placed so that, under normal operating conditions, it will operate under a positive suction head except as specified in Subsection (c)(12).
- (7) Intake
 - (A) Each pump shall have an individual intake.
 - (B) Wet wells shall be designed to avoid turbulence near the intake and to prevent vortex formation.
 - (C) Piping shall be as straight and short as possible.
 - (D) Where turned down bellmouth inlets or submersible pumps are used, the bottom of the intake shall be placed a sufficient distance above the wet well floor to minimize inlet head losses but close enough to the wet well floor to assure inlet velocities sufficient to prevent solids deposition.
- (8) Pumping Rates for Pump Stations Receiving 2000 gallons or more of Wastewater Per Day
 - (A) The pumps and controls of main pump stations shall be selected to operate at varying delivery rates.
 - (B) When possible, such stations shall be designed to deliver as uniform a flow as is technically practical in order to minimize hydraulic surges.
 - (C) The station design capacity shall be based on the peak hourly flow rate as determined by § 1-1003(c)(2) and be adequate to maintain a minimum velocity of 2 feet per second in the force main.
- (9) Pump Controls
 - (A) Bubbler type level monitoring systems shall include dual air compressors.
 - (B) Provision shall be made to automatically alternate the pumps when there are multiple pumps in use.
 - (C) The second pump “on” level and “alarm on” level shall be at the same elevation when there are multiple pumps in use.
- (10) Valves
 - (A) Suction Line
 - (i) Suitable shutoff valves shall be placed on the suction line of dry pit pumps.
 - (B) Discharge Line
 - (i) Suitable shutoff and check valves shall be placed on the discharge line of each pump.
 - (ii) The check valve shall be located between the shutoff valve and the pump.
 - (iii) Valves shall be capable of withstanding normal pressure and water hammer.
 - (C) Location of Valves
 - (i) All shutoff and check valves shall be operable from the floor level and accessible for maintenance. Outside levers are recommended on swing check valves.
 - (ii) Valves, except for valves associated with pump stations with a single pump, shall not be located in the wet well but shall be in a separate valve pit adjacent to the wet well. The valve pit shall:
 - (I) contain a valve connection to allow the use of a portable pump for the pump station; and
 - (II) be designed to remove or drain accumulated water from the valve chamber. The valve pit shall be dewatered to the wet

well through a drain line with a gas and watertight valve or be dewatered using a sump pump that discharges the water to the wet well. The design shall include an effective method of preventing wastewater from entering the pit during surcharged wet well conditions.

- (III) Valves associated with a pump station with a single pump shall be accessible without needing to enter the station.
 - (iii) Check valves that are integral to the pump and would be removed from the wet well with the pump do not need to be located in a separate valve chamber.
 - (iv) Valves may be located in wet wells only where single pump units are allowed. Valves shall be accessible without entering the wet well.
- (11) Submersible Pumps – Special Requirements
- (A) Submersible pumps shall be easily removable and replaceable without dewatering the wet well or disconnecting any piping in the wet well except when allowed for pump stations with a single pump.
 - (B) Submersible pumps and motors in a pump station not receiving septic tank effluent shall be designed specifically for raw or untreated wastewater use including totally submerged operation during a portion of each pumping cycle and shall meet the requirements of the National Electrical Code for such units. An effective method to detect shaft seal failure or potential seal failure shall be included in the design.
 - (C) Submersible pumps shall have a minimum pump run time of 5 minutes except when the Rules allow or require a pump time of less than 5 minutes, such as in § 1-914, § 1-915, § 1-916, and § 1-923.
- (12) Suction-Lift Pumps – Special Pump Priming and Lift Requirements
- (A) Suction-lift pumps shall be either self-priming or vacuum-primed.
 - (B) Calculations must include:
 - (i) static suction-lift as measured from "lead pump off" elevation to center line of pump suction;
 - (ii) friction and other hydraulic losses of the suction piping;
 - (iii) vapor pressure of the liquid;
 - (iv) altitude correction;
 - (v) required net positive suction head; and
 - (vi) an additional 6 feet of head.
 - (C) Self-Priming Pumps
 - (i) Self-priming pumps shall be capable of rapid priming and re-priming at the "lead pump on" elevation.
 - (ii) Such self-priming and re-priming shall be accomplished automatically under design flow operating conditions.
 - (iii) Suction piping shall not exceed the size of the pump suction and shall not exceed 25 feet in total length.
 - (iv) Priming lift at the "lead pump on" elevation shall include a minimum of 4 additional feet from the maximum allowable priming lift for the specific equipment at design flow operating conditions.

- (v) The combined total of dynamic suction-lift at the "pump off" elevation and required net positive suction head at design flow operating conditions shall not exceed 22 feet.
 - (D) Vacuum-Priming Pumps
 - (i) Vacuum-priming pump stations shall be equipped with dual vacuum pumps capable of automatically and completely removing air from the suction-lift pump.
 - (ii) The vacuum pumps shall be adequately protected from damage due to wastewater.
 - (iii) The combined total of dynamic suction-lift at the "pump off" elevation and required net positive suction head at design flow operating conditions shall not exceed 22 feet.
 - (E) Suction-lift pump stations using dynamic suction lifts exceeding the limits outlined in Subsection (c)(12)(C) and (D) may be used when the designer has the manufacturer's certification of pump performance and made calculations that indicate satisfactory performance under the proposed design flow operating conditions.
- (d) Requirements for Flow Measurement
- (1) Suitable devices for measuring wastewater flow shall be provided at all pump stations except as provided in Subsection (d)(3). Indicating, totalizing, and recording flow measurement meters shall be provided at pump stations with a peak hourly flow rate of 1200 gallons per minute or greater.
 - (2) Elapsed time meters used in conjunction with annual pumping rate tests may be acceptable for pump stations with a peak hourly flow rate up to 1200 gallons per minute, provided sufficient metering is configured to measure the duration of individual and simultaneous pump operation.
 - (3) Pump stations with a single pump receiving less than 2000 gallons of wastewater per day are exempt from the requirements of this Subsection.
- (e) Requirements for Equipment Removal
- (1) The design shall facilitate removal of pumps, motors, and other mechanical and electrical equipment.
 - (2) When there are multiple pumps, individual pump and motor removal shall not interfere with the continued operation of remaining pumps.
 - (3) Submersible pumps shall be easily removable and replaceable without personnel entering or dewatering the wet well or, for pump stations with multiple pumps, disconnecting any piping in the wet well.
 - (4) Pump stations with a single pump may allow pump removal using the discharge pipe from the pump, provided the coupling that allows the disconnection to the force main is accessible without entering the wet well.
 - (5) For suction-lift or vacuum primed pump stations, the following requirements shall be met:
 - (A) The pump equipment compartment shall be above grade or offset and shall be isolated from the wet well to prevent a hazardous and corrosive sewer atmosphere from entering the equipment compartment.
 - (B) Wet well access shall not be through the equipment compartment and shall be at least 24 inches in diameter.

- (C) Gasketed replacement plates shall be maintained on site to cover the opening to the wet well in the event that the existing cover plate needs replacing when a pump unit is removed for servicing.
- (f) Requirements for Electrical Equipment
- (1) Electrical systems and components (e.g. motors, lights, cables, conduits, switchboxes, control circuits, etc.) in raw or untreated wastewater wet wells, or in enclosed or partially enclosed spaces where hazardous concentrations of flammable gases or vapors may be present shall comply with the National Electrical Code® for Class I, Division 1, Group D, locations.
 - (2) Equipment located in the wet well shall be suitable for use under corrosive conditions.
 - (A) Each flexible cable shall be provided with a watertight seal and separate strain relief.
 - (B) A fused disconnect switch located above ground shall be provided for all pump stations.
 - (C) Lightning and surge protection systems shall be provided.
 - (D) A 110-volt power receptacle to facilitate maintenance shall be located inside the control panel for pump stations that have control panels outdoors.
 - (E) Ground Fault Circuit Interruption (GFCI) protection shall be provided for all outdoor outlets.
 - (3) Submersible Pump Stations – Special Requirements
 - (A) Power Supply and Control Circuitry
 - (i) Electrical supply, control, and alarm circuits shall be designed to provide strain relief and to allow disconnection from outside the wet well.
 - (ii) Terminals and connectors shall be protected from corrosion by location outside the wet well or through use of watertight seals.
 - (B) Controls
 - (i) The motor control center shall be:
 - (I) located outside the wet well;
 - (II) easily accessible; and
 - (III) protected by a conduit seal or other appropriate measures meeting the requirements of the National Electrical Code to prevent the atmosphere of the wet well from entering the control center.
 - (ii) The conduit seal shall be located so that the pump may be removed and electrically disconnected without disturbing the conduit seal.
 - (iii) When the control center is exposed to weather, it shall meet the requirements of weatherproof equipment of NEMA 3R or 4.
 - (C) Power Cord
 - (i) Pump motor power cords shall be designed for flexibility and serviceability under conditions of extra hard usage and shall meet the requirements of the National Electrical Code standards for flexible cords in wastewater pump stations.

- (ii) Ground fault interruption protection shall be used to de-energize the circuit in the event of any failure in the electrical integrity of the cord.
 - (iii) Power cord terminal fittings shall be:
 - (I) corrosion-resistant;
 - (II) constructed in a manner to prevent the entry of moisture into the cord;
 - (III) include strain relief appurtenances; and
 - (IV) designed to facilitate field connecting.
- (g) Requirements for Emergency Storage
 - (1) Emergency storage shall be provided for all pump stations except for pump stations:
 - (A) that have:
 - (i) a permanent independent engine generator that has sufficient capacity to start up and maintain the total rated running capacity of the pumps when the generator automatically starts up when there is a power outage; or
 - (ii) alternate electrical power source for electrically driven pumps; and
 - (B) where there are no down-stream pump stations that rely on storage.
 - (2) Storage shall be provided above the high-water alarm level of the wet well.
 - (A) Storage may be provided in the wet well, or in an adjacent tank that is designed to drain back into the wet well.
 - (B) For pump stations with multiple pumps, the volume of storage shall equal the design flow for a period in excess of the longest power outage in the last 5 years that would have affected the pump station or the design flow based on a 16-hour delivery rate divided by 4 hours, whichever is greater.
 - (C) Emergency storage shall be a minimum of one day of the design flow for all pump stations with a single pump.
 - (D) The emergency storage volume may overflow into the connecting sanitary sewer service line or sanitary sewer collection line provided the wastewater does not:
 - (i) back up into building basements or fixtures;
 - (ii) back up into septic tanks; or
 - (iii) flow over the top of manholes or the wet well.
- (h) Requirements for Alarm Systems
 - (1) Pump station alarm systems shall have a backup power source.
 - (2) The alarm, at a minimum, shall be activated in cases of:
 - (A) power failure;
 - (B) dry well sump high-water elevation;
 - (C) wet well high-water elevation;
 - (D) low water wet well level;
 - (E) pump failure;
 - (F) other causes of pump station malfunction;
 - (G) standby power failure; and
 - (H) except for a pump station with a single pump, unauthorized entry.
 - (3) Audio and visual alarms shall be located outside the pump station.

- (4) Pump stations with a single pump shall be provided an audio and visual alarm located at the pump station that is activated by the high-water elevation.

§ 1-1009 Requirements for Force Mains

- (a) Force mains shall meet the following requirements:
 - (1) Layout:
 - (A) Looping force main piping is prohibited.
 - (B) Pipe routing shall include long radius sweeps no less than those recommended by the pipe manufacturer.
 - (2) The force main shall be sized to maintain a minimum hydraulic velocity of 2.0 feet per second with one pump on.
 - (3) The minimum force main size shall be 1½ inch diameter when using a grinder pump.
 - (4) The minimum force main diameter for raw or untreated wastewater shall be 4 inches.
 - (5) An automatic air relief valve shall be placed at high points in the force main to prevent air locking.
 - (6) Vacuum relief valves may be necessary to relieve negative pressures on force mains. The force main configuration and head conditions shall be evaluated as to the need for and placement of vacuum relief valves.
 - (7) Air or vacuum relief valves shall be located in a manhole or structure to allow access for repair and maintenance.
 - (8) Maintenance Valves, Cleanouts, Isolation Valves, and Check Valves
 - (A) Isolation valves shall be installed where one force main connects into a second force main.
 - (B) Cleanouts shall be installed every 1500 to 2000 feet in all force mains.
 - (C) A valve box with a redundant check valve or equivalent shall be located:
 - (i) at the property line to protect buildings or structures from flooding when the building or structure connects to a pressure force main; or
 - (ii) on each force main upstream of the connection where 2 force mains join together.
 - (D) Isolation valves shall be provided on either side of a check valve so that the check valve can be removed for maintenance, repair or replacement.
 - (9) Force mains shall enter a gravity sanitary sewer manhole:
 - (A) at a point not more than 1 foot above the flow line of the receiving manhole: and
 - (B) so that flow is directed in a manner that protects the manhole and sewer line from scouring.
 - (10) Pipe Material
 - (A) Acceptable pipe material includes Class 200, SDR 21 PVC ; Class 160, SDR 26 or greater; or HDPE SDR 11 or equivalent.
 - (B) Pipe and joints shall be equal to piping and joints used for water mains.
 - (11) Force mains and fittings, reaction blocking, and pump station piping shall be designed to withstand water hammer pressures and associated cyclic reversal of stresses that are expected with the cycling of wastewater pump stations.

- (12) Friction losses in force mains shall be based on the Hazen Williams formula or other acceptable method. When the Hazen and Williams formula is used, the value for "C" shall be:
 - (A) 100 for unlined iron or steel pipe for design; and
 - (B) for other smooth pipe materials, such as PVC, polyethylene, lined ductile iron, etc., a higher "C" value not to exceed 120 may be allowed for design.
- (13) Force mains shall comply with § 1-1007 for separation to water services lines, water service pipes, or water mains.
- (14) Where force mains are constructed of material which might cause the force main to be confused with water services lines, water service pipes, or water mains, the force main shall be appropriately identified.
- (b) Upon completion of construction of a force main, the force main shall be pressure and leakage tested to ensure there are no leaks.
 - (1) Pressure Test
 - (A) All newly laid pipe or any valved section thereof shall be subjected to a hydrostatic pressure of at least 1.5 times the highest working pressure in the section in accordance with the following procedure:
 - (i) Test pressures shall:
 - (I) not be less than 50 pounds per square inch at the highest point along the test section;
 - (II) not exceed pipe or thrust restraint design pressures;
 - (III) be of at least 2-hour duration;
 - (IV) not vary by more than 5 pounds per square inch; and
 - (V) not exceed twice the rated pressure of the valves when the pressure boundary of the test section includes closed gate valves.
 - (B) Each valved section of pipe shall be filled with water slowly and the specified test pressure, based on the elevation of the lowest point of the line or section under test and corrected to test gauge, shall be applied by means of a pump connected to the pipe.
 - (C) Before applying the specified test pressure, air shall be expelled completely from the pipe and valves.
 - (D) All exposed pipe, fittings, valves, and joints shall be examined carefully during the test. Any damaged or defective pipe, fittings, or valves that are discovered following the pressure test shall be repaired or replaced with sound material and the test shall be repeated.
 - (2) Leakage Test
 - (A) A leakage test shall be conducted concurrently with the pressure test.
 - (B) Leakage shall be determined by the quantity of water that must be supplied into the newly laid pipe, or any valved section thereof, to maintain pressure within 5 pounds per square inch of the specified test pressure after the air in the pipeline has been expelled and the pipe has been filled.
 - (C) No pipe installation will be accepted if the leakage is greater than that determined by the following formula:

$$L = (N)(D)(\sqrt{P}) \div 7400$$
 where:
 L is the allowable leakage, in gallons per hour;

N is the number of joints in the length of pipeline tested;
D is the nominal diameter of the pipe, in inches; and
P is the average test pressure during the leakage test, in pounds per square inch gauge.

- (c) Force mains shall be covered with sufficient earth or other insulation to prevent freezing.

§ 1-1010 Requirements for Testing of Tanks for Watertightness

- (a) Septic tanks, dosing siphons, holding tanks, pump stations, wastewater storage tanks, wet wells, and grease tanks shall be watertight.
- (b) When required to be tested for watertightness by a permit, tanks shall be tested using the ASTM for testing of tanks or the following:
- (1) For concrete tanks, complete one of the following tests:
 - (A) Using a water pressure test, seal the tank and risers, fill with water to the top of the risers, and let stand for 24 hours. Refill the tank. The tank is considered watertight if the water level is held for 1 hour.
 - (B) Using a vacuum test, seal the empty tank and risers and apply a vacuum to 2 inches (50 mm) of mercury. The tank is considered watertight if 90 percent of the vacuum is held for 2 minutes.
 - (2) For plastic or fiberglass tanks, fill the tank up to the top of the risers with water for 1 hour. The tank is considered watertight if there is no drop in the water level.
 - (3) For steel tanks, fill the tank up to the top of the risers with water for 1 hour. The tank is considered watertight if there is no drop in the water level.

Subchapter 11 – Specific Technical Standards for Potable Water Supplies

§ 1-1101 Use of Term Potable Water Supply

The term potable water supply as used in this Subchapter shall mean a potable water supply that includes a potable water source (i.e., as used in this Subchapter, the term potable water supply shall not include water service lines).

§ 1-1102 General Requirements for Potable Water Supplies and Water Service Lines

- (a) Except when the potable water supply serves only one single-family residence, a potable water supply shall include a potable water source with a long-term yield that is capable of supplying the design rate necessary to accommodate the design flow associated with each component of the potable water supply.
- (b) A building or structure shall be served by no more than one potable water source unless:
 - (1) the Secretary determines, based on information provided by the applicant's designer, that more than one source is required to meet the design flow for the building or structure; or
 - (2) none of the potable water supply presumptive isolation zones for the potable water sources serving the building or structure extend onto land owned by a person different than the owner of the building or structure.
- (c) A potable water source shall either:
 - (1) be demonstrated to have sufficient yield to meet the design rate without adversely interfering with existing or permitted public water sources or potable water sources through a long-term yield analysis conducted pursuant to the requirements of § 1-1107 and interference testing and analysis, if required, conducted pursuant to the requirements of § 1-1108; or
 - (2) be demonstrated to have a high probability of yielding a sufficient quantity of water to meet the design rate without adversely interfering with existing or permitted public water sources or potable water sources based on the yields of surrounding wells.
- (d) A surface water potable water source shall meet the following requirements:
 - (1) A surface water potable water source shall serve only one building or structure that is a single-family residence occupied by the owner of record. The single-family residence may include a home occupation as that term is defined in these Rules but the residence may not be used in any other way, including uses that employ persons other than family members and involve visits by the public in a manner or duration that would presume the need for use of a potable water supply.
 - (2) The only surface waters that may be used as potable water sources are lakes and ponds that the Watershed Management Division has determined to be not impaired and Lake Champlain, excluding St. Albans Bay, Missisquoi Bay, and portions from the Lake Champlain Bridge south. Streams shall not be used.
- (e) The construction, installation, or hydrofracturing of a groundwater potable water source,

except the construction of a potable water supply using surface water, that is equal to or greater than 20 feet deep shall be performed by a well driller.

- (f) The minimal working pressure in water service lines and water service pipes shall be:
 - (1) 35 pounds per square inch at the main if connecting to a public water system;
 - (2) 20 pounds per square inch at the ground level at the foundation wall; and
 - (3) 8 pounds per square inch at the highest elevation fixture.

§ 1-1103 Source Siting Requirements

- (a) A potable water source shall not be located:
 - (1) In a floodway.
 - (2) In Zone 1 of a Public Community Water System Source Protection Area.
 - (3) In an area classified by the Secretary as a Class IV groundwater area unless the Secretary has authorized use of the groundwater as a source for a potable water supply under a reclassification order.
- (b) A potable water source, located in a flood hazard area, shall be located, designed, and constructed in a manner that avoids impairment to the source and contamination of the source during flooding.

§ 1-1104 Horizontal Isolation Distances and Isolation Zones for Components of Potable Water Supplies

- (a) Table 11-1 identifies the minimum horizontal isolation distance that all portions of each identified component of a potable water supply shall be located from all portions of the identified potential sources of contamination, unless the Secretary has authorized a reduction to the isolation distance or increased the isolation distance pursuant to Subsections (k) or (l).
- (b) Isolation distances between potable water sources and injection wells required to have a permit that are within 1000 feet of each other shall be established on a case-by-case basis taking into consideration the following information provided by a designer:
 - (1) the contaminants expected from the injection well and their constituents;
 - (2) expected soil treatment; and
 - (3) site specific conditions including ground slope and groundwater flow direction.
- (c) Isolation distances between potable water sources and a site listed on the hazardous sites list maintained by the Waste Management and Prevention Division of the Department that are within one third of a mile of each other shall be established on a case-by-case basis.
- (d) Isolation distances between potable water sources, water service pipes, water service lines, and water storage tanks and potential sources of contamination not identified in Table 11-1 or in Subsections (b) or (c) shall be established on a case-by-case basis taking into consideration the following information provided by a designer:
 - (1) the potential contaminants and their constituents;
 - (2) expected soil treatment;

- (3) site specific conditions including ground slope and groundwater flow direction; and
- (4) design standards that may protect the source or service from contamination.

**Table 11-1
Horizontal Isolation Distances, in Feet for Potential Sources of Contamination**

Potential Source of Contamination	Potable Water Sources in Bedrock or Confined Surficial Aquifer	Potable Water Sources in Unconfined Surficial Aquifer	Water Service Lines and Water Service Pipes (Pressure)	Water Service Lines and Water Service Pipes (Suction)	Water Storage Tanks (Atmospheric Below Ground Surface)
Agriculture cropland	100	200	25	100	50
Buildings or structures, porches, foundations of buildings or structures	5	5	N/A	N/A	N/A
Cemeteries	100	150	25	100	50
Composting sites (commercial or agricultural) ¹	200	300	25	300	50
Concentrated livestock holding areas barnyard ²	200	500	25	100	50
Driveways (fewer than 3 residences)	5	10	N/A	N/A	10
Driveways (3 or more residences), roadways, parking lots	25	25	N/A	N/A	25
Fertilizer or pesticide storage structures (buried tank of any size; above ground tank >1,500 gallons; dry or liquid; and piping serving a non-residential facility)	100	200	50	200	50
Fuel oil, gasoline & other petroleum tanks and piping (not including liquefied petroleum gas tank)	25	100	25	100	50
Herbicide or pesticide application on utility right of way where herbicides or pesticides either have been applied in the last 12 months or may be applied within the next 12 months ³	100	200	25	200	100

Potential Source of Contamination	Potable Water Sources in Bedrock or Confined Surficial Aquifer	Potable Water Sources in Unconfined Surficial Aquifer	Water Service Lines and Water Service Pipes (Pressure)	Water Service Lines and Water Service Pipes (Suction)	Water Storage Tanks (Atmospheric Below Ground Surface)
Leachfields (proposed, existing, or permitted)	Requires isolation zone (See Table 11-2)		25	100	50
Manure storage systems, above ground ²	50	100	25	50	50
Manure storage systems, in-ground concrete or geosynthetic lined ²	100	200	25	200	100
Manure storage system, earthen lined ²	200	500	25	200	200
Property lines	10	10	N/A	N/A	10
Salvage yards ⁴	300 ⁸	300 ⁸	25	300	100
Sanitary sewer collection lines and sanitary sewer service lines	50	75	Distances and requirements established in § 1-1204 apply in lieu of this Section		50
Silage storages	50	75	25	75	50
Solid waste transfer facilities ⁵	100	200	25	200	100
Stormwater conveyance/treatment/control practice (lined)	10	10	10	10	10
Stormwater conveyance/treatment/control practice (unlined and subsurface systems)	100	150	10	150	25
Storm sewers	10	50	Distances and requirements established in § 1-1204 apply in lieu of this Section	Distances and requirements established in § 1-1204 apply in lieu of this Section	10
Surface water, normal high water elevation ⁶	10	25	N/A	N/A	25
Wastewater disposal spray area and lagoons	200	300	50	300	100
Wastewater tanks (proposed, existing, or permitted) ⁷	Requires isolation zone (See Table 11-2)		25	50	50

¹ Isolation distances for composting sites (commercial or agricultural) shall be measured from the perimeter of the composting area or area used for storage of composted material.

² Isolation distances for concentrated livestock holding areas and manure storage systems shall be measured from the perimeter of the holding area or outside perimeter of the manure storage system.

³ Isolation distances for herbicide or pesticide application on utility right of way where herbicides or pesticides either have been applied in the last 12 months or may be applied within the next 12 months shall be measured from points of application of the herbicide or pesticide.

⁴ Isolation distances for salvage yards shall be measured from the perimeter of the area used for the storage of salvaged materials to the component.

⁵ Isolation distances for solid waste transfer facilities shall be measured from points within the transfer facility used for storing solid waste.

⁶ The horizontal location to surface water shall allow for possible future widening of the surface water due to bank erosion.

⁷ Wastewater Tanks include septic tanks, pump stations, dosing siphons, holding tanks, wastewater storage tanks, wastewater treatment tanks, sand filters, constructed wetlands, and grease tanks.

⁸ If the applicant's designer demonstrates that the groundwater flow from the salvage yard is not in the direction of the potable water source, the isolation distance shall be 100 feet rather than 300 feet.

- (e) Subsections (f), (g), (h), and (i), in conjunction with Table 11-2, identify the size and shape of the isolation zone around the identified components of proposed, existing, or permitted wastewater systems, and proposed or permitted replacement areas, in which no portion of a potable water source shall be located, unless the Secretary has authorized a reduction to the isolation zone or required a larger isolation zone pursuant to Subsections (k) or (l).

**Table 11-2
Distances, in Feet, Used to Create Isolation Zones Around Components of Wastewater
Systems and Replacement Areas**

Drinking Water Sources (by gallons per minutes design rate)		Proposed, Existing, or Permitted Leachfields and Proposed or Permitted Replacement Areas (< 2000 gallons per day design flow)	Proposed, Existing, or Permitted Leachfields and Proposed or Permitted Replacement Areas (≥ 2000 to < 6500 gallons per day design flow)	Proposed, Existing, or Permitted Leachfields and Proposed or Permitted Replacement Areas (≥ 6500 gallons per day or more design flow)	Proposed, Existing, or Permitted Wastewater Tanks ¹
Potable water sources in bedrock or confined surficial aquifer	≤ 2.0	X = 100 Y = 200	X = 150 Y = 300	X = 200 Y = 1000	X = 50 Y = 50
	> 2.0 and ≤ 5.0	X = 150 Y = 300	X = 150 Y = 300	X = 200 Y = 1000	
	> 5.0 and ≤ 8.0	X = 200 Y = 400	X = 200 Y = 400	X = 200 Y = 1000	
	> 8.0	X = 200 Y = 1000			
Potable water sources in an unconfined surficial aquifer	≤ 8.0	X = 150 Y = 500	X = 150 Y = 1000	X = 200 Y = 1000	X = 75 Y = 75
	> 8.0	X = 200 Y = 1000			

¹ Wastewater Tanks include septic tanks, pump stations, dosing siphons, holding tanks, wastewater storage tanks, wastewater treatment tanks, sand filters, constructed wetlands, and grease tanks.

- (f) One of the following methods shall be used in conjunction with the points identified in Subsection (h) to determine the size and shape of the required isolation zone around proposed, existing, or permitted leachfields, and proposed or permitted replacement areas, with X and Y equaling the numbers identified in Table 11-2:
- (1) Draw an arc so that all points of the arc are Y from all portions of the component.
 - (2) Use the ground surface contours (not artificial modifications, such as roadways, filled areas, or retaining walls) to draw the following arcs to create a complete zone around all portions of the component:
 - (A) Beginning at the 2 upslope corners of the component, swing an arc to the outside of the system with a radius of X to create a point where the arcs intersect with the same contour as the 2 upslope corners of the component.

- (B) Continue the 2 arcs in the upslope direction to a point that is X upslope of each corner of the component.
 - (C) Connect the 2 arcs with a tangent line so that no portion of the arcs or tangent line are less than X from the component.
 - (D) Beginning at the 2 downslope corners of the component, swing an arc to the outside of the system with a radius of X to a point where the arcs intersect with the same contour as the 2 lowermost corners of the component.
 - (E) Connect the 2 points derived in Subsections (f)(2)(A) and (D) with a line so that the tangent line maintains a minimum of X beyond either side of the component.
 - (F) From each of the 2 downslope corners of the component, draw a “fall line,” a line oriented perpendicular to the topographic contours, to a point that is a minimum of Y from each corner.
 - (G) Beginning at the 2 points derived in Subsections (f)(2)(D), draw lines that are X from and parallel to the 2 fall lines.
 - (H) From each of the 2 downslope corners of the component and in the downslope direction, draw an arc with a radius of Y to connect the farthest downslope lines drawn in Subsections (f)(2)(F) and (G).
 - (I) Connect the 2 points derived in Subsections (f)(2)(F) with a tangent line so that no point of the tangent line is less than Y from the downslope side of the component.
 - (J) If the component is irregularly shaped, no portion of component shall be less than X in the upslope direction or along the same contour of the component, and, Y in the downslope direction of the component.
- (g) Notwithstanding Subsection (f), when a 2-year time of travel management zone is determined for a proposed, existing, or permitted leachfield, the size and shape of the required isolation zone around the leachfield shall be the 2-year time of travel management zone, provided:
- (1) When the drinking water source to be isolated from the leachfield is grouted, in no case shall any point along the isolation zone be less than 50 feet from the drinking water source.
 - (2) When the drinking water source to be isolated from the leachfield is not grouted, in no case shall any point along the isolation zone be less than 100 feet from the drinking water source.
- (h) Notwithstanding Subsection (f), where detailed topographical data is not available, the size and shape of the required isolation zone around proposed, existing, or permitted leachfields shall be determined using the method described in Subsection (f)(1).
- (i) The following points shall be used in conjunction with Subsection (f), (g), and (h) to identify the required isolation zones around proposed, existing, or permitted leachfields:
- (1) For in-ground leachfields, the corners of the outermost edges of the leachfield.
 - (2) For a leachfield in a mound, the corners of the effective basal area of the mound.
 - (3) For at-grade leachfields, the corners of the leachfield stone or other application surface.

- (4) For leachfield in a bottomless sand filter, the corners of the enclosure for a bottomless sand filter system.

- (j) The method to determine the size and shape of the required isolation zone around proposed, existing, or permitted wastewater tanks shall be to draw an arc around each tank so that all points of the arc are X, identified in Table 11-2, or greater from all portions of the tank.

- (k) An applicant or prospective applicant may submit a written request to the Secretary for a reduction in the required isolation distances or isolation zone for a particular potential source of contamination.
 - (1) The Secretary shall authorize the use of a reduced isolation distance or isolation zone between a potable water source and a particular potential source of contamination when the Secretary determines that the isolation distance specified in Table 11-1 or the isolation zone identified pursuant to Subsection (f) is unnecessary to protect human health because the specific site conditions, or the construction techniques and pipe materials for the potable water supply or wastewater system will prevent the performance of the potable water supply from being impacted by the potential source of contamination.
 - (2) In determining whether to authorize the use of a reduced isolation distance or isolation zone between a potable water source and a potential source of contamination specified in Table 11-1, the Secretary shall consider the following factors:
 - (A) the constituents of the potential contamination;
 - (B) the expected soil treatment; and
 - (C) site specific conditions.
 - (3) The Secretary may authorize the use of a reduced isolation distance between a water service line or water service pipe and a potential source of contamination listed in Table 11-1 when one or more of the following conditions exist:
 - (A) The water service line or water service pipe is installed in a sleeve that is determined to be watertight to prevent the introduction of the contaminant into the sleeve.
 - (B) The site-specific conditions indicate that the groundwater flow direction is from the water service line or water service pipe to the potential source of contamination.
 - (C) The site-specific conditions indicate that the seasonal high-water table is a minimum of 18 inches below the bottom of the water service line or water service pipe.
 - (4) The Secretary shall not authorize a reduction to the distances used to create an isolation zone around a leachfield pursuant to Subsection (f) to less than the following:
 - (A) When a hydrogeological analysis is not completed, the groundwater flow is not analyzed, and the water source is not grouted, X and Y shall not be reduced.
 - (B) When a hydrogeological analysis is not completed and when there is a continuous impeding layer from the leachfield to the potable water source, and the water source is grouted, X and Y shall not be less than 100 feet.

- (C) When groundwater flow from beneath a leachfield is not towards the potable water source, Y shall not be less than X.
 - (D) When a hydrogeological analysis is completed that reveals that groundwater flow from beneath a leachfield does not flow toward the potable water source under pumping conditions, Y shall be not less than 100 feet.
 - (E) When a hydrogeological analysis is completed that demonstrates there is at least a 2-year time of travel between a leachfield and the potable water source and the source is not grouted, Y shall not be less than 100 feet.
 - (F) When a hydrogeological analysis is completed that demonstrates there is at least a 2-year time of travel between a leachfield and the potable water source and the source is grouted, X and Y shall not be less than 50 feet.
- (5) The burden shall be on the applicant or prospective applicant to provide information from a designer that addresses the factors in Subsection (k)(2) or the conditions in (k)(3) and enables the Secretary to reach a determination.
 - (6) The Secretary's determination shall be in writing and indicate the reduced isolation distance or isolation zone.
- (l) The Secretary shall require a greater isolation distance or larger isolation zone for a particular potential source of contamination when the Secretary determines that, based on the specific site conditions described in an application, a greater isolation distance or larger isolation zone is necessary to prevent the potential subsurface flow of contaminant from impacting the performance of the potable water supply.

Note: Appendix C, Figure C-15, depicts an example for drawing an isolation zone around a leachfield.

§ 1-1105 Potable Water Supply Presumptive Isolation Zone

- (a) A presumptive isolation zone shall be identified, using the methods identified in § 1-912, around proposed potable water sources in which a leachfield with a design flow of less than 2000 gallons per day is presumed to be unable to be located.
- (b) Each potable water supply's presumptive isolation zone identified pursuant to Subsection (a) shall be considered in conjunction with the requirements of § 1-307 to determine if notification to adjacent landowners is required pursuant to § 1-307 and considered in conjunction with the requirements of Appendix A to determine if the potable water supply presumptive isolation zone is required to be shown on the site plan.

§ 1-1106 Grouting Annular Space

- (a) The annular space around the casing or well tile of a groundwater potable water source shall be grouted using the methods identified in § 1-1205(j) when:
 - (1) A reduction in the isolation zone between a leachfield and the potable water source is granted pursuant to § 1-1104(k) or § 1-912(e) and the Secretary requires grouting as a condition of the reduction.
 - (2) The Secretary determines there are site factors that require grouting to protect the potable water source from possible contamination.

- (b) Grouting is recommended if a potable water source may, in the future, require a public water system source permit under the Vermont Water Supply Rule.
- (c) When grouting is not required, the annular space of a potable water source shall be filled with native materials such as drill cuttings except for wells that do not have annular space, including concentric, dual rotary, eccentric, and drill and drive wells when the pilot hole is no larger than the drill hole for the casing.

§ 1-1107 Long-Term Yield Analysis

- (a) Except as provided in Subsection (b), the long-term yield for a potable water source with a design rate of 5 gallons per minute or less equals 50 percent of the well driller's estimated yield.
- (b) A long-term yield analysis of a potable water source shall be conducted for the following sources to establish the long-term yield:
 - (1) potable water sources with a design rate of more than 5 gallons per minute;
 - (2) potable water sources with a design rate greater than 50 percent of the well driller's estimated yield, except when the potable water supply serves only one single-family residence;
 - (3) potable water sources that gravity flow to a potable water pipe, except when the potable water supply serves only one single-family residence; and
 - (4) potable water sources, including a potable water source serving only one single-family residence, that are required to conduct interference testing and analysis pursuant to § 1-1108.
- (c) A long-term yield analysis conducted for the potable water sources identified in Subsection (b)(1), (2), and (4) shall comply with the following requirements:
 - (1) The long-term yield analysis shall consist of a constant discharge pumping test and recovery completed and analyzed by a hydrogeologist or a Class 1 designer.
 - (2) The duration of the constant discharge pumping test shall comply with Table 11-3 at a pumping rate greater than or equal to the required design rate of the source.
 - (3) The hydrogeologist or Class 1 designer shall:
 - (A) During the constant discharge pumping test, measure and record the water elevation drawdown and rate of discharge using accepted methods at intervals that will plot evenly on a logarithmic scale graph.
 - (B) Continue to measure and record the water elevation into the recovery period for 2 days, or until a minimum of 90 percent recovery is achieved, whichever occurs first.
 - (C) Determine the static water elevation, pump elevation, total available head, predicted drawdown, and remaining available head (the difference between the total available head and predicted drawdown).
 - (D) Estimate a long-term yield that meets or exceeds the following criteria:
 - (i) a constant withdrawal at the design rate for 180 days; and
 - (ii) a drawdown that shall not exceed 90 percent of the total available head.

**Table 11-3
Constant Discharge Pumping Test Duration**

Design rate of Potable Water Source (gallons per minute)	Minimum Test Length (Hours)
≤ 2.0	24
> 2.0 and ≤ 5.0	36
> 5.0 and ≤ 8.0	48, or 72 if there is unacceptable interference identified in the first 48 hours between the potable water source being tested and the public water source or potable water source
> 8.0 and ≤ 50	72
> 50 and < 100	96
100 gallons per minute or greater	120

- (d) A long-term yield analysis conducted for the potable water sources identified in Subsection (b)(3) shall comply with the following requirements:
- (1) The long-term yield analysis shall be conducted by a hydrogeologist or a Class 1 designer and shall include a prediction of the long-term yield based on the monitoring data.
 - (2) The method for conducting the long-term yield analysis shall be prepared by a hydrogeologist or Class 1 designer and shall be submitted to and approved by the Secretary prior to conducting the analysis.
 - (3) The long-term yield analysis shall be conducted during the lowest flow that may be expected during the calendar year.

§ 1-1108 Interference Testing and Analysis

- (a) For the purposes of this Section, “unacceptable interference” means when a potable water source causes:
- (1) an existing or permitted potable water source to be unable to meet the design rate or existing yield, whichever is lower; or
 - (2) an existing or permitted public water source to be unable to meet the authorized demand or permitted yield, whichever is greater.
- (b) A potable water source shall not create unacceptable interference with an existing or permitted public water source or potable water source.
- (c) If a potable water source is located within the distances specified in Table 11-4 to an existing or permitted public water source, interference testing shall be conducted in conformance with the Water Supply Rules to determine whether the potable water source will create unacceptable interference.

- (d) If a potable water source is located within the distances specified in Table 11-4 to an existing or permitted potable water source, interference testing shall be conducted that complies with the following requirements:
- (1) a hydrogeologist or Class 1 designer shall monitor the existing or permitted potable water sources for interference while conducting a long-term yield analysis on the proposed potable water source conducted pursuant to the requirements of § 1-1107; or
 - (2) when the owner of the existing or permitted potable water source has refused permission to monitor the source, it is otherwise not feasible to access the source, or, when the source is permitted but not existing, the source shall be analyzed by a hydrogeologist for potential interference using one of the following:
 - (A) the results of interference testing on other similar sources in the area; or
 - (B) calculations using text book values for aquifer parameters if no interference testing data is available.
- (e) The Secretary may waive the requirement to complete interference testing pursuant to Subsection (c) or (d) for a particular existing or permitted public water source or potable water source when the applicant provides information from a designer that demonstrates:
- (1) the yield for the existing or permitted potable water source will not be reduced below its design rate or existing yield, whichever is lower;
 - (2) the yield for the existing public water source will not be reduced below its authorized demand or permitted yield, whichever is greater; and
 - (3) well completion information for existing or permitted potable water source and public water sources located within the distances in Table 11-4 of the subject well supports the designer's opinion there is a sufficient quantity of water to supply the project without causing unacceptable interference with the existing potable or public water sources.

Table 11-4
Monitoring Distance from Test Source to a Potable or Public Water Source

Design Rate of Tested Source (gallons per minute)	Monitoring Distance (Feet)
≤ 2	100
> 2 and ≤ 5	300
> 5 and ≤ 20	1000
> 20 and ≤ 50	2000
$> 50 < 100$	2500
100 or greater	3000

- (f) Unacceptable interference identified through interference testing conducted pursuant to Subsection (c) or (d) may be resolved by:
- (1) drilling the affected source deeper and re-conducting interference testing;
 - (2) hydrofracturing the affected source and re-conducting interference testing;
 - (3) closing of the affected source; or
 - (4) another method approved by the Secretary.

§ 1-1109 **Instantaneous Peak Demand**

- (a) A potable water supply shall be capable of supplying the instantaneous peak demand associated with each component of the potable water supply, except as provided in Subsection (d).
- (b) A potable water supply's instantaneous peak demand shall be calculated using the following methods:
 - (1) the methodology in the Vermont Plumbing Rules;
 - (2) 5 gallons per minute multiplied by the number of living units; or
 - (3) a different methodology approved by the Secretary that is accepted by the AWWA or similar national publication.
- (c) A potable water supply with an instantaneous peak demand that is equal to or less than the long-term yield for the potable water source complies with the requirements of Subsection (a).
- (d) A potable water supply serving only one of the following is not subject to Subsections (a) and (e) when a pump is provided at the potable water source capable of supplying the potable water supply's instantaneous peak demand:
 - (1) a single-family residence;
 - (2) a single-family residence with an attached 1 bedroom living unit that uses the same potable water source with a total design flow of 560 gallons per day or less; or
 - (3) a building or structure with non-residential uses and a design flow of 560 gallons per day or less with an instantaneous peak demand of less than 15 gallons per minute.
- (e) Except as provided in Subsection (d), when a potable water supply's instantaneous peak demand exceeds the long-term yield for the potable water source, and the potable water source is pumped:
 - (1) the potable water supply shall include water storage that enables the potable water supply to meet the instantaneous peak demand and that complies with the requirements of § 1-1110; or
 - (2) an abbreviated constant discharge pumping test using one of the following methods shall be conducted that demonstrates the potable water source can provide the quantity of water necessary to meet the instantaneous peak demand of the potable water supply:
 - (A) The source is pumped at the potable water supply's instantaneous peak demand rate or greater for a duration where the total volume pumped equals twice the design flow and:
 - (i) the pumping test is supervised by a hydrogeologist, a Class 1 designer, Class BW designer, or well driller; and
 - (ii) the pump discharge rate is measured and recorded at 30-minute intervals with a minimum of 3 readings.
 - (B) A 3-hour blow test with flow measurements at less than or equal to 30-minute intervals is performed by a well driller.

- (C) A well driller's estimated yield is determined by methods other than Subsection (e)(2)(A) or (e)(2)(B) that is divided by 2.
 - (D) Another method for testing the potable water source approved by the Secretary is completed.
- (f) When a potable water supply's instantaneous peak demand exceeds the long-term yield for the potable water source, and the potable water source is not pumped (i.e., gravity flow to a potable water pipe), the potable water supply shall include water storage that enables the potable water supply to meet the instantaneous peak demand and that complies with the requirements of § 1-1110.

§ 1-1110 Water Storage and Water Storage Tanks

- (a) The base of a water storage tank shall be placed at or above the base flood elevation.
- (b) When water storage is required pursuant to § 1-1109:
 - (1) The required water storage volume shall be identified using the following calculations:
 - (A) If the long-term yield equals or exceeds $2/3^{\text{rds}}$ of the design rate but is less than the design rate, storage shall equal the design flow.
 - (B) If the long-term yield equals or exceeds the design rate:
 - (i) storage shall equal 55 percent of the design flow; or
 - (ii) storage shall be calculated using the equation $S = D [1 - Y/P]$ where:
 - (I) S = volume of water storage (gallons);
 - (II) D = design flow multiplied by 1 day (gallons);
 - (III) P = potable water supply's instantaneous peak demand (gallons per minute); and
 - (IV) Y = long-term yield or the results of the abbreviated constant discharge pumping test (gallons per minute).
 - (2) For drilled or driven wells, all, or a portion of, the required water storage volume may be met through the available casing storage identified using the following calculations:
 - (A) The total available head shall be calculated using the equation $TAH = PCL - SL$ where:
 - (i) TAH = total available head (feet);
 - (ii) PCL = pump cut-off level measured below top of casing (feet); and
 - (iii) SL = static level measured below top of casing (feet).
 - (B) The approximate drawdown elevation shall be calculated using the equation $DL = SL + (TAH \times (DR/Y))$ while pumping at the design rate where:
 - (i) DL = drawdown level measured below top of casing (feet);
 - (ii) SL = static level measured below top of casing (feet);
 - (iii) TAH = total available head (feet);
 - (iv) DR = design rate (gallons per minute); and
 - (v) Y = Long-term yield (gallons per minute).
 - (C) The remaining available head shall be calculated using:

- (i) In all circumstances other than that in Subsection (b)(2)(C)(ii), the equation $RAH = PCL - DL$ where:
 - (I) RAH = remaining available head (feet);
 - (II) PCL = pump cut-off level measured below top of casing (feet); and
 - (III) DL = drawdown level measured below top of casing (feet).
- (ii) When the source is a flowing artesian well and the drawdown elevation remains above the top of casing when pumping at the design rate, the equation $RAH = PCL$ where:
 - (I) RAH = remaining available head (feet); and
 - (II) PCL = pump cut-off level measured below top of casing (feet).
- (D) The available storage in the well shall be calculated using the equation $AS = \pi \times r^2 \times RAH \times 7.48$ where:
 - (i) AS = Available storage (gallons);
 - (ii) $\pi = 3.14$
 - (i) r = casing inside radius (feet); and
 - (ii) 7.48 (gallons per cubic foot).
- (3) For dug wells or springs, all, or a portion of, the required water storage volume may be met through the available storage in well tiles identified using the following calculations:
 - (A) For round well tiles, the equation $WTS = 1/2 (LWL - PCL)(\pi \times r^2)(7.48)$, where:
 - (i) WTS = available well tile storage (gallons);
 - (ii) LWL = annual low water level measured below the top of the tile (feet);
 - (iii) PCL = pump cut-off level or outlet measured below the top of the tile (feet);
 - (iv) $\pi = 3.14$;
 - (v) r = radius of the inside dimension of a round tile (feet); and
 - (vi) 7.48 (gallons per cubic foot).
 - (B) For square or rectangular well tiles, the equation $WTS = 1/2 (LWL - PCL)(L)(W)(7.48)$ where:
 - (i) WTS = available well tile storage (gallons);
 - (ii) LWL = annual low water level measured below the top of the tile (feet);
 - (iii) PCL = pump cut-off level or outlet measured below the top of the tile (feet);
 - (iv) L = length of the inside dimension of a rectangular tile (feet);
 - (v) W = width of the inside dimension of a rectangular tile (feet); and
 - (vi) 7.48 (gallons per cubic foot).
- (c) The portion of the required water storage volume not met by casing storage, if allowed pursuant to Subsection (b)(2), or storage in well tiles if allowed pursuant to Subsection (b)(3), shall be met through a combination of hydropneumatic tanks and other water storage tanks.

- (d) The storage volume provided by hydropneumatic tanks, when used to provide all or a portion of the required water storage volume, shall be calculated based on the volume of water available between the pump-on pressure and the minimum operating pressure for the distribution system to supply a minimum of 8 psi to all plumbing fixtures.
- (e) Hydropneumatic tanks (i.e., pressure tanks) shall meet the following requirements:
 - (1) Hydropneumatic tanks shall meet the requirements of the Vermont Plumbing Rules for hydropneumatics tanks and shall:
 - (A) be located in a building or structure;
 - (B) have the minimum working pressure at the hydropneumatic tank system set at 20 psi;
 - (C) have pressure reducing devices on the distribution system prior to the hydropneumatic tank when static pressures exceed 100 psi;
 - (D) have a drain, pressure gauge, watertight glass if applicable, and automatic or manual means for adding air, air blow-off, and pressure operated start-stop controls for pumps; and
 - (E) have a drain or overflow discharge pipe that:
 - (i) opens downward a minimum of 18 inches above a splash plate when discharging to ground surface; or
 - (ii) has an air-gap between the pipe and a sanitary sewer service line, sanitary sewer collection line, or storm drain when discharging to a line or drain. No drain or overflow pipe shall physically connect to any sanitary sewer service line, sanitary sewer collection line, or storm drain.
 - (2) Hydropneumatic tank storage shall be not used for fire protection purposes.

§ 1-1111 Pumps

- (a) A potable water supply that does not include an atmospheric water storage tank shall have a pump at the potable water source capable of supplying the instantaneous peak demand, unless the potable water supply is proposed to serve only one single-family residence.
- (b) A potable water supply that includes an atmospheric water storage tank shall have a pump at the potable water source capable of supplying the design rate and a pump at the water storage tank capable of supplying the instantaneous peak demand, unless the potable water supply is proposed to serve a single family-residence.
- (c) Pumps shall be sized based on a hydraulic analysis that considers flow, demand, and pressure requirements.
- (d) Booster pumps shall not be used in a building or structure that is connected to a water service line unless the booster pump design is approved in writing by the Secretary prior to installation. A booster pump design shall include:
 - (1) an appropriately sized air gap in the water service line between the booster pump and the water main; or

- (2) for buildings and structures other than single-family residences, an appropriately sized back flow prevention device in the water service line between the booster pump and the water main.

§ 1-1112 Cross Connections

- (a) There shall be no connection between:
 - (1) Any component of a public water system and a potable water source or other components of the potable water supply.
 - (2) A well that is not a potable water source (e.g., irrigation wells and wells used for closed loop geothermal systems) and a potable water source or other components of the potable water supply.
 - (3) A well used for an open loop geothermal system and a potable water source, unless the requirements in Subsection (b) are met.
 - (4) Any pipes, pumps, or tanks that would allow non-potable water or contaminants to be discharged or drawn into a potable water source or other components of the potable water supply.
- (b) Open loop geothermal systems intended to circulate groundwater within a potable water supply may be connected to a potable water source provided the following requirements are met:
 - (1) No additive is added to the re-circulated groundwater.
 - (2) The heat exchange medium in the system is R-410A or a different heat exchange medium approved by the Secretary.
 - (3) The system has a low-pressure safety cutout circuit that will turn off the system when there is a pressure leak in the heat exchange medium containment vessel.
 - (4) All electrical components of the system are properly grounded to prevent potential electrolysis of metals.
 - (5) In the event that the heat exchange unit is disconnected as a heating or cooling source, all piping associated with the unit shall either be capped and labeled or removed.
 - (6) Neither steam condensate nor cooling water from engine jackets or other heat exchange devices shall be returned to a potable water supply.
- (c) Water loading stations that are designed to fill potable water vessels, containers, or vehicles with water from a potable water supply shall meet the following requirements:
 - (1) There shall be an air gap device between the potable water supply and water vessels being filled to prevent back flow into the supply.
 - (2) Hose inlets and outlets used at the station shall not come in contact with the ground, hands, or other sources of contamination.
 - (3) The hose bibb for the water loading station shall be equipped with a vacuum breaker or backflow preventer.
- (d) Drains from pits containing air relief and blow off valves shall not connect directly to sanitary sewer service or sanitary sewer collection lines nor shall they discharge at a point that will permit possible back-siphonage.

§ 1-1113 Water Quality

- (a) When a permit authorizes the construction of a groundwater potable water source, the physical modification of an existing groundwater potable water source, or an action that increases the design flow of, or modifies other operational requirements of, a groundwater potable water source, the potable water source shall be sampled for the following substances, and any water treatment system required pursuant to Subsection (d) installed, prior to any water use authorized in the permit:
 - (1) each primary and secondary contaminant listed in Tables 11-5 and 11-6; and
 - (2) any substance with a groundwater enforcement standard in the Groundwater Protection Rule and Strategy that the Secretary determines may be present in the source.

- (b) Water sampling required pursuant to Subsection (a) in association with the construction of a groundwater potable water source shall be conducted a minimum of 2 days following flushing the permitted water source for a duration sufficient to:
 - (1) remove all chlorine odor from the water supply; and
 - (2) ensure all additives, source development fluids, native silts and clays, drilling mud, and finer fraction of the gravel pack or rock fracture in the casing or bore hole are removed, to the extent practicable, and at least achieving no visible evidence of the materials, prior to sampling the potable water supply.

- (c) Water sampling required pursuant to Subsection (a) shall comply with the following requirements:
 - (1) Water samples shall be taken by the person who owns the lot on which is located the building or structure or campground that is served by the potable water supply, a well driller, a designer, a hydrogeologist, a certified water specialist, a Town health officer, a master plumber, a public water system certified operator, a Vermont State employee responsible for taking water samples prior to licensing a facility or activity, or another person deemed qualified by the Secretary.
 - (2) Water samples shall be collected from the cold water tap for a sink or, if the sink is preceded by a water treatment system, at a cold water tap before the treatment system. Water samples taken for lead shall be first draw.
 - (3) Water samples shall be submitted to the Vermont Department of Health Laboratory or a certified laboratory for analysis.
 - (4) The results of the analysis shall be submitted to the Vermont Department of Health and, when required pursuant to the permit, submitted to the Secretary. Submission of results by a certified laboratory to the respective Agency satisfies this requirement.

- (d) If the results of water sampling conducted at any time on a proposed, existing, or permitted groundwater potable water source, except those serving only one single-family residence, identify the presence of a primary contaminant at a concentration that exceeds the standard for the contaminant identified in Table 11-5 or identify the presence of a substance at a level exceeding the groundwater enforcement standards in the Groundwater Protection Rule and Strategy:
 - (1) The potable water supply may be re-tested and determined not to require water treatment pursuant to the following process:

- (A) Protocol prepared by a designer for re-testing the potable water source shall be submitted to the Secretary.
 - (B) The potable water source shall be retested pursuant to a Secretary approved protocol and information shall be provided to the Secretary that is sufficient for the Secretary to reach a determination under Subsection (d)(1)(C).
 - (C) Water treatment shall not be required if the Secretary determines that the concentration of the contaminant has lasted for only a brief period of time, the cause of the exceedance has been determined to be an unusual and non-recurring event, and the contaminant is unlikely to exist in the potable water source at a concentration that exceeds the standard.
- (2) Except where the Secretary has reached a determination pursuant to Subsection (d)(1) that no water treatment is necessary, the person who owns the lot on which is located the building or structure or campground that is served by the potable water supply shall:
- (A) obtain a permit or permit amendment for the installation of, unless subject to a permit exemption in § 1-304, a water treatment system that eliminates or reduces the concentration of the contaminant in the potable water source to below the standard; or
 - (B) obtain a permit or permit amendment for a new potable water source.

Note: The presence of a primary contaminant in a potable water supply at a concentration that exceeds the standard for the contaminant identified in Table 11-5, or the presence of a substance at a level exceeding the groundwater enforcement standards in the Groundwater Protection Rule and Strategy, is a health concern for those drinking or otherwise consuming the water. While the Secretary does not require a landowner with a groundwater potable water source serving only one single-family residence to install a water treatment system or to seek a new potable water source when contamination is identified, the Secretary recommends the landowner do so.

- (e) A failed supply for which a water treatment system is installed that eliminates or reduces the concentration of a contaminant in the potable water source to below the associated standard remains a failed supply.

**Table 11-5
Primary Contaminant Standards for Potable Water Supplies**

Primary Contaminants	Standards
Arsenic	0.010 mg/L
Escherichia coli (E.coli)	0 (absent or less than 1)
Fluoride	4 mg/L
Lead	0.015 mg/L
Manganese	0.3 mg/L
Nitrate as N	10 mg/L
Nitrite as N	1.0 mg/L

Primary Contaminants	Standards
Total Coliform Bacteria	0 (absent or less than 1)
Uranium	20 ug/L
Adjusted Gross Alpha Particle Activity (including radium 226/228 but excluding radon and uranium)	15 pCi/L

Note: The Vermont Department of Health also adopts health advisories for substances that may be found in drinking water and may be below the standards identified in Table 11-5. Additionally, the Vermont Department of Health provides recommendations for testing drinking water. Contact the Vermont Department of Health for additional information on testing and treatment options.

**Table 11-6
Secondary Contaminant Standards for Potable Water Supplies**

Secondary Contaminants	Standards
Chloride	250 mg/L
Sodium	250 mg/L
Iron	0.3 mg/L
pH	6.5 to 8.5

- (f) All surface water potable water sources shall have water treatment systems that comply with the following requirements:
- (1) The treatment components shall achieve the following standards:
 - (A) reduction of turbidity of the raw water to a level compatible with the prescribed treatment;
 - (B) 99.99 percent (4-Log) removal/inactivation of viruses;
 - (C) 99.9 percent (3-Log) removal/inactivation of *Giardia lamblia*; and
 - (D) 99.9 percent (3-Log) removal/inactivation of *Cryptosporidium*.
 - (2) The sizing of treatment components shall be based on the rate of flow through each treatment component.
 - (3) Filtration shall be completed prior to disinfection by:
 - (A) slow sand filtration;
 - (B) cartridge filter that received NSF certification for the intended level of water treatment;
 - (C) a product certified to meet standards established by the NSF/ANSI 60 and 61; or
 - (D) a product certified by one of the following organizations:
 - (i) the Water Quality Association (WQA);
 - (ii) the International Association of Plumbing and Mechanical Officials (IAPMO); or
 - (iii) an organization certified accreditation by ANSI.

- (4) Disinfection shall be completed to achieve the standards identified in Subsection (a)(1) by:
 - (A) chlorination with a contact time calculated by using the pH; and temperature of the surface water source during the coldest anticipated water temperature; or
 - (B) ultraviolet light (UV) treatment which:
 - (i) is capable of treating for adenovirus;
 - (ii) includes a solenoid valve to prohibit the flow of water when the UV light is not properly functioning; and
 - (iii) includes an audio alarm system that sounds when the UV unit is not properly functioning (e.g., dosage, lamp-out, lamp age, etc.).
- (5) If the water intake is less than 20 feet below the mean water level of the surface water, there shall also be treatment to reduce turbidity and remove cyanobacteria.
- (6) An operational and maintenance manual shall be prepared for the water treatment system that includes:
 - (A) how to maintain the water intake to remove zebra mussels or other species that may grow or reside in the pipe and affect flow rate; and
 - (B) how to maintain the water treatment system components.

Note: When proposing UV disinfection, an applicant's designer may consider a secondary disinfectant to provide a residual in the water distribution system.

§ 1-1114 Flowing Artesian Well

- (a) The Secretary may require an applicant with a known or expected flowing artesian well in bedrock or a confined surficial aquifer to use source construction methods that reduce or stop the overflow of water onto the land surface and that prevent erosion of the aquifer's confining materials.
- (b) In making the determination in Subsection (a), the Secretary shall consider:
 - (1) the cost of the required action;
 - (2) the safety of the required action; and
 - (3) whether:
 - (A) the overflow water poses an undue adverse impact on the environment, including undue erosion of the confining layers of the aquifer; or
 - (B) the overflow water may interfere with any potable water source or public water source.
- (c) Known or expected flowing artesian wells shall have an overflow pipe from the source that:
 - (1) directs the overflow water from the source away from any soil-based wastewater system;
 - (2) does not discharge to a wastewater system;
 - (3) prevents the surface discharge of overflow water to land not owned by the applicant unless the applicant has permanent legal access that allows such discharge;
 - (4) discharges the overflow water a minimum of 6 inches above the ground surface to allow water to passively drain away from the well and to prevent the flow of

- water through the overflow pipe back into the source;
- (5) discharges above a splash plate or pad; and
- (6) has a 24 mesh non-corrodible screen covering the outlet.

Note: The overflow water from artesian wells may be subject to other Agency rules and permitting requirements.

§ 1-1115 Closure of Potable Water Sources

- (a) Potable water sources that are no longer serving a building or structure or campground are recommended to be closed and may be required by the Secretary to be closed to prevent possible contamination of the aquifer or to otherwise protect human health and the environment.
- (b) Potable water sources that are failed supplies are recommended to be closed and may be required by the Secretary to be closed to prevent possible contamination of the aquifer or to otherwise protect human health and the environment.
- (c) Closure of a groundwater potable water source that is equal to or greater than 20 feet deep shall be performed by a well driller.
- (d) Closure of a groundwater potable water source shall be completed by taking the following steps:
 - (1) Clearing the potable water source of any pumps, wires, and piping.
 - (2) Removing the cover and all other materials that will interfere with effective closing.
 - (3) Sealing the potable water source to prevent exchange of water from one aquifer to another or out of the casing.
 - (4) For a potable water source that is equal to or greater than 20 feet deep, completely filling the casing and bore hole with the following grouting materials:
 - (A) For potable water sources located at solid waste disposal facilities, hazardous waste facilities, or contaminated sites, bentonite or Portland Type I or III Cement.
 - (B) For potable water sources at all other locations, acceptable sealing materials based on site specific conditions, such as:
 - (i) cement grout;
 - (ii) bentonite grout slurry (15 percent solids by volume);
 - (iii) bentonite chips;
 - (iv) a sealing material or other material to render the bore hole as impeding as the surrounding native material; or
 - (v) alternating 50-foot layers of clean stone, pea stone, or sand and 10-foot sections of bentonite with the last 10-foot layer to just below ground surface filled with neat cement.
 - (5) For a potable water source that is less than 20 feet deep, completely filling the well tile with soil or other material to ground surface.
 - (6) Cutting or removing the casing so that the remaining casing terminates below finished ground surface.
- (e) Closure of a surface water potable water source shall be completed by taking the

following steps:

- (1) Removing the water intake pipe and associated infrastructure from the source.
- (2) Cutting and capping the pipe located in the source, or sealing it using other methods approved by the Secretary, at a point above the normal high-water elevation.

Subchapter 12 – Flexible Specific Technical Standards for Potable Water Supplies

§ 1-1201 Request for Alternative Technical Standard

- (a) The Secretary may accept, in an application for a permit or permit amendment, the use of an alternative technical standard to a technical standard included in this Subchapter when the Secretary concludes that the alternative technical standard:
 - (1) will meet the purpose served by the technical standard in this Subchapter;
 - (2) has been adopted and published by one of the following organizations:
 - (A) American Association of the State Highway and Transportation Officials (AASHTO);
 - (B) National Sanitation Foundation (NSF);
 - (C) American National Standards Institute, Inc. (ANSI);
 - (D) American Society of Civil Engineers (ASCE);
 - (E) American Public Works Association (APWA);
 - (F) American Society for Testing and Materials (ASTM);
 - (G) American Water Works Association (AWWA);
 - (H) Cast Iron Soil Pipe Institute (CISPI);
 - (I) New England Interstate Water Pollution Control Commission (NEIWPCC);
 - (J) 10 States Standards – Recommended Standards for Water Works;
 - (K) National Groundwater Association (NGWA);
 - (3) incorporates more current technology than included in the technical standard in this Subchapter;
 - (4) will not adversely affect the maintainability, operation, or safety of the potable water supply; and
 - (5) where specified, meets any additional criteria required by these Rules for a Secretary approved alternative technical standard.

- (b) An application that seeks to use an alternative technical standard shall include a written request that includes:
 - (1) the specific technical standard in this Subchapter for which approval of an alternative technical standard is sought; and
 - (2) supporting documentation demonstrating each of the findings included in Subsection (a).

§ 1-1202 General Requirements for Water Service Lines and Water Service Pipes

- (a) Water service lines and water service pipes shall be sized based on a hydraulic analysis that considers flow demands and pressure requirements, using the standards in the Vermont Plumbing Rules.

- (b) Water service lines and water service pipes shall be constructed of one of the following materials:
 - (1) Type K copper tubing complying with standard ASTM B-88;
 - (2) materials that comply with the standards in the Vermont Plumbing Rules; or
 - (3) other materials approved by the Secretary when it is demonstrated that the pipe material equals or exceeds the requirements in the Plumbing Rules.

- (c) Water service lines and water service pipes shall:
 - (1) have watertight joints;
 - (2) have a working pressure rating of not less than 160 psi;
 - (3) be designed to minimize friction loss; and
 - (4) be protected against surge or water hammer.
- (d) Water service lines shall not connect to hydrant lead lines.
- (e) Connections of a water service line to a water main shall include a water shutoff or curb stop that allows the flow of water from the water main to the water service line to be stopped during repairs.
- (f) Packing and jointing materials used in the joints of pipes shall meet the standards of the Vermont Plumbing Rules.
- (g) Valves, blow-offs, meters, air relief valves, or other such appurtenances on water service lines or pipes shall not be located in chambers, pits, or manholes, unless the chamber, pit, or manhole has a discharge pipe that terminates at least 18 inches above ground surface, shall passively drain water from the enclosure, and shall remain visible.
- (h) Thrust blocks or restrained mechanical joints shall be used at tees or bends of water service pipes and water service lines if necessary to prevent pipe movement.
- (i) Water service lines and water service pipes shall not pass through sewer manholes or be submerged in a basin containing wastewater, contaminated material, or hazardous material.
- (j) Water service lines and water service pipes shall be covered with at least 5.5 feet of soil or be insulated and covered in a manner that provides an equivalent degree of protection from freezing and damage that 5.5 feet of soil would provide.

§ 1-1203 Design Standards for Water Service Lines and Water Service Pipes Under and Over Surface Water

- (a) Water service lines and water service pipes crossing under surface water shall:
 - (1) include flexible watertight joints; and
 - (2) except for water service pipes of a potable water supply with a surface water source:
 - (A) maintain a minimum of 5 feet of soil cover over the water service line or water service pipe, as measured from the lowest point of the surface water bed;
 - (B) have accessible valves at both ends of the underwater crossing so the section may be isolated; and
 - (C) be placed in a watertight sleeve that extends the full length of the underwater crossing.
- (b) Water service lines and water service pipes crossing aerially over surface water shall:
 - (1) be adequately supported and anchored;

- (2) be protected from damage from flood waters, floating debris, ice, and freezing;
 - (3) have accessible valves that are placed in naturally occurring soil at both ends of the lake, pond, or stream crossing so the section exposed to atmosphere may be isolated; and
 - (4) be accessible for repair or replacement.
- (c) A water service pipe that is a surface water intake shall:
- (1) be a minimum of 20 feet below the low water elevation of the surface water unless the water treatment system complies with § 1-1113(f);
 - (2) meet one of the following:
 - (A) terminate the intake of the water service pipe a minimum of 2 feet above the bottom of the surface water; or
 - (B) terminate the intake of the water service pipe in a sand infiltrative gallery installed below the bottom of the surface water source with a minimum of 2 feet of sand fill over the water intake;
 - (3) be sufficiently anchored to prevent movement of the pipe;
 - (4) be protected from freezing;
 - (5) not impact a wetland; and
 - (6) not be located in a Waste Management Zone as determined by the Watershed Management Division for the discharge from a municipal treatment facility.

§ 1-1204 Separation of Water Service Lines and Water Service Pipes from Sanitary Sewer Service Lines, Sanitary Sewer Collection Lines, and Storm Sewers

- (a) Horizontal Isolation Distances from Sanitary Sewer Collection Lines, Sanitary Sewer Service Lines, and Storm Sewers
- (1) All portions of a water service line and water service pipe shall be at least 10 feet horizontally from all portions of the proposed, existing, or permitted sanitary sewer collection lines and sanitary sewer service lines, including sewer manholes, except when the water service line or water service pipe is:
 - (A) sleeved with pipe materials approved by the Vermont Plumbing Rules and
 - (i) if the sleeves terminate below ground, the ends of the sleeve are sealed to be watertight; or
 - (ii) if the sleeves terminate above finished slab or in a basement, the ends of the sleeve are sealed to be watertight or left open; or
 - (B) in a separate trench or an undisturbed soil shelf in the sewer trench and one of the following requirements is met:
 - (i) the bottom of the water service line or water service pipe shall be at least 18 inches above the top of the sanitary sewer collection line or sanitary sewer service line; or
 - (ii) the sanitary sewer collection line or sanitary sewer service line shall be water main pipe or equivalent and, to ensure water tightness:
 - (I) shall be pressure tested at 50 pounds per square inch; or
 - (II) all joints not meeting the 10 feet horizontal separation are to be further improved to prevent leakage using mechanically jointed non-flexible pipe couplings, concrete

encasement, or other equivalent methods as approved by the Secretary.

- (2) All portions of water service lines and water service pipes shall be laid at least 5 horizontal feet from all portions of a proposed, existing, or permitted storm sewer.

(b) Vertical Separation and Crossings for Sanitary Sewer Collection Lines, Sanitary Sewer Service Lines, and Storm Sewers

- (1) Water service lines and water service pipes crossing above proposed, existing, or permitted sanitary sewer collection lines or sanitary sewer service lines shall meet one of the following requirements:

- (A) The bottom of the water service lines and water service pipes shall be laid 18 inches above the top of the sanitary sewer collection line or sanitary sewer service line.

- (B) The water service lines and water service pipes shall be sleeved with pipe materials approved by the Vermont Plumbing Rules to a point 10-horizontal feet from the sanitary sewer collection line or sanitary sewer service line and:

- (i) if the sleeves terminate below ground surface, have the ends of the sleeve sealed to be watertight; or

- (ii) if the sleeves terminate above finished slab or in a basement, have the ends of the sleeve sealed to be watertight or left open.

- (C) The water service lines and water service pipes shall be centered at the crossing, so the water joints will be as far as possible from the sanitary sewer joints and one of the following requirements shall be met:

- (i) The water service lines and water service pipes shall be laid to provide a minimum vertical distance of 18 inches between the bottom of the water service line or water service pipe and the top of the sanitary sewer collection line or sanitary sewer service line.

- (ii) The sanitary sewer collection lines and sanitary sewer service lines shall be water main pipe or equivalent and, to ensure water tightness:

- (I) shall be pressure tested at 50 pounds per square inch; or

- (II) all joints not meeting the 10 feet horizontal separation are to be further improved to prevent leakage using mechanically jointed non-flexible pipe couplings, concrete encasement, or other equivalent methods as approved by the Secretary.

- (2) Water service lines and water service pipes crossing below proposed, existing, or permitted sanitary sewer collection lines or sanitary sewer service lines shall meet one of the following requirements:

- (A) The water service line or water service pipe shall be sleeved with pipe materials approved by the Vermont Plumbing Rules to a point 10-horizontal feet from the sanitary sewer collection line or sanitary sewer service line and:

- (i) if the sleeves terminate below ground surface, have the ends of the sleeve sealed to be watertight; or

- (ii) if the sleeves terminate above finished slab or in a basement, have the ends of the sleeve sealed to be watertight or left open.

- (B) The water service line or water service pipe meets the following requirements:
 - (i) The top of the water service lines and water service pipes shall be laid 18 inches below the bottom of the sanitary sewer collection line or sanitary sewer service line.
 - (ii) Water service lines and water service pipes shall be centered at the crossing, so the joints in the water line or water pipe will be a minimum of 10 feet from the center line of the crossing.
- (3) Water service lines and water service pipes crossing above or below proposed, existing, or permitted storm sewers shall meet the following requirements:
 - (A) If the water service line or water service pipe is crossing above, the water service lines and water service pipes shall be laid to provide a minimum vertical distance of 18 inches between the bottom of the water service line or water service pipe and the top of the storm drain.
 - (B) If the water service line or water service pipe is crossing below, the water service lines and water service pipes shall be laid to provide a minimum vertical distance of 18 inches between the top of the water service line or water service pipe and the bottom of the storm drain.
 - (C) Water service lines and water service pipes crossing less than 18 inches over a storm drain shall be centered at the crossing so the joints in the line or pipe will be as far as possible from the storm sewer joints.
 - (D) Water service lines and water service pipes crossing less than 18 inches under a storm sewer, the lines or pipes shall have the joints in the line or pipe a minimum of 10 feet from the center line of the storm drain.

§ 1-1205 Potable Water Source Design and Construction

- (a) Design and construction of potable water sources shall:
 - (1) prevent damage to the casing;
 - (2) extend casings a minimum of 18 inches above finished grade except as allowed in Subsection (f);
 - (3) ensure all fluids, muds, and additives have the approval of an ANSI accredited organization;
 - (4) ensure process water for drilling a source, or injection water for hydrofracturing a water source, is obtained from a potable water source or public water source; however, if such water is unavailable in sufficient quantity, ensure clear, non-potable water that is obtained from a surface water body and is disinfected with an initial dosage of at least 100 mg/L of chlorine prior to using it as the process water;
 - (5) ensure that any casing, tools, or drilling fluids that may be contaminated shall not be used or reused when constructing or repairing a source; and
 - (6) include a cap or other protective cover that is:
 - (A) permanent and tight fitting that cannot be removed or opened without the use of tools or keys;
 - (B) water-tight designed to shed water and snow;
 - (C) an overlapping, shoebox-type cover or hatch that is permanently attached to the source structure, or protective structure; and
 - (D) animal and insect proof.

- (b) Requirements for Casing Material
- (1) Well casing shall be made of material that will not distort, collapse, crack, or disintegrate during placement or under normal conditions.
 - (2) Well casing shall be sized and designed to provide for the installation, removal, and maintenance as appropriate for caps, covers, pitless adapters, screens, pumps, pipes, wires, or other devices.
 - (3) Well casing extensions shall be of the same material that is, at a minimum, of equal strength and weight as the existing casing.
 - (A) For steel casing extensions, the extension shall be joined to the original casing by:
 - (i) threaded steel coupling;
 - (ii) welded pipe joint;
 - (iii) weld to threaded steel slip coupling; or
 - (iv) mechanical steel bolted restraining coupling, also known as Dresser coupling.
 - (B) For plastic casing extensions, the extension shall be joined to the original casing by:
 - (i) solvent welds; or
 - (ii) threaded couplings.
 - (4) When steel pipe is used for permanent casing, the steel pipe shall be a new pipe meeting the minimum of AWWA, ASTM, or API specifications for water well construction and:
 - (A) be Schedule 30 or greater; or
 - (B) meet all of the following requirements:
 - (i) have a minimum $\frac{1}{4}$ inch wall thickness for 7-inch casing;
 - (ii) be equipped with a drive shoe or equivalent when driven into bedrock; and
 - (iii) have full circumferential welds or threaded coupling joints.
 - (5) When nonferrous materials are used for permanent casing, the nonferrous materials shall be:
 - (A) resistant to the corrosivity of the water and to the stresses that it will be subjected to during installation, grouting, and operation;
 - (B) PVC pipe, when used as permanent casing, that is Schedule 80, SDR 21, or heavier new pipe that complies with ASTM specification F 480 and NSF or UL standards; and
 - (C) concrete tiles joined with a watertight material that is ANSI or NSF approved.
 - (6) Liners set within the uncased bore hole shall:
 - (A) terminate with a packer or otherwise be secured to the bore hole;
 - (B) be slotted, screened, or perforated to permit the movement or storage of water; and
 - (C) when the liner is set to control water movement or contamination, be grouted and watertight.
 - (7) Packers or well seals placed within the casing or bore hole to prevent the migration of water shall be of material that will not impart taste, odor, toxic substance or bacterial contamination to the source water.

- (c) Liner material, when used in a potable water source, shall be of such strength and composition to prevent the movement of water or contaminants into or out of the potable water source in the interval cased.
- (d) Potable water sources located in a flood hazard area shall:
 - (1) if the top of the casing is below the base flood elevation, have a watertight cap or cover (a sanitary seal shall not be used);
 - (2) have the top of the well casing terminate at least 18 inches above finished grade;
 - (3) have source vents terminate above the base flood elevation;
 - (4) be located, designed, and constructed in a manner that avoids impairment to the supply and contamination to the system during flooding. (Refer to the following guidance from the Department of Homeland Security, Federal Emergency Management Agency FEMA P-348: Protecting Building Utility Systems from Flood Damage); and
 - (5) have other suitable protection as required by the Secretary to prevent surface or storm water entering the casing.
- (e) Potable water sources shall only be located in a structure when:
 - (1) the floor of the structure terminates a minimum of 12 inches above finished ground surface;
 - (2) if the structure is located in a flood hazard area, the floor of the structure terminates at or above the base flood elevation;
 - (3) the source casing extends a minimum of 12 inches above finished floor elevation;
 - (4) water runoff from the structure floor, roof, and exterior passively drains away from the structure,
 - (5) the structure is sealed and screened to exclude birds and animals, and is capable of being locked; and
 - (6) the design of the structure allows for removal of the pump.
- (f) Potable water sources shall not be located in an underground enclosure unless approved by the Secretary. When location of a potable water source in an underground enclosure is authorized by the Secretary:
 - (1) the enclosure shall be watertight with a watertight access cover;
 - (2) the enclosure shall have a cap or protective cover that terminates 18 inches above finished floor;
 - (3) construction of the source shall comply with the standards in Subsection (d) when the source is located in flood hazard areas;
 - (4) the floor of the enclosure shall be made of concrete and shall be sealed to the casing;
 - (5) the enclosure shall have all penetrations standard wall castings that are:
 - (A) poured in place during the forming of the concrete; or
 - (B) wall sleeves with flexible wall penetrations for concrete tanks joined to the underground enclosure with watertight connections;
 - (6) the enclosure shall have a minimum of one floor drain within the floor of the enclosure that has a backwater valve on the drain/discharge pipe that complies with the Vermont Plumbing Rules. The discharge pipe shall terminate at least 18 inches above ground surface, shall passively drain away from the enclosure, and shall remain visible;

- (7) the wiring for the pump shall be sealed for watertightness where it enters the cap or be contained in a watertight conduit system;
 - (8) the potable water source and underground enclosure shall be vented to the atmosphere independent of each other, and all vents shall terminate above the base flood elevation;
 - (9) the enclosure shall be sealed and screened to exclude birds and animals; and
 - (10) the enclosure shall be capable of being locked.
- (g) Requirements for Venting
- (1) Venting of the potable water source casing and of an enclosure in which a potable water source is located shall:
 - (A) be to atmosphere;
 - (B) be of adequate size to provide rapid venting of the casing and be corrosion resistant; and
 - (C) terminate in a downturned position.
 - (2) Flowing artesian wells are not required to have a vent at the source.
- (h) Caps, covers, vents, drains, and overflow pipes shall be covered or inserted with a 24 mesh non-corrodible screen.
- (i) One of the following drilling methods shall be used to drill a potable water source:
- (1) air rotary;
 - (2) cable tool (driven);
 - (3) mud rotary;
 - (4) reverse circulation;
 - (5) eccentric and concentric;
 - (6) dual rotary;
 - (7) drill and drive; and
 - (8) other methods allowed by the Secretary.
- (j) Grouting shall be designed to allow negligible movement of all fluids in the annular space around well casings and provide negligible shrinkage, breakage, or deterioration of the grout after placement. One of the following grout types and specifications shall be used:
- (1) neat cement grout:
 - (A) consisting of a mixture of API Sec. 10, ASTM C150 type 1 or ASTM C150 type 2, with a maximum of 6 gallons of water per 94-pound sack of cement for 1½ inch or larger annular openings; and
 - (B) containing additives approved by the Secretary when proposed to increase fluidity;
 - (2) concrete grout:
 - (A) consisting of equal parts of ASTM C150, type 1 or 2 Portland cement, and sand, with a maximum of 5 gallons of water per 94-pound sack of cement for annular openings larger than 1½ inches; and
 - (B) where an annular opening is larger than 4 inches, gravel not larger than ½ inch in size may be added;
 - (3) bentonite grout that has standard ANSI 60 certification and is installed according to manufacturers' directions;

- (4) clay seal/bentonite grout consisting of clay mixed with at least 10 percent swelling bentonite may be used when there is an annular opening greater than 6 inches and approved by the Secretary prior to grout application;
- (5) bentonite chips, slurry, or powder shall be placed continuously around the casing during advancement with each of the following drilling methods when no pilot hole is drilled larger than the drill hole for the casing:
 - (A) concentric drilling;
 - (B) dual rotary;
 - (C) drill and drive; or
 - (D) eccentric; or
- (6) other types of grout approved by the Secretary.

§ 1-1206 Potable Water Sources in Bedrock, Confined Surficial Aquifers, and Unconfined Surficial Aquifers

- (a) Potable water sources in bedrock shall be constructed with a minimum of:
 - (1) 20 feet of watertight casing; and
 - (2) a minimum of 10 feet of casing set into competent bedrock.
- (b) Drilled wells, driven wells, or well points in unconfined surficial aquifers and confined surficial aquifers shall:
 - (1) Provide a bentonite seal between the casing and ground surface if the source is not required to be grouted.
 - (2) Have gravel pack that is rounded particles, 95 percent siliceous material; that is smooth and uniform, free of foreign material, properly sized, washed and then disinfected immediately prior to or during placement.
 - (3) Have the gravel pack placed in one uniform continuous operation.
 - (4) Have screens that:
 - (A) are made of materials capable of withstanding the imposed structural loads;
 - (B) are resistant to damage by chemical action of groundwater or cleaning operations;
 - (C) have openings sized based on the sieve analysis of the formation or gravel pack materials;
 - (D) have sufficient diameter to provide adequate specific capacity and low aperture entrance velocity. The entrance velocity should not exceed 0.1 feet per second.
 - (E) allow the pumping water elevation to remain above the screen under all operating conditions;
 - (F) when applicable, be designed and installed to permit removal or replacement without adversely affecting watertight construction of the well; and
 - (G) have a bottom plate or wash-down bottom fitting of the same material as the screen.
 - (5) Provide protection from leakage of grout or fine-grained formation materials into the gravel pack or screen.

Note: Appendix C, Figure C-16, depicts a detail of a typical drilled bedrock well and Appendix

C, Figure C-17, depicts a detail of a typical driven well.

- (c) Wells using tiles in unconfined surficial aquifers and confined surficial aquifers shall have:
 - (1) All joints between concrete tiles and pipe penetrations be watertight using sealant or grout specifically designed for drinking water systems. All sealant or grout used shall be approved by an ANSI accredited organization.
 - (2) Bedding that is clean ½ inch washed stone.
 - (3) A diversion berm or swale constructed up-gradient from the source to divert runoff and stormwater away from the source.
 - (4) Backfill from ground surface to the bedding stone of clean native fill or finer textured soil.
 - (5) Backfill material of high clay content or equal surrounding the well tile and sloping away from the source for a distance of 10 feet to prevent stormwater from ponding around the well or well gallery.
 - (6) A minimum of 4 inches of topsoil over the clay.
 - (7) For sources that are pumped:
 - (A) dry run protection or a low water shut-off; and
 - (B) pumps set above the bottom of the source.
 - (8) Not be required to have overflow openings. Design of an overflow, when proposed, shall comply with § 1-1114(c).

Note: Appendix C, Figure C-18, depicts a detail of a typical dug well or spring.

§ 1-1207 Pipes and Pumps

- (a) Pipes and fittings that are part of a potable water supply shall meet ANSI standards for potable water.
- (b) Pumps shall meet the following requirements:
 - (1) Pumps shall have a standard pressure gauge in the discharge line for each pump prior to a hydropneumatic tank or other water storage tank.
 - (2) Pumps shall be designed to alternate when 2 or more pumps are installed.
 - (3) Pumps shall have a check valve within the casing at an elevation below the calculated drawdown level to prevent backflow for pumps installed in the well and to allow for operation, maintenance, repair, and replacement of the equipment.
 - (4) If a design includes multiple pumps, each shall have positive-acting check valve on the discharge side between the pump and the shut-off valve.
 - (5) If a design includes a foot valve, the foot valve shall have a net valve area of at least 1.5 times the area of the suction pipe and be screened.
- (c) Suction lift pumps shall also:
 - (1) be no more than 15 feet above the static water elevation in the source; and
 - (2) include measures for priming the pump including:
 - (A) using prime water that is at least the same quality as the water being pumped; and
 - (B) provisions to prevent back siphonage.

- (d) Potable water sources with submersible pumps shall have:
 - (1) the electrical cable firmly attached to the riser pipe at 20-foot intervals or less;
 - (2) torque arresters if needed; and
 - (3) other appropriate means to properly support and prevent excessive movement of the pumping system or damage to the source.
- (e) Wiring inside the potable water source casing shall comply with the Vermont Electrical Safety Rules.
- (f) Wiring outside of the potable source casing shall:
 - (1) be in a conduit or pipe from the well cap to at least 2 feet below land surface;
 - (2) include a frost sleeve if piped with electrical conduit; and
 - (3) comply with other requirements in the Vermont Electrical Safety Rules.

§ 1-1208 Requirements for Water Storage Tanks

- (a) The bottom of a water storage tank shall be 2 feet above the seasonal high-water table unless the structure is provided proper anchors to prevent movement of the structure. If the structure is plastic or fiberglass, it shall comply with the manufacturers specifications for location within a seasonal high-water table.
- (b) Water storage tanks shall be structurally capable of withstanding all external and internal forces exerted on the tank and shall be constructed of one of the following materials:
 - (1) steel that complies with ASTM standards for steel tanks, reservoirs, and elevated tanks;
 - (2) cast-in place and pre-cast concrete that is reinforced; or
 - (3) a material approved by the Secretary, including types of plastic and fiberglass, that:
 - (A) will not decay by ultraviolet light or other causes; and
 - (B) will protect the quality of the stored water.
- (c) Water storage tanks shall:
 - (1) Be designed to prevent freezing.
 - (2) Be designed so that the top of the water storage tank is a minimum of 24 inches above the ground surface.
 - (3) Have a watertight access hatch that is elevated at least 18 inches above the top of the structure.
 - (4) Have a solid watertight cover that overlaps the hatch frame opening that extends down around the frame at least 2 inches.
 - (5) Have a drain to passively empty the tank for cleaning or maintenance.
 - (6) Have an overflow of sufficient diameter to permit discharge of water in excess of the filling rate.
 - (7) Have the drain and overflow discharge pipe:
 - (A) open downward a minimum of 18 inches above a splash plate when discharging to ground surface; or
 - (B) have an air-gap between the pipe and a sanitary sewer collection line, sanitary sewer service line, or storm drain when discharging to a line or

- drain.
- (8) The overflow discharge pipe shall have a 24 mesh non-corrodible screen covering the outlet.
 - (d) Venting shall be provided on all water storage tanks and the venting shall:
 - (1) prevent the entrance of stormwater and precipitation;
 - (2) open downward;
 - (3) terminate 24 inches above finished ground surface; and
 - (4) have a 24 mesh non-corrodible screen covering the vent outlet.
 - (e) Water storage overflow pipes shall not be used as vents.
 - (f) Roofs and sidewalls of water storage tanks shall meet the following requirements:
 - (1) Roofs and sidewalls shall have watertight construction with no openings except properly constructed means of access, vents, manholes, overflows, risers, drains, pump mountings, control ports, and piping for inflow and outflow. Open construction between the sidewall and roof of the structure is not permissible.
 - (2) Pipes extending through the roof or sidewall of a finished water storage tank shall:
 - (A) for metal tanks, have welded or properly gasketed sleeves; or
 - (B) for concrete tanks:
 - (i) be connected to standard wall castings that were poured-in-place during the forming of the concrete. The wall castings shall have seepage rings embedded in the concrete for water stoppage on sleeves (castings) in exterior or water-bearing walls; or
 - (ii) have interconnected synthetic rubber links shaped and sized to continuously fill the annular space between the pipe and wall sleeve opening.
 - (3) Openings in the roof or top of the water storage tank that accommodate control apparatus or pump columns shall be curbed and sleeved with proper additional shielding to prevent the access of surface or drainage water into the structure.
 - (4) Roofs shall be sloped to facilitate draining.
 - (5) Valves and controls located outside the water storage tank shall not have valve systems and similar projections pass through the roof or top of the storage structure.
 - (6) Materials that will be exposed to the potable water are required to meet the NSF International/American National Standard Institute (NSF/ANSI) Standard 61.
 - (g) Painting or cathodic protection shall be applied to metal surfaces of water storage tanks.
 - (1) Paints or coatings used in the interior of water storage tanks shall be approved for use in drinking water systems by ANSI accredited organizations.
 - (2) Samples of the water in a water storage tank shall be analyzed for volatile organic compounds prior to putting the water storage tank into service to establish that the paint or coating properly cured and will not contaminate water held in the structure.
 - (h) Grading around a ground level water storage tank shall be done in a manner to prevent stormwater from standing within 50 feet of the structure.

§ 1-1209 Leakage and Pressure Testing

- (a) Water service lines and water service pipes shall be pressure tested and leakage tested according to one of the following procedures prior to placing the potable water supply into service:
 - (1) Vermont Plumbing Rules;
 - (2) the AWWA; or
 - (3) by pressurizing the lines and pipes with water at the working pressure of the system or greater and hold without a drop in pressure for a minimum of 16 minutes.

- (b) Atmospheric storage structures shall be leakage tested according to the following procedure to ensure water loss is equal to or less than 0.05 of 1 percent of the tank capacity prior to placing the structure into service:
 - (1) filling the tank with potable water and let stand for 24 hours; and
 - (2) measuring the loss of water over 24 hours.

- (c) If the water service line, water service pipe, or atmospheric storage structure fails the pressure or leakage test, the cause of the failure shall be repaired, and the line, pipe, or structure retested.

§ 1-1210 Disinfection

- (a) A potable water supply shall be disinfected pursuant to the requirements of Subsection (b), (c), and (d) prior to placing the potable water supply into service and after any servicing or repair of the potable water supply, such as installation of new pipes, wires, casing, or pumps.

- (b) Disinfection of the potable water source shall be completed pursuant to the recommendations by the Vermont Department of Health for disinfecting a water system, or the following method:
 - (1) flush the potable water supply until the water runs clear;
 - (2) provide an initial dosage of at least 100 mg/L of chlorine in the potable water source;
 - (3) circulate the water in the potable water source; and
 - (4) allow the water to rest in the potable water source for a minimum of 12 to 24 hours before disposing of the chlorinated water.

- (c) Disinfection of water service lines and water service pipes shall be completed pursuant to the requirements of the Vermont Plumbing Rules or the following method:
 - (1) fill the water service line or water service pipe with a water/chlorine solution of 100 mg/L; and
 - (2) allow the chlorinated water to rest in the water service line or water service pipe for a minimum of 24 hours before disposing of the chlorinated water.

- (d) Disinfection of water storage tanks shall be completed pursuant to AWWA Standard C652.

- (e) Chlorinated water used to disinfect or resulting from disinfection of potable water supplies shall not be discharged to a wastewater system or to surface water. Proper disposal of the chlorinated water is to the ground surface through sheet flow that infiltrates into the soil or disposal to a wastewater treatment facility, if authorized by the wastewater treatment facility.

Appendix A – Information for an Application

- (a) For the purposes of this appendix, the term “project” means all components of all wastewater systems and potable water supplies that are required to be part of an application.
- (b) When the application includes one or more existing or proposed lots, the latitude and longitude for the center of each existing or proposed lot identified in the application shall be reported on the application form using a global positioning system receiver using the NAD 83 coordinate system or a NAD 83 base map. The coordinates shall be reported in decimal degrees to five decimal places with an accuracy of +/- 50 feet. Because many lots are irregularly shaped, the center location can be approximate.
- (c) When the application includes a wastewater system presumptive isolation zone or potable water supply presumptive isolation zone that requires notification under § 1-307(a), the application shall include:
 - (1) a copy of each certified mail receipt;
 - (2) the completed ANR Form 1 and ANR Form 4 provided by the Secretary for notification of presumptive isolation zones; and
 - (3) the site plan sent to a landowner affected by the presumptive isolation zone.
- (d) When the application includes a wastewater system presumptive isolation zone or potable water supply presumptive isolation zone that does not require notification under § 1-307(e)(1) and (2), the application shall include the completed ANR Form 5 provided by the Secretary for certification no notification is required.
- (e) When the application needs to identify proposed or existing buildings or structures or campgrounds, soil-based wastewater systems, sanitary sewer service lines, sanitary sewer collection lines, potable water supplies, or the subdivision of land, a site plan shall be included with the application that includes the following information:
 - (1) Preparer’s signature, plan title, date, and revision date(s) on all plans.
 - (2) Legend or clear identification of all plan features.
 - (3) North arrow.
 - (4) Plan scale as required by Rules stated on the plans. A graphic representation may be shown but does not replace a stated scale.
 - (A) Except as required by Subsection (c)(4)(C), site plans shall be prepared to a scale not greater than 1-inch equals 100 feet.
 - (B) Site plans shall be prepared to a scale not greater than 1-inch equals 30 feet for those site plans identifying the limits of the infiltrative area for an in-ground leachfield; the limits of the stone and fill material for an at-grade leachfield; the limits of the fill material for a mound; the enclosure for a bottomless sand filter; and the area 25 feet downslope and 10 feet on all other sides from the limits of the stone and fill material for an at-grade leachfield, the limits of the fill material for a mound, and the enclosure for a bottomless sand filter.
 - (C) Notwithstanding Subsection (c)(4)(A), a site plan may have scale greater than 1-inch equals 100 feet, including the use of aerial photographs, for the purposes of:

- (i) identifying the boundary line locations and dimensions when the size of the lot is greater than 10 acres;
 - (ii) identifying a site listed on the hazardous sites list maintained by the Waste Management Division of the Department that is located greater than 500 feet and within one third of a mile to a potable water supply; or
 - (iii) identification of surface drainage patterns.
- (5) The location and elevation of the permanent benchmark established on the lot.
- (6) All existing and proposed boundary lines and boundary line dimensions.
- (7) For the lot on which a wastewater system or a potable water supply is proposed:
 - (A) Lot numbers or unique lot designations for subdivisions involving 2 or more lots.
 - (B) Campsite numbers or unique campsite designations for campgrounds.
 - (C) Existing and proposed permanent legal accesses.
 - (D) Existing and proposed driveways, parking lots, and roadways.
 - (E) Existing and proposed buildings or structures, or campgrounds.
 - (F) Designated Well Head Protection Area (WHPA).
 - (G) Surface water such as streams, lakes, ponds, reservoirs, and other water impoundments.
 - (H) Stormwater conveyance/treatment/control practices.
 - (I) Class 1 or Class II wetlands.
 - (J) Base flood elevation.
 - (K) Floodways.
- (8) Contours shall be provided using the following specifications:
 - (A) 5-foot contour interval shall be provided for drawing isolation zones around leachfields, wastewater system components, potable water supply sources, and potable water supply components except when the component of the potable water supply is a water service line or a water service pipe, and except when the component of the wastewater system is a sanitary sewer service line connecting to a sanitary sewer collection line.
 - (B) 2-foot contour intervals shall be provided for that portion of the plan identifying the limits of the stone and fill material for an at-grade leachfield; the limits of the fill material for a mound; the enclosure for a bottomless sand filter; and the area 25 feet downslope and 10 feet on all other sides from the limits of the stone and fill material for an at-grade leachfield, the limits of the fill material for a mound, and the enclosure for a bottomless sand filter.
 - (C) At least 90 percent of the contours shall be accurate within one half contour interval and no inaccuracies shall exceed one contour interval.
 - (D) Photogrammetric contour maps may only be used to show the general contour of the land when it is necessary to show ground or groundwater flow to such items as hazardous waste sites and public water sources.
- (f) For an application proposing a wastewater system, the following additional information shall be provided:
 - (1) Required information to be shown on the site plan for a soil-based wastewater system:

- (A) Location of all components of the proposed wastewater system and replacement area.
 - (B) Location of all proposed, existing or permitted potable water sources and public water sources that are on the applicant's property.
 - (C) Location of all proposed, existing, or permitted potable water sources and public water sources that are off the applicant's property but that have an isolation zone identified in § 1-912(b) that ends 50 feet or less from the proposed leachfield.
 - (D) Location of any Zone 1 of a Public Community Water System Source Protection Area that are on the applicant's property or are off the applicant's property but within 50 feet of the applicant's nearest property line.
 - (E) Isolation zones identified in § 1-912(b) drawn around all proposed, existing, or permitted potable water sources and public water sources identified in Subsection (d)(1)(B) and (C).
 - (F) Location and identification of features and objects identified in Table 9-3 that are on the applicant's property.
 - (G) All soil test pit locations with corresponding numbers or letter designations conducted within 50 feet of a leachfield.
 - (H) Existing and proposed footing drains, curtain drains, and drainage pipes or tiles within 75 feet of a leachfield.
 - (I) Existing and proposed surface water drainage ditches, and surface water swales within 75 feet of a leachfield.
 - (J) Ledge outcrops and other site limitations that may interfere with the proper installation of the components of the wastewater system.
- (2) Required information to be shown on the site plan for a water main, water service line, or water service pipe:
- (A) Location of existing, proposed, or permitted water mains, water service lines, or water service pipes that are on the applicant's property or off the applicant's property but are within 50 feet of the applicant's nearest property line.
 - (B) Elevations and material specifications of the water main, water service line, or water service pipe when:
 - (i) a sanitary sewer collection line or sanitary sewer service line crosses a water main, water service line, or water service pipe; or
 - (ii) a sanitary sewer collection line or sanitary sewer service line is within the horizontal isolation distance to a water main, water service line, or water service pipe.
- (3) Plans with details for components of a wastewater system.
- (A) Preparer's signature, plan title, date, and revision date(s) on all plans.
 - (B) Septic tank effluent filter manufacturer and model number identified with the tank detail.
 - (C) Septic tank size, dimensions, riser to grade, and material specifications.
 - (D) Grease tank size, dimensions, and material specifications.
 - (E) Innovative/alternative system or component if the system or component has general, pilot, or experimental approval.
 - (F) Pump station including float material (mercury floats are prohibited), float elevations, venting, and visual and audio alarm location.

- (G) Storage tank size, dimensions, riser to grade, and material specifications.
- (H) Dosing siphon.
- (I) Sanitary sewer service line, or force main when a component of a sanitary sewer service line, with minimum pipe slope for the service line, invert elevations at the building and at each component of the wastewater system, and pipe sizes and material specifications.
- (J) Sanitary sewer collection line plan and profile, pipe invert elevations at each component of the wastewater system, and pipe sizes and material specifications.
- (K) Sanitary sewer force main, when a component of a sanitary sewer collection line, plan and profile, pipe sizes and material specifications, and pipe invert elevations at each component of the wastewater system.
- (L) Trench detail for a sanitary sewer service line, sanitary sewer collection line, and force main when a component of a sanitary sewer service line or sanitary sewer collection line.
- (M) Sewer/water crossover detail with invert elevations of the sanitary sewer service line, sanitary sewer collection line, water service line, water service pipe, or water main.
- (N) Manhole or cleanout detail that are included on a sanitary sewer collection line or sanitary sewer service line.
- (O) Distribution box detail with flow equalization devices.
- (P) Vertical cross-section view of the leachfield with bottom trench or bed, invert elevations for distribution piping, at-grade access and clean out ports, and top of field relative to original and proposed ground surface.
- (Q) Sanitary sewer service line or sanitary sewer collection line crossing surface water.
- (R) Proposed curtain drain.
- (S) Erosion prevention and sediment control measures.
- (4) Supporting data and narratives.
 - (A) Calculations for sizing each component of the wastewater system, when required.
 - (B) Flow metering and wastewater strength analysis, when required.
 - (C) Calculations to demonstrate all portions of the bottom of the leachfield maintain the depths of naturally occurring soil and fill material required pursuant to § 1-903 to the seasonal high-water table, induced water table, and bedrock.
 - (D) Hydrogeologic analysis to calculate the induced water table.
 - (E) Soil descriptions identified on the site plan.
 - (F) An application that includes a design of a leachfield based on monitoring of the water table to establish the seasonal high-water table shall include:
 - (i) all water table monitoring data; and
 - (ii) an analysis of the water table monitoring data.
 - (G) Specifications for mound fill material, fill material for sand filters, and bottomless sand filter fill material.
 - (H) Leakage testing procedure and required result for each component of a wastewater system.
 - (I) Innovative/alternative system or component manufacturer and model number, if applicable.

- (J) Specifications on methods of installation, performance standards, and quality of workmanship.
 - (K) Operation and maintenance manuals when required by these Rules.
 - (L) When a constructed wetlands is a component of the wastewater system, a list of plant species.
- (g) For an application proposing a potable water supply, the following additional information shall be provided.
- (1) Required information to be shown on the site plan for a potable water supply with a potable water source.
 - (A) Location of all components of the proposed potable water system.
 - (B) Location of all proposed, existing, or permitted leachfields, replacement areas, and wastewater tanks that are on the applicant's property.
 - (C) Location of all proposed, existing, or permitted leachfields and wastewater tanks and replacement areas that are off the applicant's property but that have an isolation zone identified in § 1-1104(e) that ends 50 feet or less from the proposed potable water source.
 - (D) Isolation zones identified in § 1-1104(e) drawn around all proposed, existing, or permitted leachfields, replacement areas, and wastewater tanks identified in Subsection (e)(1)(B) and (C).
 - (E) Location and identification of all potential sources of contamination identified in Table 11-1 that are on the applicant's property or that are off the applicant's property but have an isolation distance that ends 50 feet or less from the proposed potable water source.
 - (F) Ledge outcrops and other site limitations that may interfere with the proper installation of the components of the potable water supply.
 - (G) Existing or permitted potable water supplies or public water supplies within the isolation distances for interference testing.
 - (2) Required information to be shown on the site plan for a potable water supply that is a water service line or a water service pipe.
 - (A) Location of sanitary sewer collection lines or sanitary sewer service lines that are on the applicant's property and location of sanitary sewer collection lines or sanitary sewer service lines that are off the applicant's property but within 50 feet of the applicant's nearest property line.
 - (B) Elevations and material specifications of the sanitary sewer collection line or sanitary sewer service line when:
 - (i) a water service line or water service pipe crosses a sanitary sewer collection line or sanitary sewer service line; or
 - (ii) a water service line or water service pipe is within the horizontal isolation distance to a sanitary sewer collection line or sanitary sewer service line.
 - (3) Plans with details for components of a potable water supply.
 - (A) Preparer's signature, plan title, date, and revision date(s) on all plans.
 - (B) Well construction and material specifications.
 - (C) Water service pipe or water service line size and material specifications.
 - (D) Water service pipe or water service line trench and material specifications.
 - (E) Potable water system treatment components and material specifications, if treatment is included in the design.

- (F) Storage tank size, dimensions, riser to grade, overflow, and material specifications.
- (G) Water service pipe or water service line crossing surface water.
- (4) Supporting data and narratives.
 - (A) Calculations for sizing each component of the potable water supply, when required.
 - (B) Determining the long-term yield for potable water sources if required for the potable water supply.
 - (C) Calculations for determining the instantaneous peak demand if required for the potable water supply.
 - (D) Calculations for determining water storage if determining storage is required for the potable water supply.
 - (E) Water quality testing results.
 - (F) Flow metering analysis, when required.
 - (G) Well yield and method for determining the yield.
 - (H) Pressure and leakage testing of distribution system.
 - (I) Disinfection specifications for disinfecting potable water supply.
 - (J) Water system treatment components with manufacturer's make and model numbers, if treatment is included in the design.
 - (K) Surrounding well logs to demonstrate availability of water.
 - (L) Interference testing and analysis when required.
 - (M) Pump manufacturer with pump capabilities and model number.
 - (N) Specifications on methods of installation, performance standards, and quality of workmanship.
 - (O) Operation and maintenance manuals.

Appendix B – Examples

Examples B-1 Examples for Designing a Flow Equalization Tank

Example 1: The project discharges 1000 gallons per day on Friday and Saturday and 200 gallons per day for the other five days. Total flow is 3,000 gallons and is discharged over 7 days at 429 gallons per day.

Example 1 Table

Day	Flow into system	Flow out of system	Storage
1	1000	429	571
2	1000	429	1,142
3	200	429	913
4	200	429	684
5	200	429	455
6	200	429	226
7	200	429	0

The maximum storage per the table is 1142 gallons.

The system needs a storage tank of $1,142 \times 1.5 = 1,713$ gallons.

Example 2: The project discharges 1000 gallons per day on Monday and on Thursday and 200 gallons per day the other five days. Total flow is 3,000 gallons and is discharged over 7 days at 429 gallons per day.

Example 2 Table

Day	Flow into system	Flow out of system	Storage
1	1000	429	571
2	200	429	342
3	200	429	113
4	1000	429	684
5	200	429	455
6	200	429	226
7	200	429	0

The maximum storage per the table is 684 gallons.

The system needs a storage tank of $684 \times 1.5 = 1026$ gallons.

Examples B-2 Examples for Calculating the Induced Water Table Using the Simplified Method

Example 1: Calculate the linear loading rate (LLR) for the design of a mound for a 3-bedroom single-family residence with the following basis of design.

The design flow (DF) is 420 gallons per day (gpd). The site has 13 inches of a sandy loam over 10 inches of a silt loam. The sandy loam and silt loam have consistencies less dense than “firm.” Seasonal high-water table is at 23 inches. The ground slope where the leachfield is proposed is 5 percent. The designer may use only the 13 inches of the sandy loam (the silt loam becomes the limiting soil condition); use the silt loam if the design is to use the 23 inches above the seasonal high-water table; or use both soil textures. These Rules require 6 inches of naturally occurring soil between ground surface and the induced water table.

- (1) Calculate the LLR and System Length Based Solely on the Available Depth of Sandy Loam.

Calculate the LLR:

$$(h) = (13 \text{ inches} - 6 \text{ inches}) \div 12 \text{ inches per foot} = 0.58 \text{ feet}$$

$$(f) = 18.7 \text{ (from Table 9-12 for a sandy loam with a 5 percent slope)}$$

$$\text{LLR} = (h)(f) = (0.58)(18.7) = 10.8 \text{ gallons per linear foot}$$

Calculate the minimum system length (SL)

$$\text{SL} = \text{DF} \div \text{LLR}$$

$$\text{SL} = 420 \text{ gpd} \div 10.8 \text{ gallons per linear foot}$$

$$\text{SL} = 39 \text{ feet}$$

- (2) Calculate the LLR and System Length Based on the Most Limiting Soil or Silt Loam.

Calculate the LLR:

$$(h) = (13 \text{ inches} + 10 \text{ inches} - 6 \text{ inches}) \div 12 \text{ inches per foot} = 1.4 \text{ feet}$$

$$(f) = 3.7 \text{ (from Table 9-12 for a silt loam with a 5 percent slope)}$$

$$\text{LLR} = (h)(f) = (1.4)(3.7) = 5.18 \text{ gallons per linear foot}$$

Calculate the minimum system length (SL):

$$\text{SL} = \text{DF} \div \text{LLR}$$

$$\text{SL} = 420 \text{ gpd} \div 5.18 \text{ gallons per linear foot}$$

$$\text{SL} = 81 \text{ feet}$$

- (3) Calculate the LLR and System Length Based on the 2 Textures of Sandy Loam and Silt Loam.

According to § 1-927(j), the LLR using 2 textures is:

LLR for the Sandy Loam + LLR for the Silt Loam

$$\text{LLR for the Sandy Loam} = [(13 \text{ inches} - 6 \text{ inches}) \div 12 \text{ inches}](18.7) = 10.8 \text{ gallons per linear foot}$$

$$\text{LLR for the Silt Loam} = (10 \text{ inches} \div 12 \text{ inches})(3.7)$$

$$\text{LLR} = 3.1$$

$$\text{System LLR} = 10.8 \text{ gallons per linear foot} + 3.1 \text{ gallons per linear foot}$$

$$\text{System LLR} = 13.9 \text{ gallons per linear foot}$$

Calculate the minimum system length (SL)

$$\text{SL} = \text{DF} \div \text{LLR}$$

$$SL = 420 \text{ gpd} \div 13.9 \text{ gallons per linear foot}$$

$$SL = 30 \text{ feet}$$

Example 2: Calculate the linear loading rate (LLR) for the design of a mound for a 3-bedroom single-family residence with the following basis of design.

The design flow (DF) is 420 gallons per day (gpd). The site has 10 inches of a silt loam over 13 inches of a sandy loam. The silt loam and sandy loam have consistencies less dense than “firm.” Seasonal high-water table is at 23 inches. The ground slope where the leachfield is proposed is 5 percent. The designer may use only the 10 inches of the silt loam (the sandy loam becomes the limiting soil condition); use the silt loam if the design is to use the 23 inches above the seasonal high-water table; or use both soil textures. These Rules require 6 inches of naturally occurring soil between ground surface and the induced water table.

- (1) Calculate the LLR and System Length Based Solely on the Available Depth of Silt Loam.

Calculate the LLR:

$$(h) = (10 \text{ inches} - 6 \text{ inches}) \div 12 \text{ inches per foot} = 0.33 \text{ feet}$$

$$(f) = 3.7 \text{ (from Table 9-12 for a silt loam with a 5 percent slope)}$$

$$LLR = (h)(f) = (0.33)(3.7) = 1.2 \text{ gallons per linear foot}$$

Calculate the minimum system length (SL)

$$SL = DF \div LLR$$

$$SL = 420 \text{ gpd} \div 1.2 \text{ gallons per linear foot}$$

$$SL = 350 \text{ feet}$$

- (2) Calculate the LLR and System Length Based on the 2 soil textures. Since the silt loam soil has an f-factor that is less than the underlying layer of sandy loam soil, the LLR shall be based on the f-factor for the silt loam soil.

Calculate the LLR:

$$(h) = (10 \text{ inches} - 6 \text{ inches} + 13 \text{ inches}) \div 12 \text{ inches per foot} = 1.4 \text{ feet}$$

$$(f) = 3.7 \text{ (from Table 9-12 for a silt loam with a 5 percent slope)}$$

$$LLR = (h)(f) = (1.4)(3.7) = 5.18 \text{ gallons per linear foot}$$

Calculate the minimum system length (SL):

$$SL = DF \div LLR$$

$$SL = 420 \text{ gpd} \div 5.18 \text{ gallons per linear foot}$$

$$SL = 81 \text{ feet}$$

Appendix C – Typical Details and Examples

Figure C-1 Example of 50-foot Calculation for Reconstruction

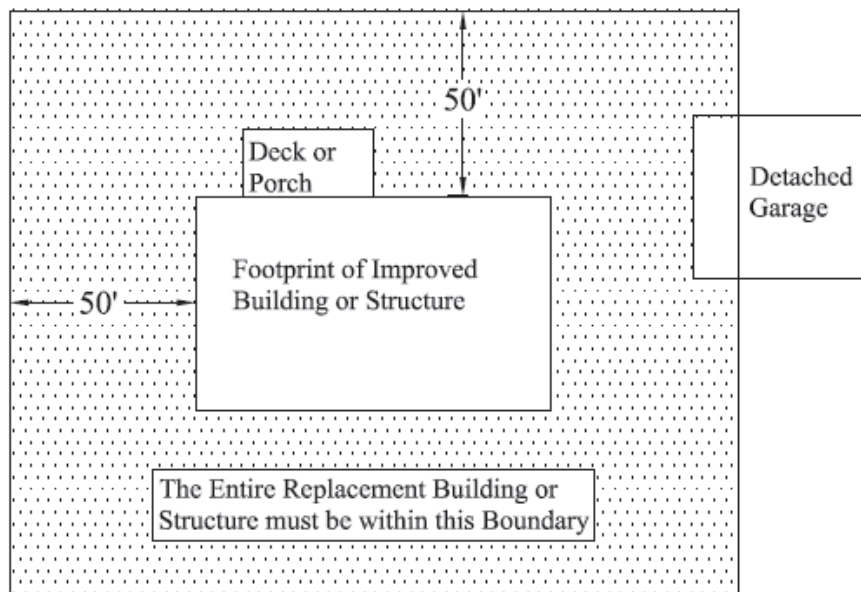
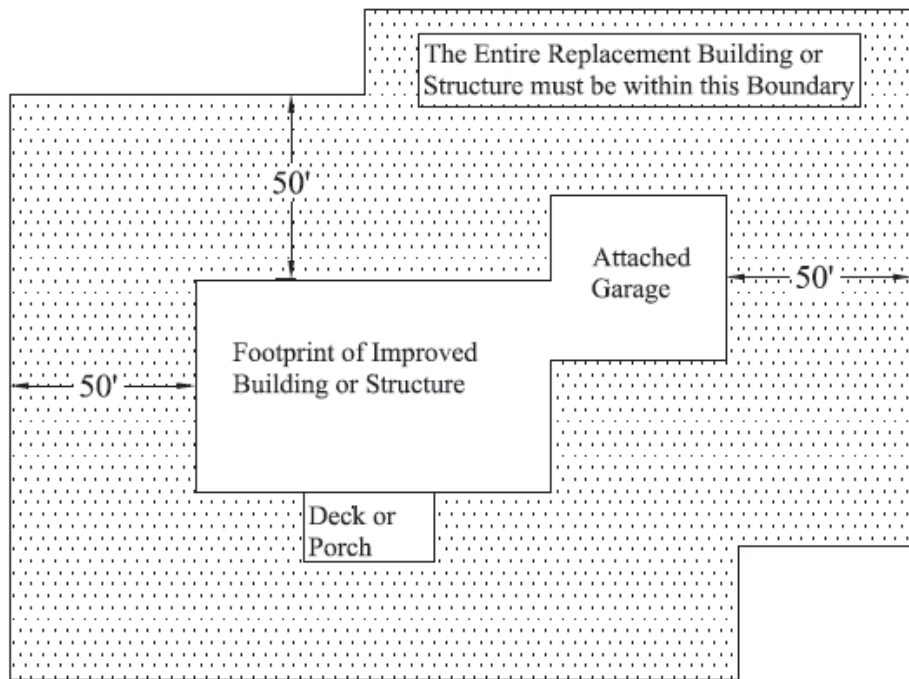

Figure C-2 Detail of Typical Groundwater Monitoring Well

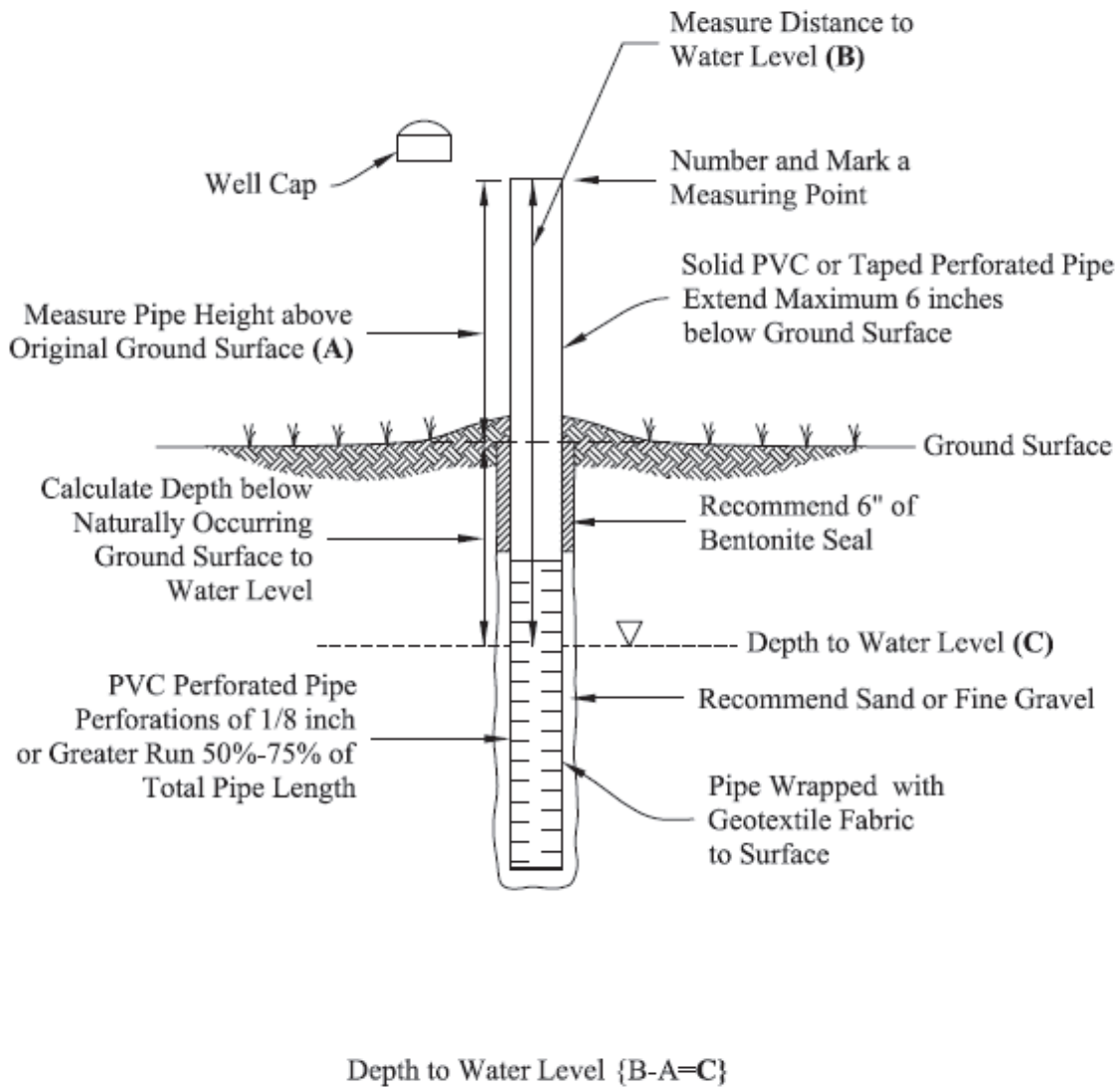

Figure C-3 Detail of Typical Site that was Re-Graded

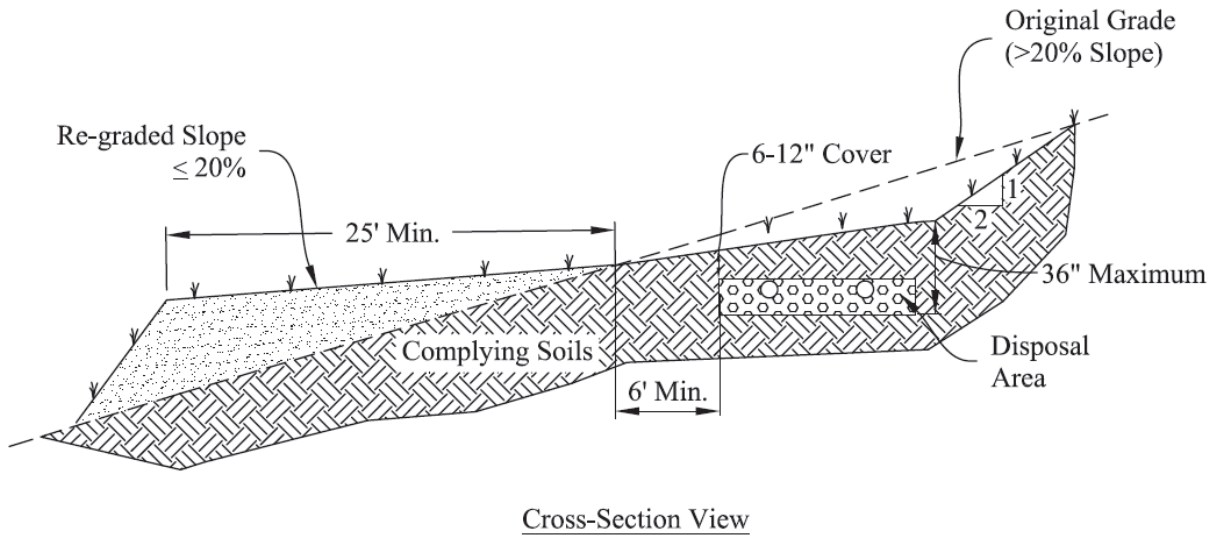

Figure C-4 Example for Drawing Isolation Zone Around a Drinking Water Source

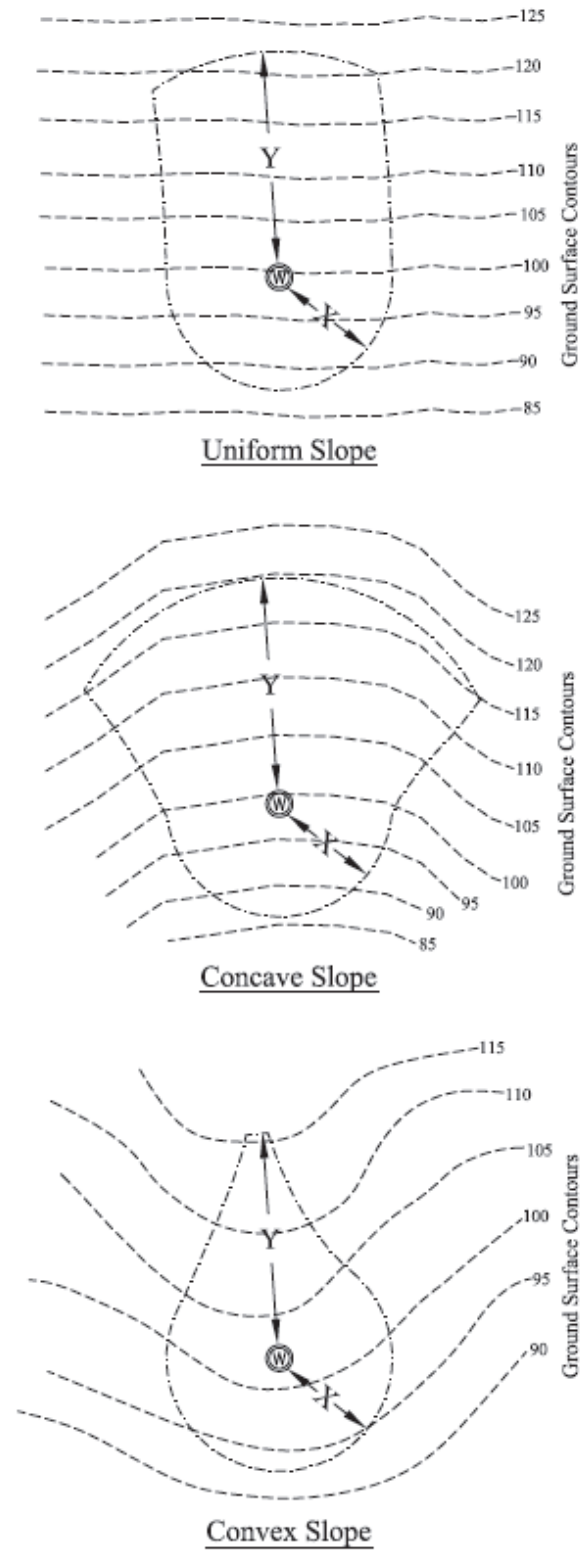

Figure C-5 Detail of Typical Time Dosing Pump Station

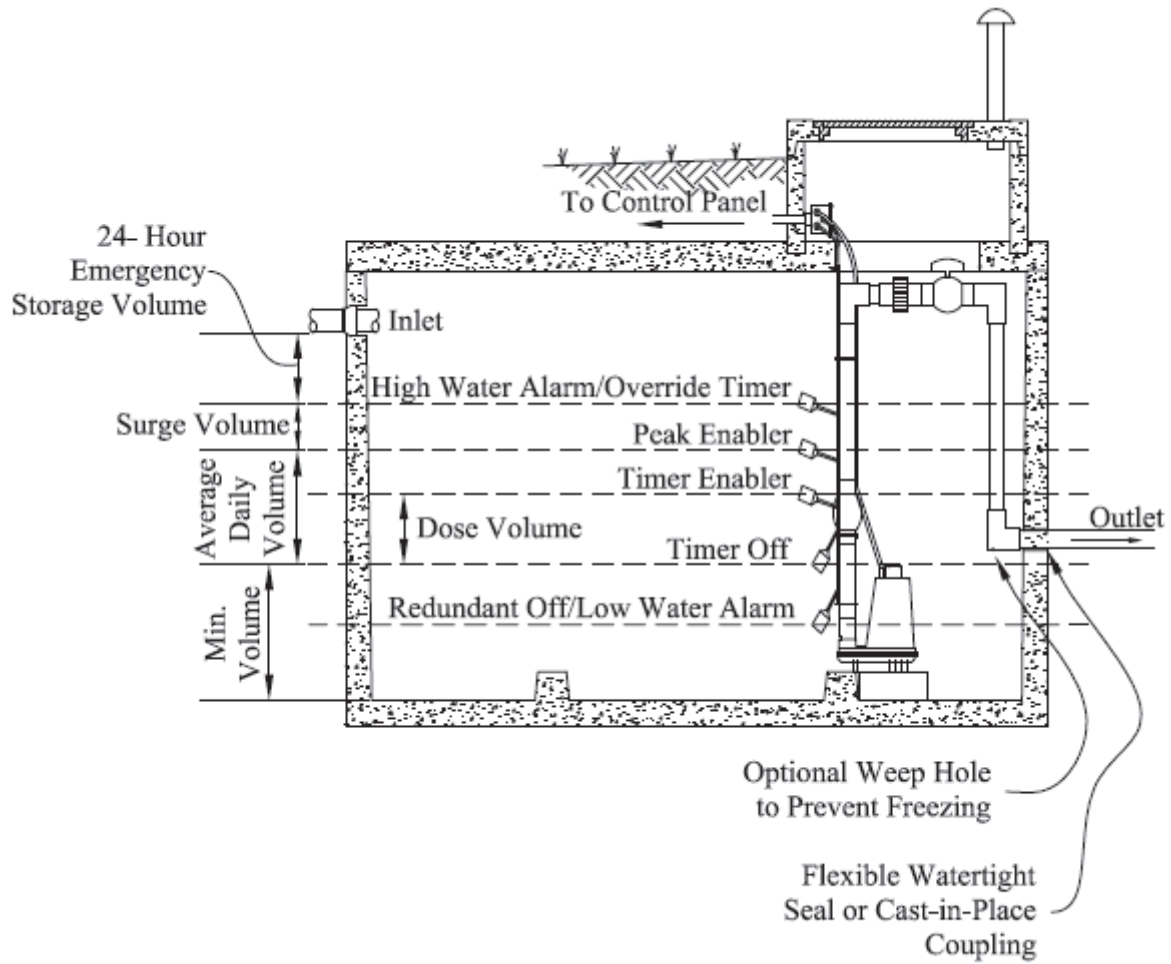
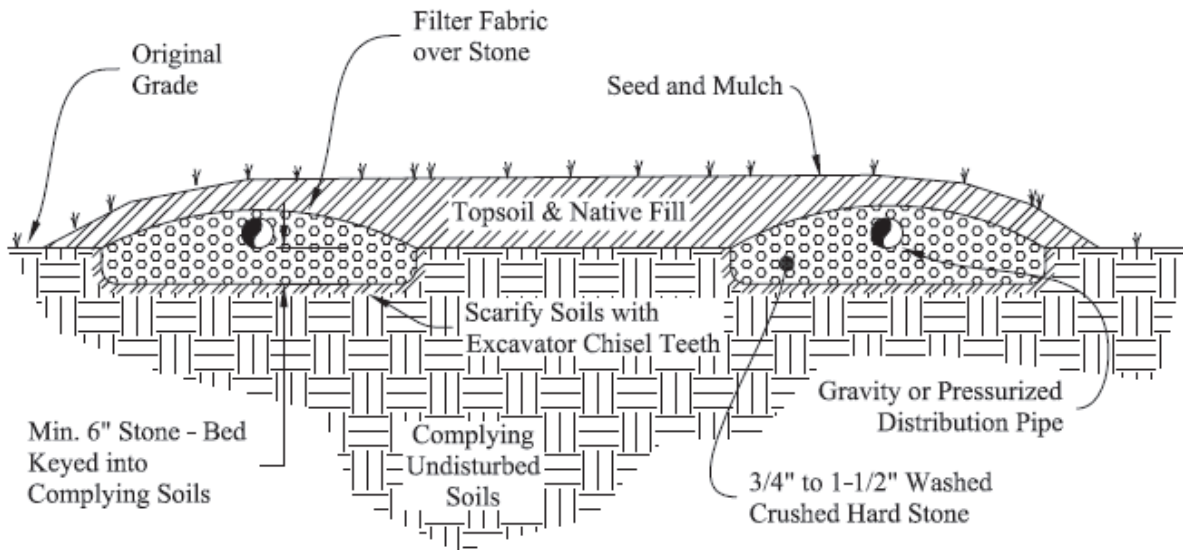

Figure C-6 Detail of Typical Shallow Trench Wastewater System



Cross-Section View

Bottom of Stone:
 Min. 3' to Seasonal High Water Table,
 Impervious Soils
 Min. 4' to Bedrock

Figure C-7 Detail of Typical Trench Wastewater System With 24 Inches of Limiting Soil

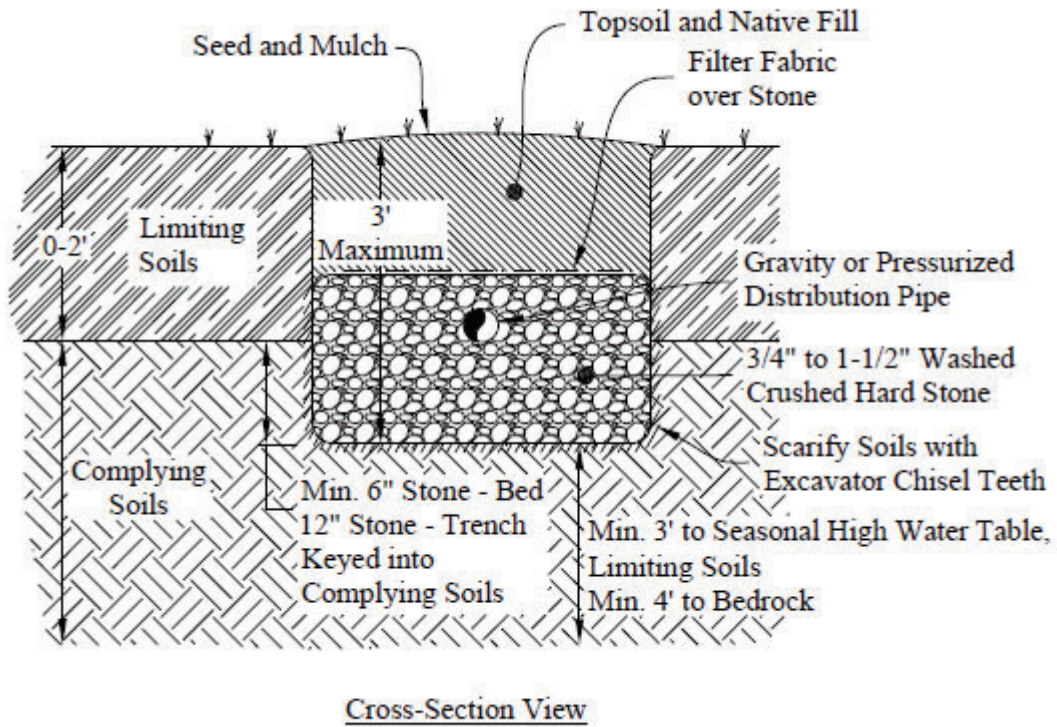
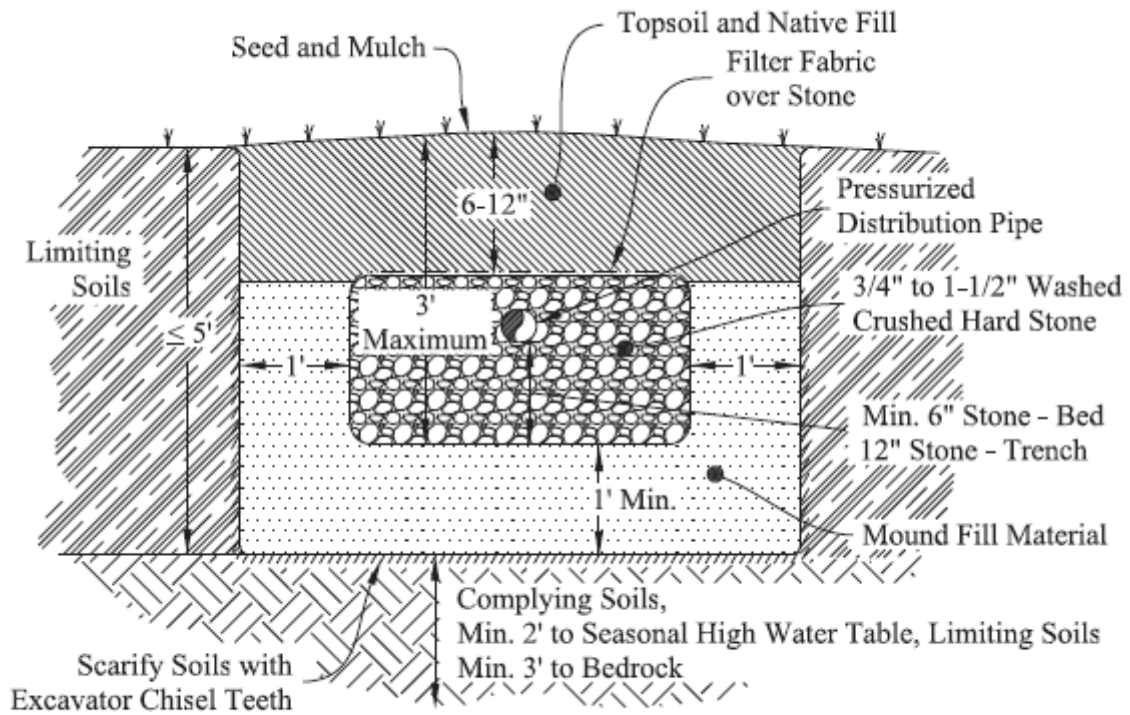

Figure C-8 Detail of Typical Trench Wastewater System With 24 Inches to 5 Feet of Limiting Soil



Cross-Section View

Figure C-9 Detail of Typical At-Grade Leachfield with One Infiltration Area (0-3 % Site Slope)

- A: Effective Infiltration Area (min. of 6" stone) (3'-6')
- B: Side Slope (3:1 max.)
- L: System Length
- W: System Width

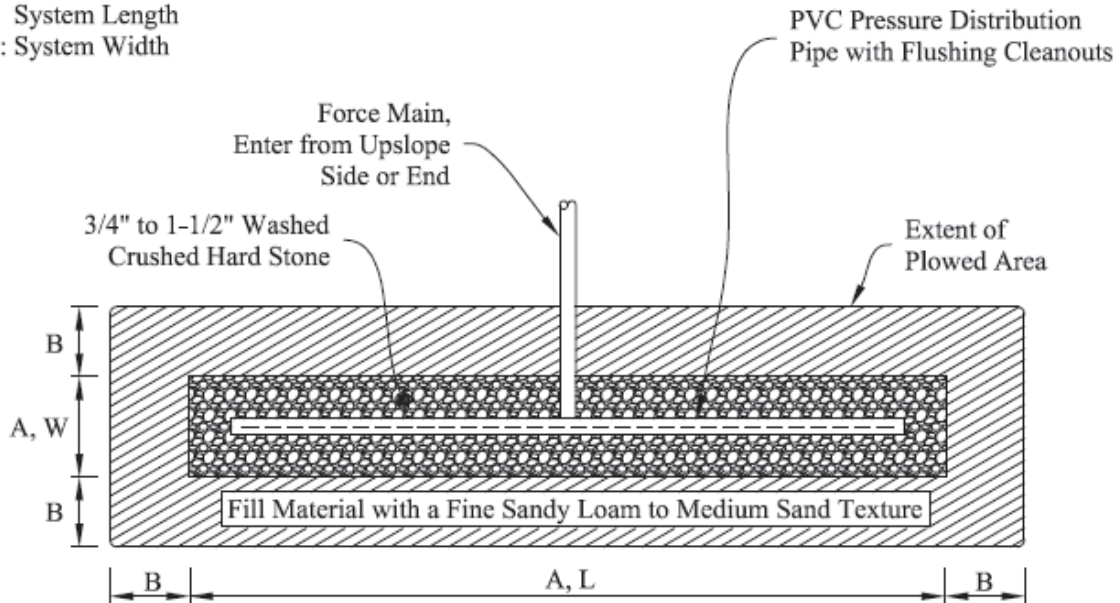

Plan View

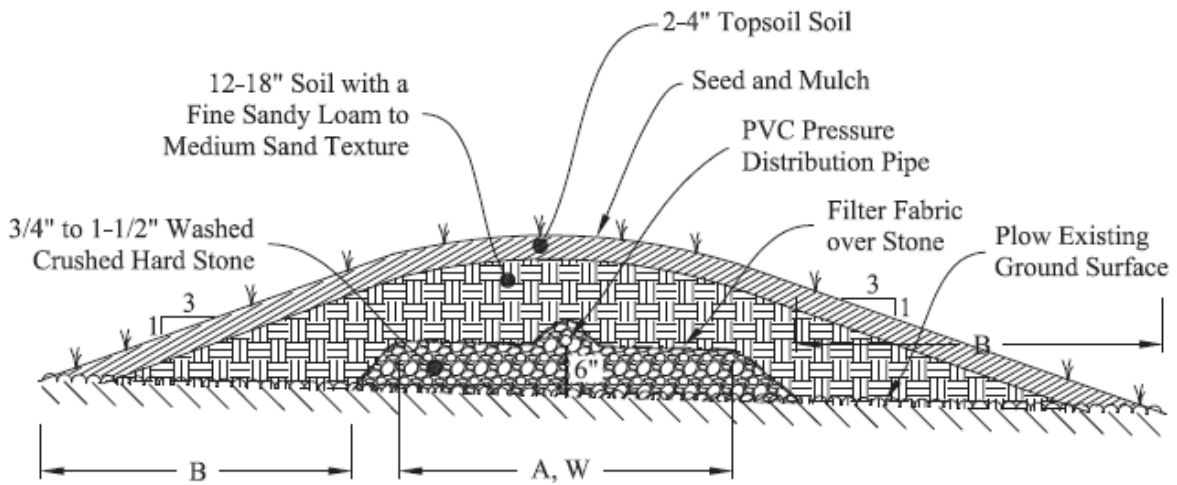

Cross-Section View

Figure C-10 Detail of Typical At-Grade Leachfield with Two Infiltration Areas (> 3 % Site Slope)

A: Effective Infiltration Area (min. of 6" stone) (3'-6")
 B: Side Slope (3:1 max.)
 L: System Length
 W: System Width

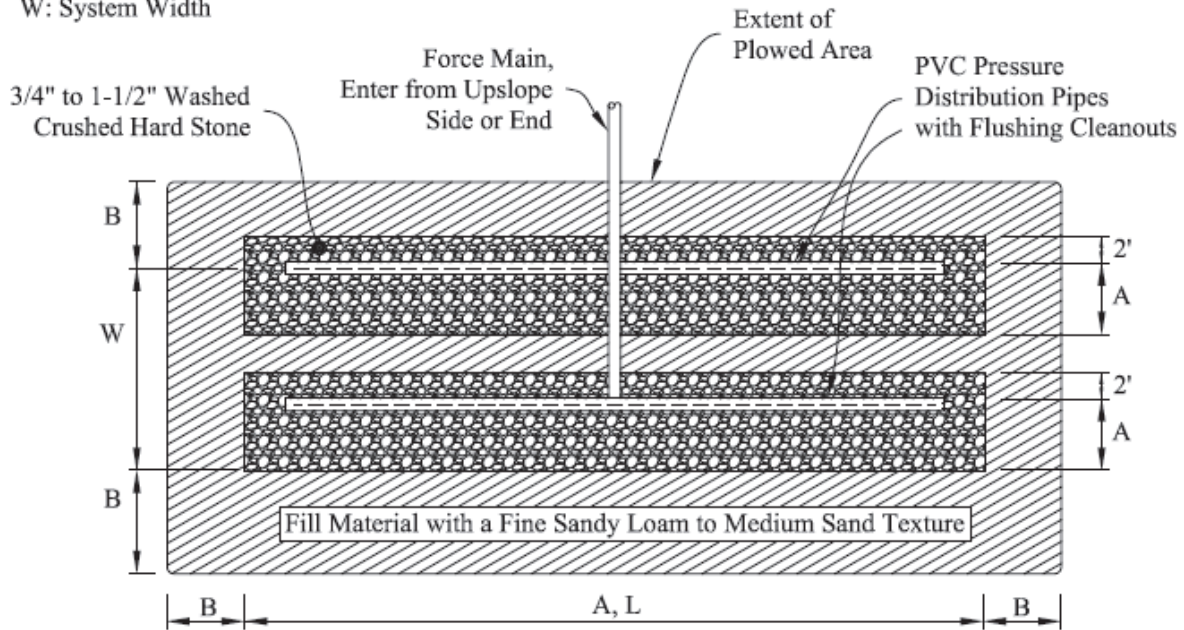

Plan View

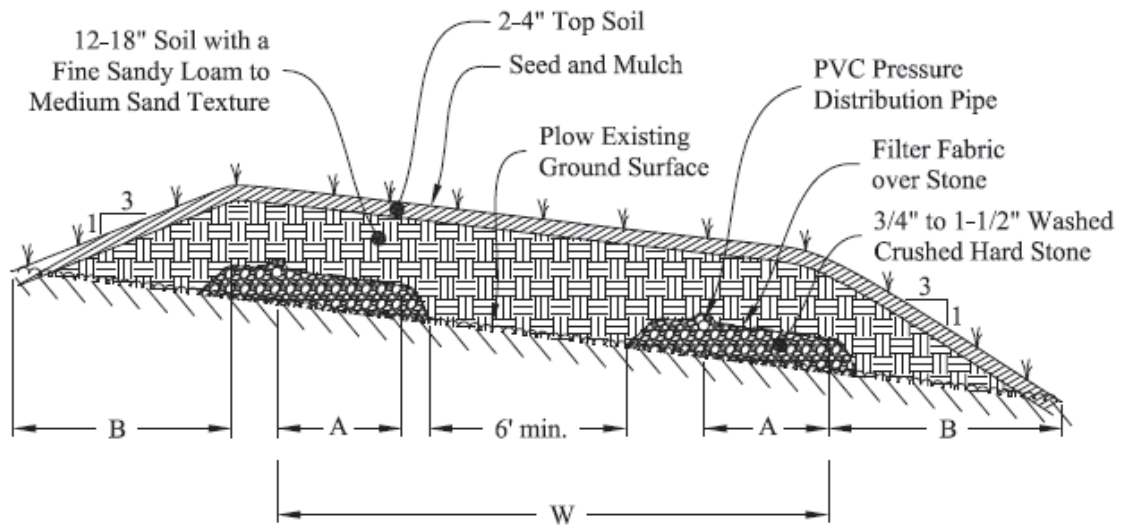

Cross-Section View

Figure C-11 Detail of Typical At-Grade Leachfield with Interfingering Infiltration Areas (> 3 % Site Slope)

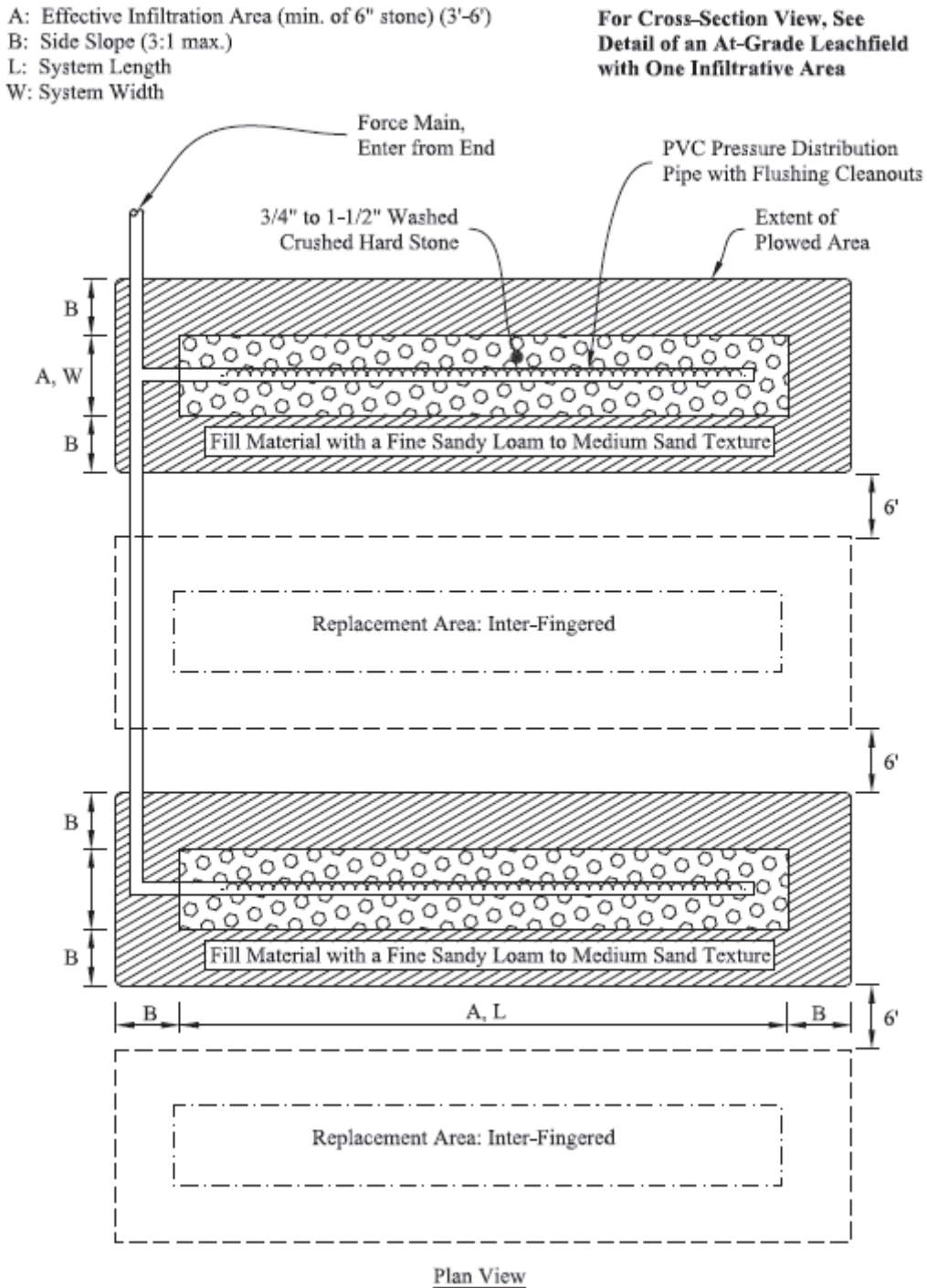
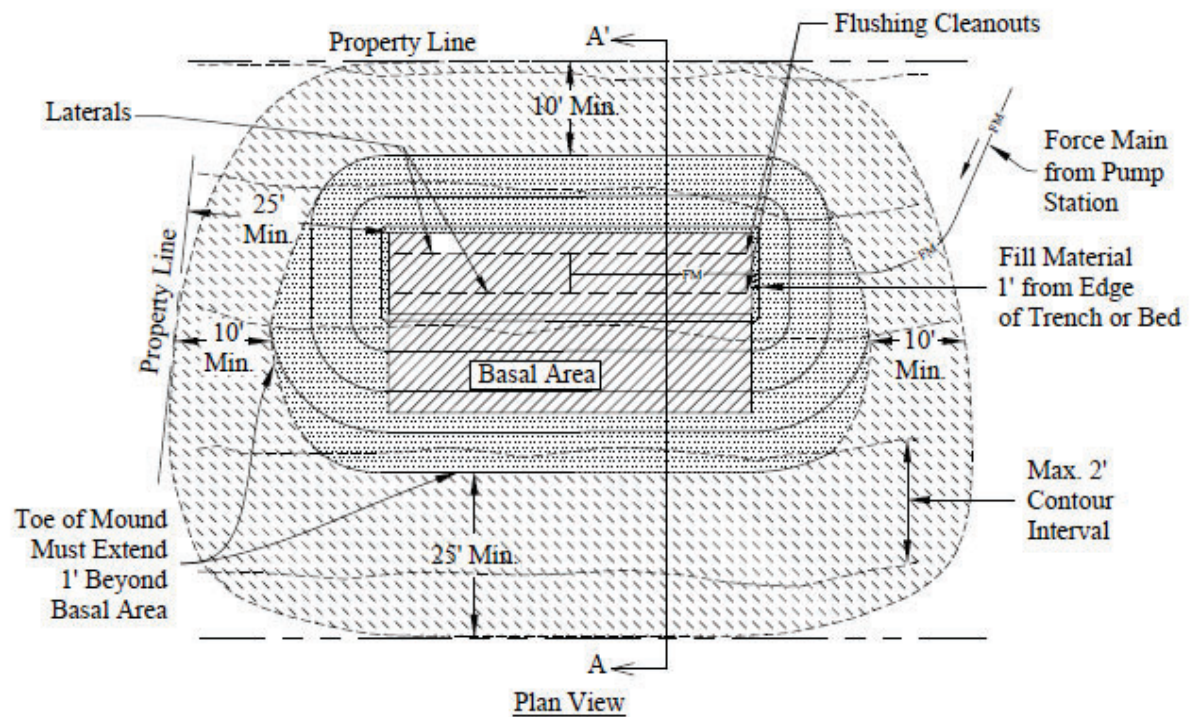





Figure C-12 Detail of Typical Bed in a Mound



-  Extent of Naturally Occurring Soils that Meet the Minimum Site Conditions
-  Mound Fill Material
-  Native Soil Cover with 2-4" Topsoil to be Seeded and Mulched
-  Basal Area

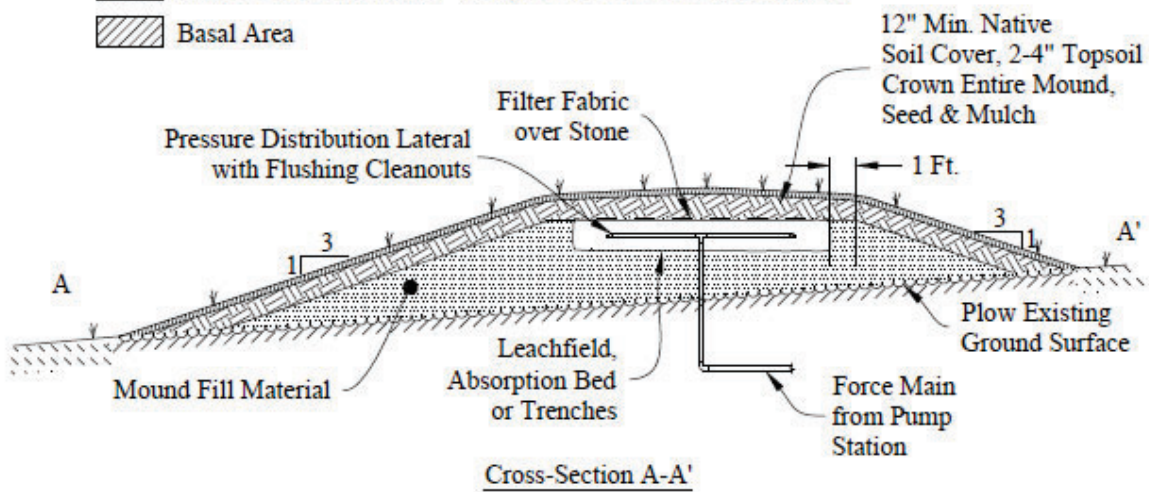

Figure C-13 Detail of Typical Leachfield in a Bottomless Sand Filter

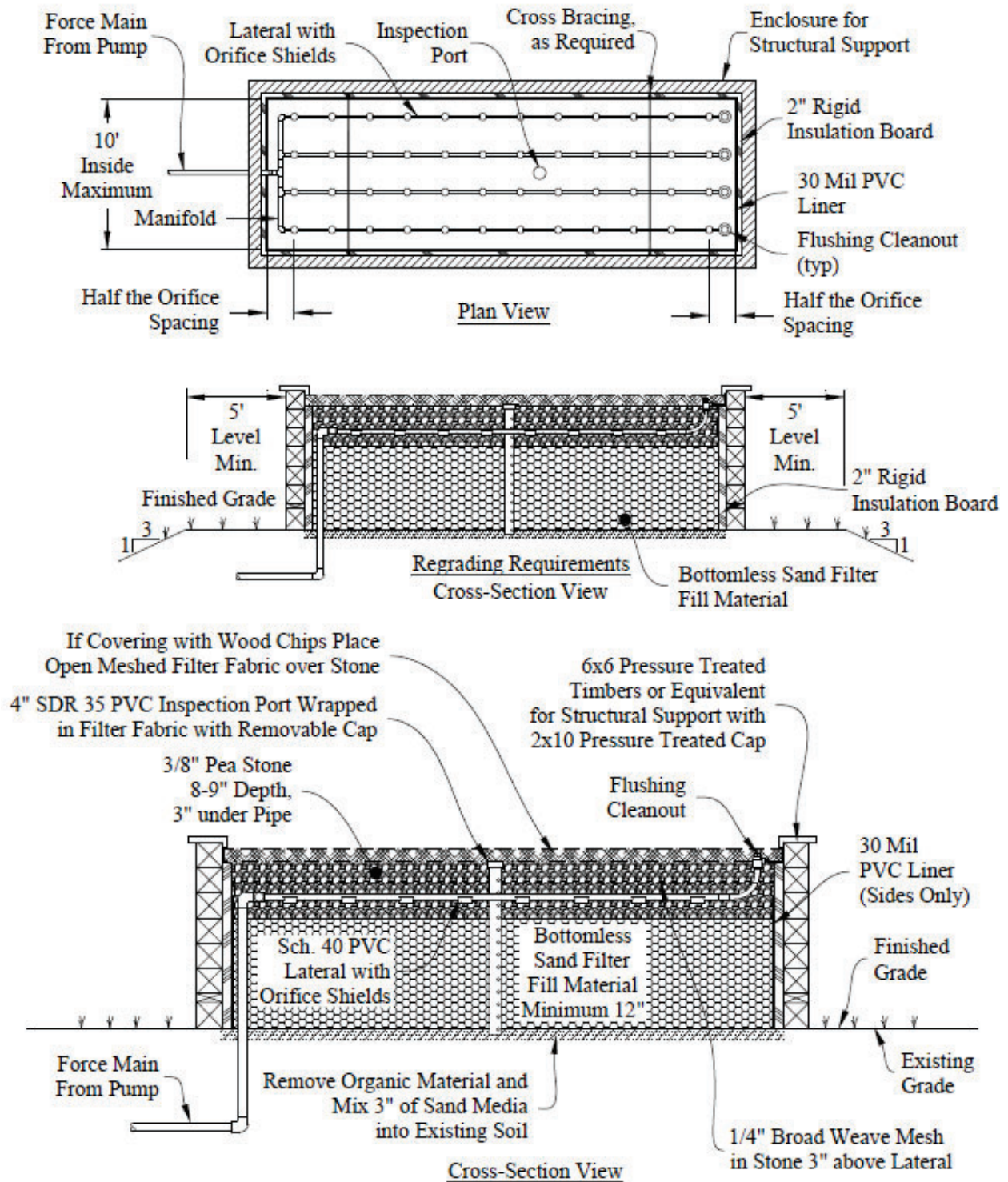
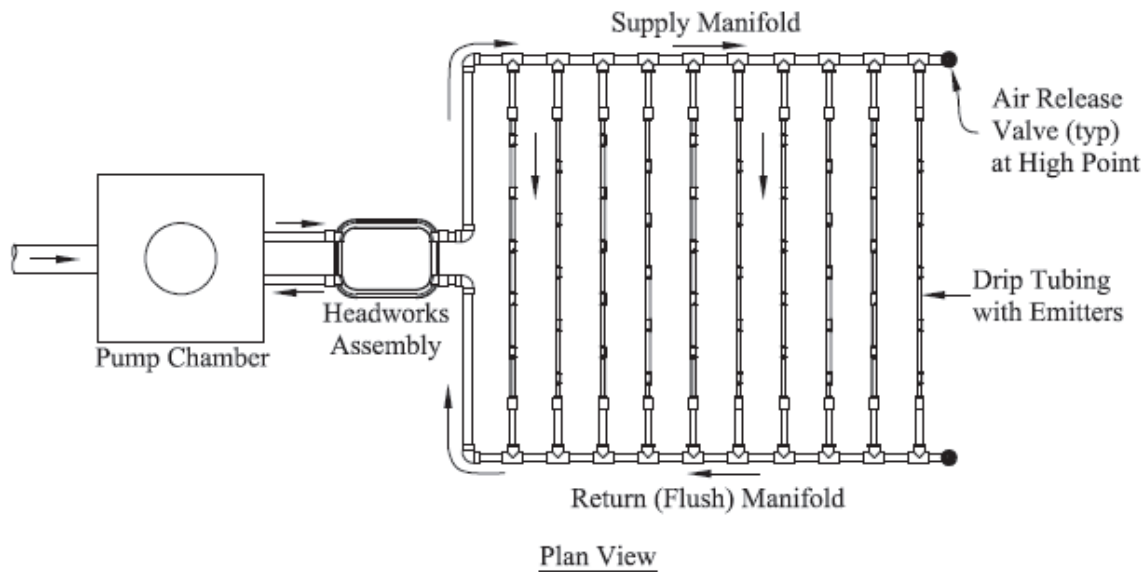

Figure C-14 Detail of Typical Leachfield using Subsurface Drip Distribution



Typical Subsurface Drip Distribution - Two Zones

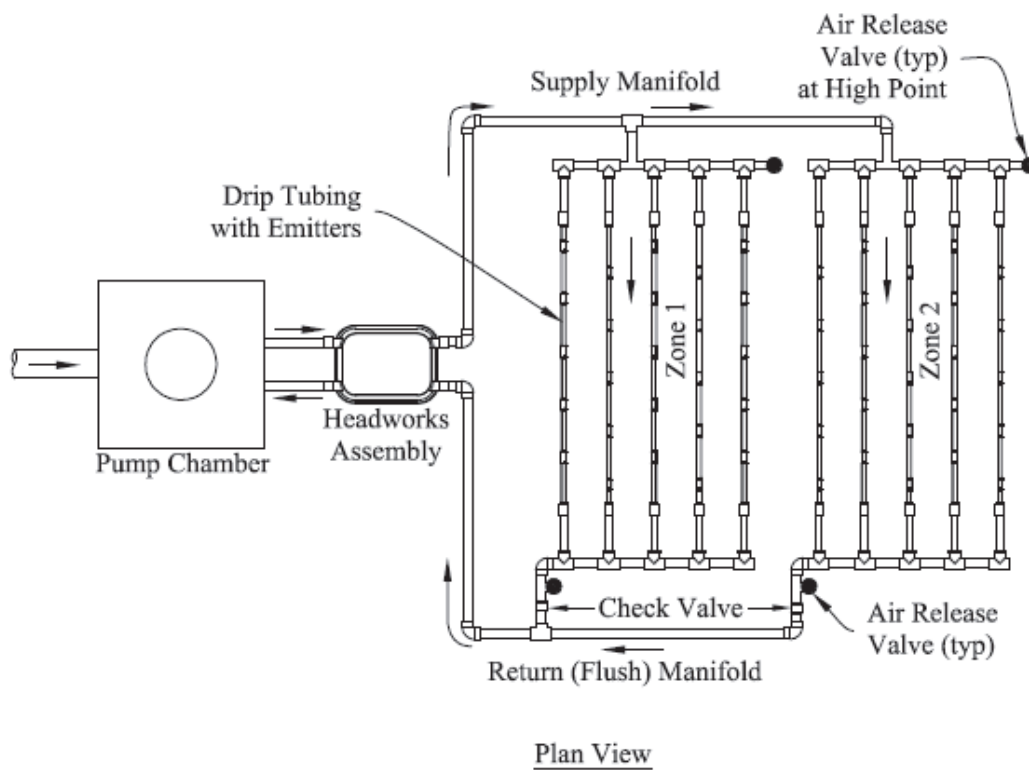

Figure C-15 Example for Drawing Isolation Zone Around a Leachfield

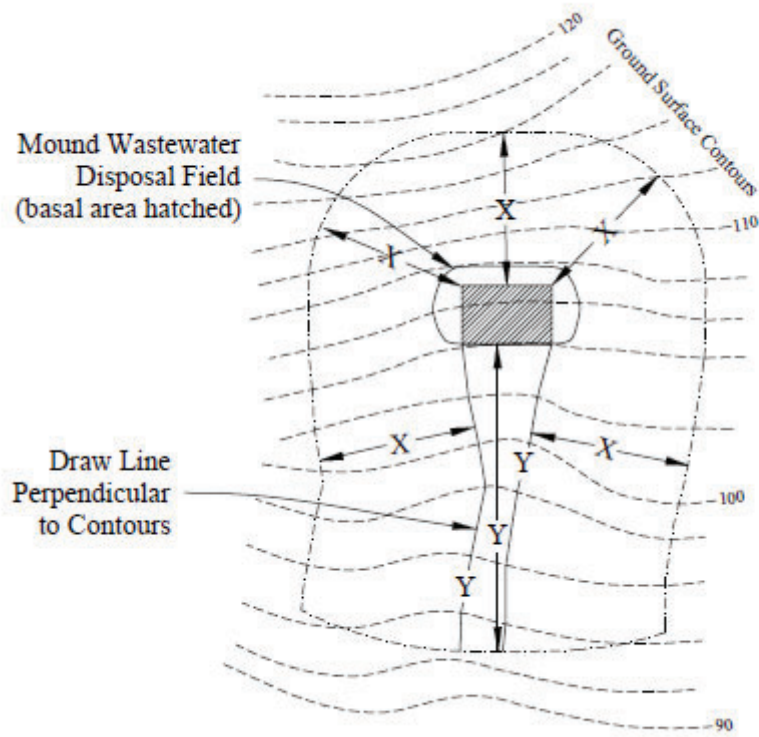

Figure C-16 Detail of Typical Drilled Bedrock Well

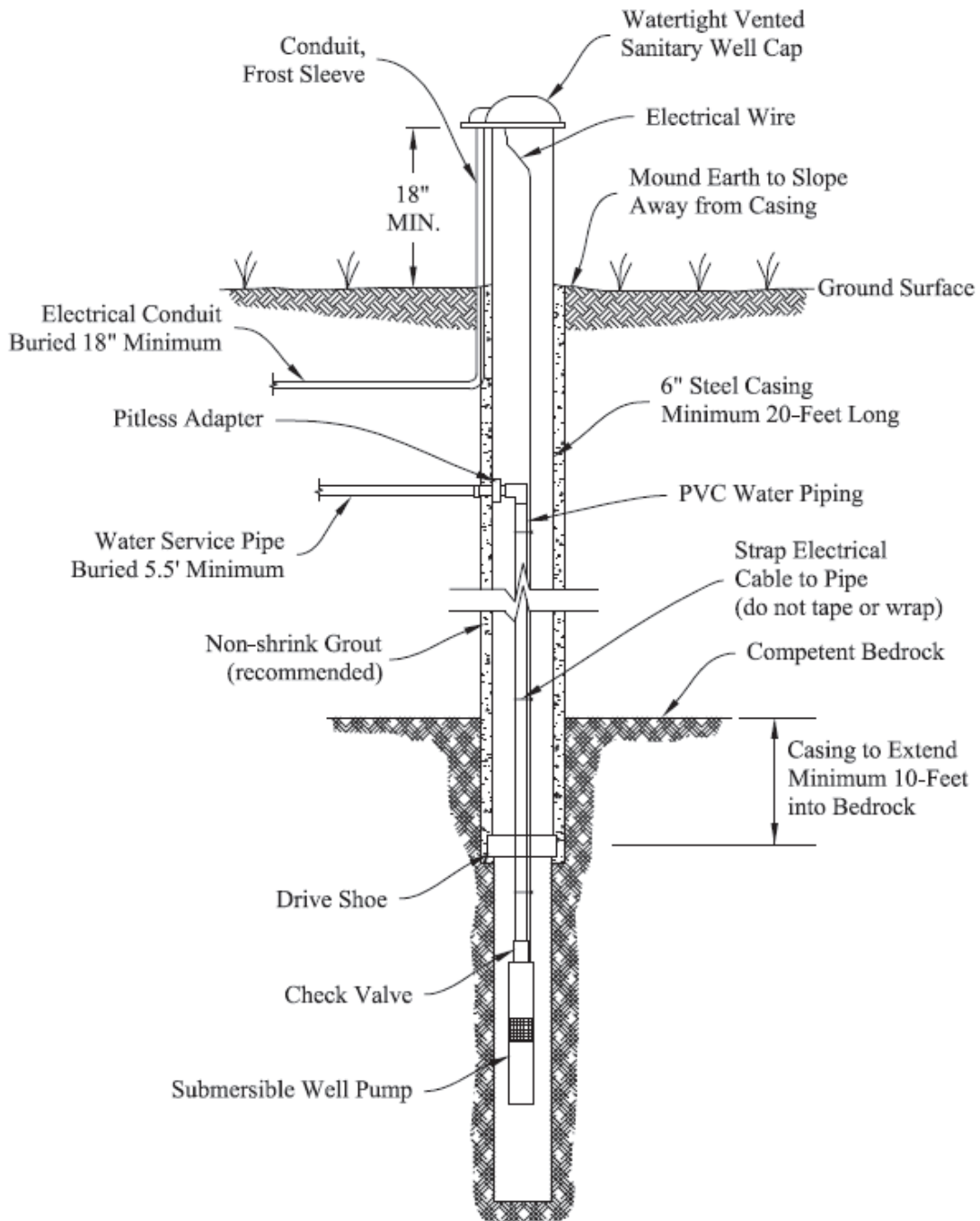

Figure C-17 Detail of Typical Driven Well

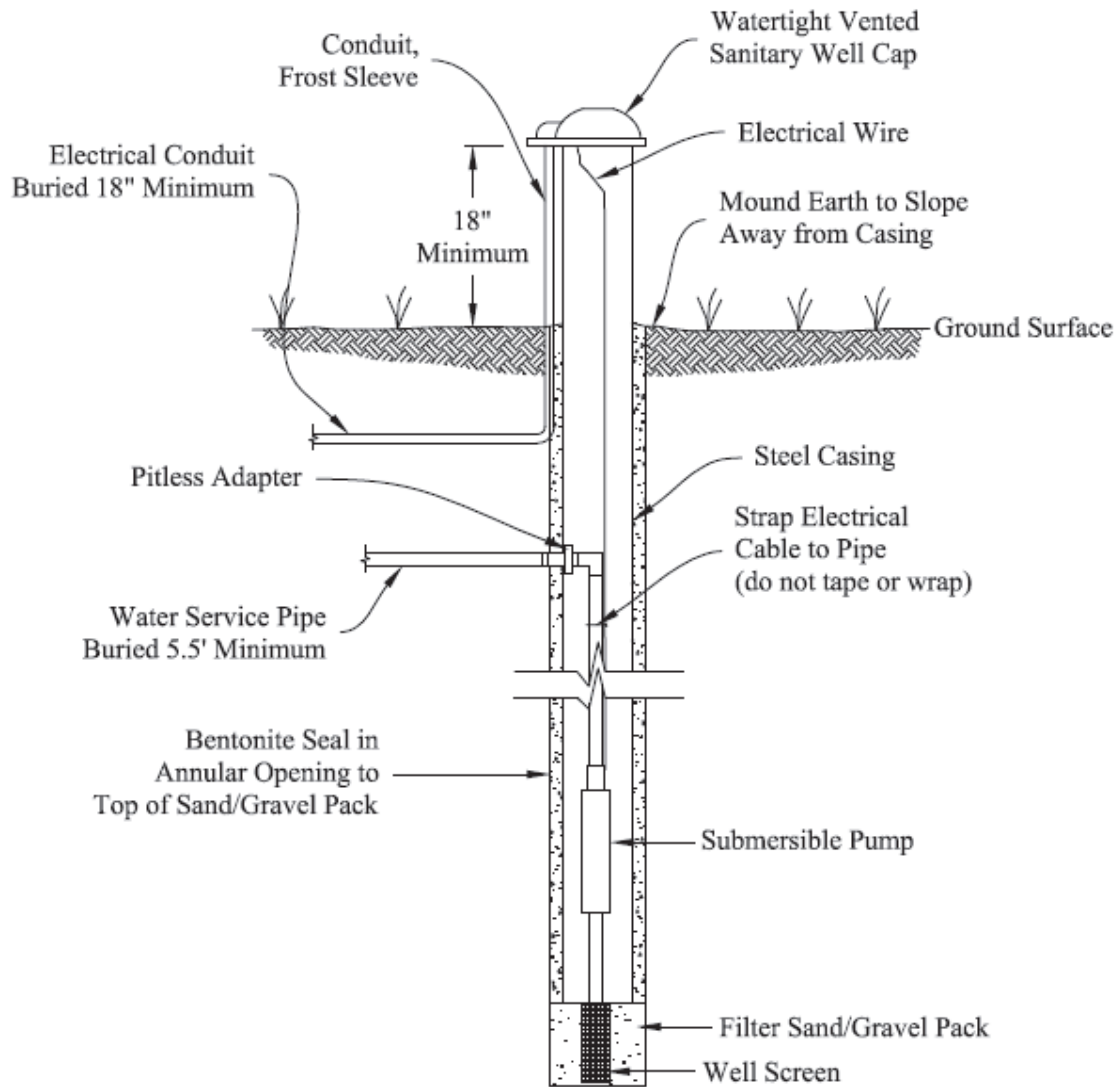

Figure C-18 Detail of a Typical Dug Well or Spring

